

# *An ecological approach to sanitation in Africa - A compilation of experiences*

In sending you this CD my aim is simple – to pass on the knowledge I have gained during a period of researching the topic known as ecological sanitation – a method which involves recycling human excreta. It is an attempt to make “eco-san” simple and cost-effective for use by low income communities in Africa. The ultimate aim is to form much stronger links between sanitation, agriculture and food production that actually work in practice, and can benefit the users beyond the requirement of providing a toilet alone. It also aims to demonstrate that effective toilets for use in Africa can be built by a family with very little support from outside. I have also attempted to place shallow pit composting eco-toilets under the umbrella of ecological sanitation, as the pit latrine is the most commonly used toilet in Africa, and is likely to remain so for some time. It makes sense therefore to form stronger links between eco-san and existing well established systems like the pit toilet. The work also describes simple urine diversion systems, which are more familiar in programmes promoting eco-san. No attempt has been made here to describe the full range of eco-sanitary options or programmes, which are described in detail elsewhere. This work describes personal experiences only. It has become clear to me that this story of eco-san is exciting and may have far reaching implications in the future. It adds new dimensions to the rather drab story of conventional sanitation and offers ways to overcome several existing problems.

The work which backs up this document is recorded in many hundreds of research files and a number of research manuals. This particular CD version is a simplified version of the original. For practical field use, this sort of work is best written down and distributed in the form of a book or specific booklets. Books or booklets can be thrown into a bag and referred to at any time. CD's cannot. But the contents of this CD, or parts of it, can be transformed into hard copy, by printing, and the reader is encouraged to do this. The aim is put the fruits of this work into practice. The work can and should be adapted to suit local conditions – it is the basic principles which are most important. The CD format also provides the opportunity to add new material from time to time, because it is the nature of research and development work that new results and information come in all the time. There is a constant need for updating. This particular version is based on knowledge gained by September 2004. New work is currently being undertaken on the application of toilet compost and urine to maize and vegetable crops in the field and will be added to a later version of this CD. Please copy this CD and pass on to others who may find its contents useful. Four Power Point presentations have also been added to this CD (not on the website), as these provide a convenient method of conveniently absorbing much of the information presented in the main text.

This CD has files for the CD jacket cover, main Book cover, Table of contents, Acknowledgements, Appendix (The *Arborloo* Book and the Compost Toilet Starter Kit) and Bibliography.

The 14 chapters of the book have the following titles.

- 1. An introduction - Understanding the concept of ecological sanitation**
- 2. The answer lies in the soil**
- 3. Modifications of the pit toilet**
- 4. How to build and manage the *Arborloo***
- 5. How to build and manage the *Fossa alterna***
- 6. A question of health**
- 7. The eco-toilet and agriculture**
- 8. The *Arborloo* and growing trees**
- 9. The *Fossa alterna* & the vegetable garden**
- 10. The usefulness of urine**
- 11. Urine diversion – how to build and manage a single vault composting toilet**
- 12. Gardening techniques that assist eco-san supported vegetable production**
- 13. Some special constructional techniques**
- 14. Summing up**

This work is primarily intended for South-Eastern and East Africa, where the climate is warm, and the need for low cost approaches in sanitation desperate. It may also have application for other parts of Africa, and possibly some other parts of the developing world.

## Acknowledgements

The material presented in this text has been abstracted and edited from earlier materials written by the author, mostly in reports and a series of four books entitled *Ecological Sanitation in Zimbabwe*.

Many people have offered me support and encouragement during my personal venture into the world of ecological sanitation. In Zimbabwe I am much indebted to the staff of the Friend Foundation, in particular Mrs Christine Dean and Baidon Matambura for offering an excellent testing ground for prototypes. Marianne Knuth is much thanked for her support and enthusiasm in ongoing training activities at Kufunda Village Training Centre. Annie Kanyemba is also thanked for her most valuable assistance not only in construction, but also in grass roots training activity. Jim and Jill Latham of the Eco-Ed Trust are much thanked for teaching me about permaculture and organic gardening and also making available a valuable testing ground for more prototypes in Mutorashanga. Ephraim Chimbunde, Edward Guzha and David Proudfoot of Mvuramanzi Trust are thanked for their efforts in promoting eco-san in Zimbabwe. I also wish to thank Frank Fleming and Ilona Howard of Clinical Laboratories for the bacteriological testing of soil samples derived from various eco-toilets. I am most grateful for the help, encouragement and collaboration with WaterAid, particularly Ned Breslin in Mozambique and Steven Sugden in Malawi. These two countries have provided a source of encouragement and stimulation in the promotion of low cost eco-san. From Malawi I also wish to thank Mbachi Msomphora, Boyce Nyirena, Nelly Magelegele and Shadreck Chimangansasa from WaterAid, Twitty Mukundia from CCAP, and Garry Holm and Elias Chimulambe from COMWASH, Thyolo. Mike McGarry of COWATER is also thanked for his encouragement. I also wish to thank Obiero Ong'ang'a and Kinya Munyirwa from OSIENALA in Kenya, for their support in Kisumu. Many thanks also to Mr Musyoki from the Coast Development Authority, Mombasa, for much help and encouragement. Many thanks are also due to Aussie Austin, Richard Holden, Dave Still and Stephen Nash from South Africa. The work in Maputaland was stimulating. Almaz Terrefe and Gunder Edstrom – thanks for the early enlightenment of eco-san – yours was indeed pioneering work in Ethiopia. Thanks also to Piers Cross and Andreas Knapp of the WSP-AF programme, Nairobi, for your interest and support of this work. From Mexico I thank Ron Sawyer, George Anna Clark and Paco Arroyo who have offered much advice and encouragement. I am most grateful to Xiao Jun from China for her valuable insights in pathogen studies. I also thank Jeff Conant, of the Hesperian Foundation, Berkley, California, USA, for introducing many of these eco-sanitation concepts into a new book – *A Community Guide to Environmental Health*. Uno Winblad is much thanked for his long experience and much advice. Many thanks to Paul Calvert for his valuable insights and enormous encouragement from India. Many thanks indeed to Arno Rosemarin and staff of SEI, Stockholm, who have supported the agricultural research side of this work as part of the new EcoSanRes research programme. Your support and encouragement in this venture is much appreciated. Many thanks also to Håkan Jönsson for valuable comments on an earlier version of this manuscript and together with Björn Vinnerås for important inputs and advice on urine use and the agricultural perspective. I offer sincere thanks and much gratitude to the late and much missed Steve Esrey from the USA, who was the greatest believer in eco-san and “closing the loop.” I am constantly indebted to Ingvar Andersson and Rolf Winberg for their long support and personal encouragement, which has meant much to me over so many productive years. I also offer thanks to Bengt Johansson and his staff at Sida for their support which has made so much work including this venture into ecological sanitation possible. Finally and most importantly, to my wife Linda, thanks for your patience, encouragement and every other possible support.

**Peter Morgan**

Harare

September 2004

# 1. An Introduction: understanding the concept of ecological sanitation

For most people sanitation means sitting on a toilet and flushing away the excreta to waste or simply sitting or squatting on a pit toilet and letting the waste matter build up in a pit. In both cases the excreta is disposed of and forgotten in the quickest and most convenient way. To be frank, this is an entirely logical view - there are far more important things to concern us all. But in a world which is becoming increasingly polluted from excreta, and where many of the world's population do not have access to a decent toilet at all, it does make sense to look at excreta in another way. The fact is that excreta can easily be made safe and contains valuable nutrients which can be used for enhancing the growth of food. And the methods of achieving this are not complex or expensive. On the contrary, they can be undertaken very cheaply, with great benefit to those who try.

Ecological Sanitation concerns the recycling of human excreta to form products which are useful in agriculture. Those who believe in ecological sanitation see the human excreta, not as a waste but as a valuable resource. And a resource which is renewed every day! To put it simply... *ecological sanitation is a system that makes use of human excreta and turns it into something useful, where the available nutrients can be recycled in agriculture to enhance food production, with minimal risk of pollution of the environment and with minimal threat to human health.*

In fact processed faeces can turn into excellent humus. This humus contains a well balanced mix of nutrients, such as nitrogen, phosphorus and potassium, which are easily taken up by plants. Urine also contains a similar range of nutrients, being particularly rich in nitrogen, which makes it useful for feeding green vegetables and maize. Even a combination of urine and faeces, when allowed to compost together in a shallow pit, with soil, wood ash and leaves, can turn into a sweet smelling and fertile humus. This humus is quite unlike the original matter from which it was formed, and when mixed with poor soil can greatly enhance vegetable production. Such a conversion is nothing short of a miracle of Nature.

But there are problems. Raw excreta is reviled, odorous and unpleasant in the extreme. The excreted products, particularly the faeces, are known to carry a multitude of pathogenic organisms which carry disease. For most people they are best disposed of and forgotten as quickly and as effortlessly as possible. That means the use of a flush toilet or a pit latrine - out of sight and out of mind. And for much of the world's population the flush toilet and the pit latrine must continue to form the basic form of excreta disposal for a long time to come.

But there is a growing concern about the use of ever depleting fresh water supplies to flush away such wastes, which can often lead to greater pollution "down the line." Where there is a lack of space, even the ubiquitous pit latrine cannot easily be emptied to form space for another. And even deep pit latrines eventually fill up and must be abandoned. The problems faced in high-density urban areas are the most pressing and also the hardest to solve. And for much of Africa, the cost of an improved latrine may also be prohibitive.

Perhaps the answer may lie in applying the principles of ecological sanitation. Now there is an extended range of options that can suit a wide range of users – from the very poor to those who are well off. Slowly but surely the concept of ecological sanitation is broadening and rising to help solve these serious problems.

There is also a concern that valuable nutrients are being lost, in vast quantities, every minute of the day by the disposal of excreta in conventional ways. The nutrients available in processed excreta are ideal for use on the lands and in vegetable gardens – and yet these valuable resources rarely come anywhere near our gardens in most parts of the world. Where flush systems are used they fertilise our lakes and seas instead of our fields, with dire consequences.

### **Shallow pit systems**

Two of the three main toilet systems described in this book process the excreta in shallow pits. The third system separates urine from faeces and these two products are processed separately. The methods using shallow pits are simple and relatively cheap to construct, and are thus more suited for uptake in the poorer countries of the world, where pit sanitation may already be the standard method of excreta disposal.

This approach has been undertaken for several reasons. The world of ecological sanitation has been broadened to include very simple and forgiving methods which are similar (if not identical) in their use to the standard pit latrine – the most commonly used excreta disposal system in the world. These systems have been given names – the *Arborloo* (a simple pit - toilet in which a tree is later planted) and the *Fossa alterna* (a twin pit toilet which forms humus). Such methods are, in this account, seen as introductory or entry points into the world of ecological sanitation and the recycling of human excreta. They are particularly useful and appropriate for use in parts of Southern and Eastern Africa. The urine diverting system is seen as an excellent but more sensitive concept – its success depending greatly on meticulous use and regular maintenance. Thus the range of options is expanded to include methods which are more forgiving and thus less sensitive to misuse. Also there is a problem of cost to consider. Urine diverting systems are more complex and costly to build and may be beyond the scope of the less well off, which on a continent like Africa, may be most. However, there are many ways of collecting the valuable urine other than separating it in a pedestal or squat plate. Urine can be collected in containers, bottles, potties and stored and later mixed with water for application to the soil. There is much flexibility.

### **Urine diversion**

There are many ways of putting ecological sanitation into practice – and it starts off with the use of an appropriate toilet. A huge range of ecological toilet designs exist from the very simplest to the most complex. Most ecological sanitation programmes throughout the world use a concept known as ‘urine diversion’ to separate the urine from the faeces. The faeces accumulate in one place and the urine in another. A specialised urine diverting pedestal or squat plate is used for this purpose. Most of these are designed for sitting, but an excellent squatting type has emerged from China. Both faeces and urine are much more easily handled when they are separated. The smell is much reduced, as is the potential for fly breeding, common to most pit latrines. The urine can be contained, and then later:

- a. Diluted with water to make a plant food particularly rich in nitrogen, or
- b. Applied undiluted to the soil and watered in, or
- c. Applied to the land without dilution, and then left, before planting, for soil bacteria to convert the urea into nitrate nitrogen for later uptake by plant roots.

In most urine diverting toilets, attempts are made to desiccate and sanitise the faeces. Lime or wood ash (and often dry soil or sawdust) are used for this purpose, being added regularly to the faeces which accumulate in vaults or containers. The combination of desiccated faeces



and ash or lime turns into an alkaline, sterile product which in countries like Guatemala is known as “abono.” This inert and inoffensive material can be stored in bags and is often applied to the land as a soil conditioner. Being very alkaline it is good for acid soils. When it contains much ash, this will help to increase the potassium level of the soil. In its dry state it is certainly quite a safe material.

Most practitioners of ecological sanitation feel the greatest value of excreta lies in the urine, which contains most of the nutrients, and a very high proportion of nitrogen. They see the dried faeces as a secondary product of much reduced value. Some advocate digging it into shallow pits or burning it. But this book promotes the view that humus derived from composted (as opposed to desiccated) human faeces is far too valuable to burn or to dig into holes which are then abandoned. In fact this humus has a far better overall balance of nitrogen, phosphorus and potassium than urine. Also the faeces, once processed, provides humus, a vital material for the healthy growth of all plants.

The ideal is to use a combination of both humus and urine in our gardens, taking advantage of the best qualities of each. Much has been written on the subject of urine diversion and reference should be made to the bibliography at the end of this book. This book deals mainly with the almost unknown range of non urine diverting methods, since they have been little researched and written about before. One chapter in this book is devoted to urine diversion and another to urine and its use.

### **Upgradeability**

The concept of being able to upgrade from one system to another is also embraced here. It is for instance possible to start in the simplest possible way with an *Arborloo*, and then upgrade to a *Fossa alterna*. This too can be upgraded later to achieve a fully urine diverting system, when the concepts of recycling are fully understood and appreciated. Thus urine diversion is a system to aim for in a step-by-step upgrading process. In all cases the primary aim of ecological sanitation is to recycle human excreta in a simple, safe and effective way. Whichever method is used, the results should be obvious to the users and useful to them. For without a true value being perceived from the user’s point of view, the ultimate aim of ecological sanitation can never be realised. To form a convincing appreciation, the humus formed in the eco-toilet must be seen to enhance the condition of the soil and actually lead to greater production of vegetables, food crops and trees. The urine must be seen to make plants grow larger and provide more food. Without such evidence, people will not be convinced.

The management of ecological toilets must also be simple enough to be achievable. The extra effort involved in managing eco-latrines must be repaid many times over in the end result – and in most cases this simply means more food to eat. Without this return, in the eyes of the user, ecological sanitation can never attain the position it deserves.

### **Recycling – the central issue**

Ecological sanitation embraces far more than building eco-toilets. The toilet is important but it is only part of the system. The toilet fits into a concept of recycling compostable materials within the homestead as a whole and plays its part in recycling biological wastes from the kitchen as well as the garden. Obviously the “eco-toilet” is a central component, but the system also includes the processing of human excreta into products which are safe and valuable in agriculture. The aim is to show that the nutrients held in processed human waste can be recycled in a simple, safe and effective way to increase the production of food (both vegetables and fruit). This is known as “**closing the loop.**” That means that food is

consumed, excreta formed, excreta converted into humus and that humus (and urine) is used to grow more food which is consumed again. That is closing the loop!

The **practical demonstration** of the usefulness of the by-products of human excreta in agriculture is seen as an important component of all ecological sanitation programmes. Consequently the crucial step of linking toilets with a method of producing humus or urine for use in agriculture (or forestry) must be emphasised. It is this very important management procedure which is vital to the success of ecological sanitation. In ecological sanitation, success depends on proper management, and thus depends on user participation to a far greater extent than conventional sanitation systems. It is no longer a case of sit and flush or squat and deposit. Ecological sanitation embraces a philosophy which the users must believe in and practice daily. Such an understanding and practice takes time to fulfil.

### **Forming links with agriculture**

Ecological sanitation has come at a most important time, not least because it is able, unlike most other forms of sanitation promoted before it, to form direct links with other important disciplines. The need to improve top-soils in a world where most soils are poor and unable to generate good crops is an important consideration. On a small scale, ecological sanitation can greatly assist this problem. The humus resulting from composted human faeces makes an excellent humus-like soil conditioner, admittedly not in huge quantities at the family level, but certainly sufficient to enhance vegetable production in the back yard. The aim is to mix the humus formed in toilets with infertile and worked-out soil, thus making a “new soil” in which plants can grow far better. The urine can also be used to enrich the soil further, particularly for growing green vegetables. Those practising ecological sanitation should also be familiar with the methods of making garden and leaf compost so that all these fertile materials can be mixed to form an enriched soil suitable for planting vegetables. Such humus, when properly used in agriculture, helps to improve food yields considerably and hence provides more food security and improves the nutritional status of the beneficiaries.

It is accepted that gardening and home based vegetable production may not be important to all potential users of ecological sanitation. But in the context in which this book has been written, which is for use in the urban, peri-urban and rural areas of Southern and Eastern Africa, food production in the home can be an important issue, and is taken seriously by most families. However, as we shall see, eco-toilets can solve other problems related to conventional sanitation, not least the saving of water or ease of excavation of shallow pits.

Thus important links can be made between sanitation and the worlds of agriculture and forestry. And also of importance is the link to permaculture where methods associated with the best organic farming are emphasised. Permaculture emphasises the use of natural methods, where organic materials of all types are used to make valuable humus. The miraculous change of human excreta into humus is one of Nature’s marvels. Without this natural process of “building up” and “breaking down” no animal or plant life could exist on Earth.

### **The living soil – humus is important.**

The message contained in this book sees the converted faeces as a product of considerable value and no less important than the urine. The soil is placed at centre stage as a converter of excreta into humus. The ideal is a mix of excreta, soil, ash and leaves, which, within a year turns into a valuable humus within a shallow pit. Even with urine diversion, the separated faeces, initially mixed with some wood ash and soil in the latrine, can be moved to a

“secondary composting site” where additional soil and leaves are added. The end result is also a nutrient-rich humus, not a sterile dust. The converter is the “living soil,” greatly assisted by the presence of leaves and ash.

### **Global considerations**

Perhaps there are broader objectives too. Turning a renewable waste product like excreta into humus in which plants of all types can thrive has considerable merit in its own right. Even more so, in a world overlain by depleted soils and barren landscapes. Saving valuable phosphorus, a vital nutrient in plant formation, is also vital – for world supplies are being depleted at an alarming rate. Human excreta is a most valuable source of phosphorus, and also of nitrogen and potassium – all vital elements to food production.

Letting Nature work so effectively for Man has supreme merit. *Nature at work* lies at the heart of the message provided by this book. The conversions are natural - the growth of plants a natural response to the fertile soil. The soil organisms of all types, beneficial bacteria, fungi, worms and insects, are seen to be at work throughout the entire process. The nutrients available in eco-humus and urine can work for the benefit of Man. Whilst these processes of Nature take place, for the most part out of sight and out of mind, in combination they represent a great movement towards improving the fertility of the Land - something of supreme importance for the survival of Mankind on a planet which is fast being depleted of its natural resources.



**Fine tomatoes growing on humus derived from excreta**

## 2. The answer lies in the soil

The theme which is central to this book about ecological sanitation is its link to the soil. Soil with its complex makeup of living organisms and nutrients is essential for the formation of humus. Even the recycling of urine is linked to the soil, for soil bacteria are essential for the conversion of urea and ammonia contained in urine to the nitrate - a salt of nitrogen which can easily be taken up by plants. When a mix of soil and excreta are combined, the organisms in the soil help to break down the excreta to form humus. The excreta in return offers additional nutrients to the soil and also improves the soil's texture. Adding urine increases the nutrient content further. So the living soil is central to the process.

The various toilet systems and recycling methods described in this book have been so designed that the excreta which accumulates is converted into humus in a form which can readily be used by a great variety of plants – whether they be vegetables, cereal crops, flowers or trees. In the case of the *Arborloo*, a shallow pit toilet where a tree is later planted in the composting pit contents, humus formation is encouraged by the regular addition, not only of excreta but also of soil, wood ash and leaves into the pit. Once the pit is almost full, the structure and slab are removed and placed on top of another shallow pit nearby. The used pit is topped up with a generous layer of leaves and more fertile soil and a young tree is planted in this soil, watered and protected. It is planted in the soil – not the excreta – plants do not survive when planted in fresh excreta. If the fates are kind, the young tree grows, at first in the topsoil, whilst the excreta below is being transformed into humus as it would in Nature. In this way the nutrients held within the pit contents are utilised by the growing tree, and when the tree matures, can be recycled to produce fruit (fuel or building materials). Much of the urine is absorbed into the mass of humus or leaves held within the pit, and the excess will be drawn into the surrounding soil and converted into usable nutrients – which the tree can also use later in its life. The *Arborloo* thus travels on a “never ending journey” through the “lands” followed by a series of trees which may eventually form a woodlot or an orchard – or just simply shade or ornamental trees scattered here and there. Sometimes a young tree will hesitate as it starts to grow. A few may die, but most grow strongly right from the start if well cared for.



The *Arborloo* is the simplest ecological toilet. Photo at Eco-Ed Trust.

In the case of the *Fossa alterna*, the second simple eco-toilet described in this book, a similar process takes place in the shallow pit, with soil, wood ash and leaves being added as well as excreta. The difference is that the *Fossa alterna* is built with two permanently sited shallow

pits which are used alternately. Both pits can be housed within a single more permanent structure or a portable structure can be built and moved from one pit to the other at yearly intervals. Once the first pit is nearly full, the structure is moved to the second pit which then begins to fill. The first pit is topped up with a good layer of leaves and topsoil. After one year the contents of the first pit will have changed their form into humus which can then be dug out and used on the garden. The structure is then moved back on to the emptied pit. It moves from one pit to the other once a year, every year – a process which is fully described in this book.



**A Fossa alterna in Epworth, Zimbabwe. The twin pit system makes humus**

In the case of urine diverting toilets where the urine and faeces are separated, the faeces normally accumulate in one of two vaults beneath the pedestal and the urine collects in an offset plastic container. There are many descriptions of urine diverting toilets in the international literature (see bibliography at the end of this book, notably *Ecological Sanitation* by Esrey et al. 1998 – a revised edition of this book will be available in 2004).

In the example described in this book, the faeces accumulate together with soil and wood ash in a **bucket** held within a small **single vault**. The soil and wood ash are added after every visit made to deposit excreta. This mix of faeces, toilet paper, soil and wood ash is removed within the bucket and deposited into a “**secondary composting site**” where more soil is added. This site can be a container, such as a cement jar or twin shallow pits etc. Here the composting process continues and the mixture changes its form into humus for onward passage to the garden at a later date. The writer has called this system the “*Skyloo*.”

Human faeces readily turn into humus if they are in close contact with a fertile soil – and are kept moist and are well drained and aerated. The aim is to allow the soil to form layers within the accumulation of faeces to effect the change. The mix of faeces, soil, ash and paper, once removed from the toilet in the bucket, and added to the shallow pits, trenches or containers and covered with layers of fertile soil changes quite quickly from a most obnoxious, foul smelling mass into a pleasant humus. This is quite remarkable. It takes place in nature all the time, on the forest or woodland floor, for instance, where the “wastes” produced by animals turn into humus on the rich organic forest floor together with leaf compost formed from the fallen leaves. All the nutrients formed are recycled back into the forest floor and then back into the soil and taken up by the trees again. That is Nature’s way.



## The importance of humus

Humus is the dark crumbly material formed from decayed matter formed in Nature from a constant supply of residues from both animal and plant life. These residues are constantly converted in Nature by the organisms present in the soil and also in the residues themselves. Moisture is required during the whole period during which the humus is being formed and also abundant aeration is essential. The presence of leaves will help to improve aeration. Even in Nature, if too much water is present, the aeration of the forming humus is impeded and the process slows down or stops. If too little water is present, the activity of the micro organisms slows down and then may cease altogether if the mass becomes desiccated. Desiccated leaves can remain unchanged for decades or even centuries – but when they are moistened they decompose readily. Rainfall is an excellent method of watering since it is a saturated solution of oxygen. The conversion of the various natural products into humus is a result of activity by beneficial bacteria and fungi and also by a myriad of other micro organisms and small animals and insects. Bacteria are essential to this process. Most bacteria present in Nature are beneficial to life and present no health threat. In fact by far the majority of bacteria are essential to the natural process of breakdown. Without this process of breakdown, followed by re-growth, life on this planet could not exist. The soil is the home of millions of beneficial bacteria.

Humus is essential to soil fertility and adds an important physical condition to the soil, making it more crumbly, more moisture retaining and physically capable of greater oxidation, which is essential for the growth of all living organisms including plants. In ecological sanitation, the best humus is derived by mixing the soil formed from excreta with other humus like soils and leaf compost. Thus excellent humus can be built up, in a series of generations, by adding and mixing. The earth worm, the bacteria, the fungi, and a myriad of other micro-organisms of a benevolent character whose habitat is the soil are important actors in this process. The only way to farm or to manage a successful garden is to maintain the fertility of the land by adding humus – thereby preserving the living content of the soil. That living content of the soil is best maintained by the constant refreshment of further supplies of life in the form of humus. Everything we see in Nature shows the greatest use of every type of “waste.” In fact nothing anywhere in Nature is allowed to go to waste. Recycling is a central theme in Nature. Ecological sanitation also promotes this ideal.

These views, well expressed by Friend Sykes in his book *“Humus and the Farmer”* and other promoters of the humus theory (Howard, 1943 and Balfour, 1943) make a lot of sense (see bibliography). Others promote the use of chemical fertilisers as the best means of obtaining adequate crop yields on the land. The probable truth lies somewhere in between, in striking a balance between using natural and artificial fertilisation (Hopkins (1945). This wise concept is also discussed by Louis Bromfield in his book *“Malabar Farm”*. In his studies of the land, Bromfield found that chemical fertilisers were of very little use on soils devoid of organic material and of great immediate value upon soils high in organic content. Studies revealed in this book also show that the same holds true for the application of urine to the soil. Urine adds only chemical nutrients to the soil and no living material or humus. Bacteria in the soil are essential for the conversion of the urea present in urine into forms of nitrogen (nitrate) which can easily be absorbed by plants. So the use of urine as a plant food, depends very much on the soil and its living content to be effective. Soil containing humus is far more effective at processing urine than soil deficient in humus, such as very sandy soil. So once again, the soil plays a central role, even in the use of urine.

The capacity of chemicals to burn out crops or to destroy bacteria, earthworms and other living organisms in the soil, Bromfield found, was largely determined by the amount of

organic material present and of the moisture content which accompanies its presence in the soil. Nothing was so effective in trapping and holding rainfall and moisture as organic materials in every stage of decay. Thus it would appear that the value of humus holds true, whether or not artificial fertilisers are added, in whatever form they are used. This must also hold true even where diluted urine is the source of liquid feed. Plants will respond better to urine if the soil is more humus-like and has water-holding properties. Thus the recycling of both solids and the liquids of human excreta must depend on the presence of humus - the living soil.

One major difference between the process taking place in the garden compost heap and that seen in our shallow pit eco-toilets or the production of humus from excreta in bags, buckets and jars, is the relatively larger proportion of “manure” (human faeces) and the smaller proportion of vegetable matter. Vegetable matter in abundance is vital to the “Indore Process” of composting promoted by Sir Albert Howard. With less vegetable matter being present in the humus formed in shallow pits and jars containing human excreta, there is little rise of temperature – as compared to the compost heap where significant rises of temperature occur. The conversion of excreta into humus in this case does not depend on the activity of heat loving (thermophilic) micro-organisms (bacteria and fungi) but rather those bacteria and fungi which thrive at ambient temperature (mesophilic), that is close to the temperature of the surroundings. All manner of other beneficial organisms, including insects, worms, and many other life forms also thrive best at ambient temperatures. Not only do these animalcules and microbes digest the excreta but also inhibit, compete with, consume or otherwise antagonise those pathogenic organisms, such as bacteria that carry disease. The process is an entirely natural one leading to the formation of humus. The addition of fertile soils and leaves to excreta also help to absorb much of the moisture content of the excreta itself – a process which is associated with a reduction of the volume of the mass. The end result of this process is a crumbly, darkened humus, which when mixed with topsoil makes an excellent soil conditioner and nutrient enhancer.

The conversion of raw excreta into humus, in the presence of adequate volumes of soil, leaves and ash, reveals a change of colour, odour and texture of the original faecal matter, which darkens, becomes pleasant to smell and handle and also become more friable. The activity of insects and their larvae may also be important in breaking up the faeces as well as bacteria, fungi and earthworms where they are present. Roots from trees and other plants also invade the highly organic layers in the eco-pits or containers where excreta is converting, and are very visible when the pit is being excavated or the jar is opened. Where plants grow into the organic materials held in pits or containers, their roots also convey oxygen into the body of the material, which greatly assists the decomposition process. In Nature, all living organisms and their products eventually end up in the soil and become part of it, only to be recycled again and again within a never ending process of building up and breaking down.

The top-soils of many parts of Southern Africa are worn out and almost devoid of humus or nutrients. In Zimbabwe 70% of rural farmers work on a soil which is labelled as poor or very poor, and unable to sustain a good crop without the use of manure or fertiliser. Nitrogen is being lost at a greater rate than it is supplied. Even when nitrogen is applied, heavy rain can leach out the nitrogen and drive it down to deeper layers where it is not available to plants. Most naturally occurring soils where people live are not only deficient in nitrogen but also in phosphorus and potassium and also many trace elements. Nitrogen, phosphorus and zinc, amongst other minerals are seen as limiting to meaningful agriculture in 70% of samples collected around Zimbabwe. Most soils are sandy and have a low pH. Few soils in the rural and even peri-urban and urban areas can sustain any form of healthy crop production without meaningful inputs of both humus and nutrients. These issues are discussed in

“Ecoagriculture: Initiatives in Eastern and Southern Africa”, edited by Devlin and Zettel, 1999 (see bibliography).

Since the soils of Africa are so depleted in nutrients there is an overwhelming case for using all methods available to restore both nutrients and fertility. The use of animal manure is widely used in those areas where cattle are kept and this technique forms part of a longstanding traditional practice. But huge numbers of people, particularly those living in the peri-urban fringes do not own cattle. In a world where commercial fertilisers are becoming increasingly unaffordable, there is an even greater need to harness any other form of humus or nutrient suitable for crop growth. It is in this context that processed human excreta must be considered. Whilst the volume of excreta produced by a family is not large, it is certainly enough, once processed, to contribute significantly to the fertility of a family vegetable garden and that should be the initial aim. This means taking full advantage of whatever humus can be processed, including leaf and garden compost and also urine and combining their best properties to increase the food crop.

The successful use of the specialised toilets used in eco-san depends to a large extent on the users’ understanding of the processes involved, and the potential benefits to be gained. Compared to pit latrines, which can provide an almost maintenance free service for a decade, ecological toilets require more attention and the advantages may not be immediately obvious.

A tree planted in an *Arborloo* pit may take a few years to bear fruit. Two years are required before the first humus can be dug out and used from the *Fossa alterna* pit. Thus sound educational programmes and novel forms of demonstration must therefore precede programmes of construction – with ample evidence of the benefits to be gained. Most people simply do not believe that excreta can turn into “soil.” And this “soil” together with their own urine can save them money that would otherwise have been spent on buying fertiliser. One needs evidence to believe and that means individuals seeing the proof with their own eyes. **Seeing is believing!**



**Group of eco-san trainees at Kufunda Village, Ruwa, Zimbabwe, planting a mulberry tree on an *Arborloo* pit (mid 2002). The same mulberry tree (on the right) has grown. Banana trees too. The *Arborloo* is in the background. Photo taken early 2004.**



### **3. Modifications of the pit toilet**

Man's most commonly used toilet, the pit latrine, has been used in some form, on most continents for thousands of years. This concept continues to be the simplest, cheapest and most favoured method of excreta disposal for most of Africa, not counting the towns and cities. But even in the towns and cities, pit toilets are used a great deal. Their relative cheapness, ease of construction and ease of use make them popular. Problems of odour and fly breeding can be largely overcome by fitting a screened vent pipe, or by adding respectable amounts of soil and ash to the pit. Indeed a properly made pit toilet can be as comfortable to use as the best of other conveniences, although of course it must be built outside and very close to ground level. For these various reasons more people use pit toilets than any other form of excreta disposal, world wide.

The pits under most pit toilets are invariably dug about 3 metres deep, although in Kenya they may go much deeper. Most times, pits fill with a mix of excreta and garbage – the pit toilet is a convenient dustbin! Some pits are lined, others not. Most pits are covered with a slab made of wood or concrete, and the house above, made in a thousand different ways, provides privacy. The worst pit toilets are a menace, generating foul odours of the worst possible type and breeding flies in alarming numbers. Those in high water table areas in the denser settlements can also pollute underground water, and wells polluted in such places can carry disease. However, well constructed pit toilets can be a pleasure and comfort to use. They can be odourless and fly free. Well sited, they are not a threat to health in any way. By far the best are those built and used by a family, where they are generally kept clean and tidy. The vast majority of pit toilets are used until their vaults are full, and then they are abandoned, and new facilities built.

But in some countries and some communities, the value of the pit contents as a fertiliser has long been known. In several countries in Africa, and indeed elsewhere, trees are deliberately planted on old toilet pits because they are known to grow well, with the fruits growing large and tasty. Sometimes nature sows a seed in an old pit and a new tree will grow. Sometimes tomatoes or pumpkins will grow out of abandoned toilet pits, no doubt because kitchen scraps have been thrown there. There are some cases where the contents of old pit toilets, after a period of a few years, are deliberately dug out and used as fertiliser on the lands. So in these rather more isolated cases, the usefulness of the pit toilet extends far beyond its normal life. This book attempts to extend the logic of this concept and make it better known and understood. The usefulness of the pit toilet can indeed be extended far beyond its normal working life.

#### **Some basic concepts about pit toilets**

Once faeces and urine enter a pit, a process of breakdown begins. The end result is humus. If the pit is filled with excreta and garbage alone, the composting process can take many years to complete, since there is little air in the compacted excreta and few suitable microbes. If the excreta is mixed with other materials like soil, wood ash and leaves, more air is introduced into the mix and also a complexity of microbes which are able to change the excreta into humus more efficiently. The end result is that the composting process is much accelerated. Also excreta filling unlined, earth walled pits composts more quickly than pits lined with bricks or concrete. This shows the important effect the soil and its living content has on composting excreta.

Another interesting aspect is the depth of the pit. In deep pits the contents become more compact, and once again contain less air. In shallower pits, which are less compact, there will be more air, particularly if there is a mix of ingredients. This is particularly so if leaves are added to the mix in addition to soil. Leaves help to reduce the density of the final humus and therefore increase the air content, which in turn makes composting more efficient. Shallow pits are also easier to dig out and further away from the underground water table. The eco-toilets described in this book use shallow pits which are rarely more than 1.5 metres deep.

However, shallow pits do fill up more quickly than deeper ones and it is necessary to strike a balance. If a mix of ingredients is added, the pits will certainly fill up faster, but not as fast as one would think, as much of the bulk of excreta is in liquid form which is partly absorbed by the soil and ash thrown down the pit, and partly leaches away into the surrounding soil. At least 70% of human faeces is made up of water, and when mixed with soil, the volume of composted faeces is much reduced. Actively composting excreta significantly reduces in volume over time. So a balance must be struck and a choice made. Deeper longer lasting pits need less attention, but eventually fill up and are usually abandoned. Shallower pits holding a mix of composting ingredients fill up more quickly, but the resulting humus can more easily be dug out, and used for growing vegetables or for growing trees.

The processes involved are simple and natural, and if care is taken the composted humus is considerably safer than hands soiled after anal cleansing. The increase in food production can be considerable, as this book reveals. This process adds a new interesting dimension to the rather dull story of building toilets. The worlds of sanitation and agriculture are now combined with a definite benefit being gained by the family in addition to the disposal of excreta alone. Food production can be enhanced. Also the eco-toilets, as they are best called, are relatively cheap and easy to make. With a little training it can all be done by the homesteaders themselves.

In this book we look at ways of building and managing the various simple eco-toilets designs. Then the important subject of using the recycled materials in agriculture is discussed and explained in detail with many working examples described.



Simple eco-toilets in Malawi. On the left an *Arborloo*, on the right a *Fossa alterna*

## 4. How to build and manage the *Arborloo*

The *Arborloo* is a nothing more or less than a simple pit latrine. But it differs in several fundamental ways in its design and the way it is used from the commonly used deep pit latrine.

\*All the parts of the *Arborloo*, apart from the pit, are portable. This includes the “ring beam” protecting the pit head, the concrete slab and the superstructure. Each of these components moves on a “*never ending journey*” from one pit to the next at about 6 -12 monthly intervals. The latrine is literally picked up and moved, leaving the almost filled pit behind.

\* *Arborloo* pits are shallow, - normally no more than one metre deep and they are not lined with bricks or other materials. The pit is normally protected at the head with a “ring beam” made of bricks or concrete which strengthens the pit head and reduces the effects of erosion and pit flooding from rainwater. In very sandy soils, a 200 litre drum may be used to make a pit lining. If the soil is very firm, no ring beam is required at all from a constructional viewpoint, but it helps to raise the toilet foundations on a ring beam to stop pit flooding during the rains.

\*Soil, wood ash and leaves are added regularly to the pit in addition to excreta. These aid the composting process considerably. The remarkable conversion from excreta into humus is normally complete well within 12 months of closing off the pit. The addition of soil and ash on a regular basis also reduce fly and odour nuisance.

\* The *Arborloo* pit is NOT used as a dumping ground for rubbish like most pit latrines. The dumping of plastic, bottles and rags etc, is not recommended.



An *Arborloo* in Phalombe, Malawi

\* Once the latrine has been moved to the new site, a layer of leaves and fertile topsoil between 15cm and 30cm deep is added to the contents of the pit, which are first levelled off. The pit contents can be left for a month or two or more to settle or can be planted with a young tree straight away. Some people prefer to leave the day of tree planting until after the arrival of the rains. This is a wise move if water is scarce. But it is also possible to plant the young tree directly after topping up with soil. Trees will not grow in raw excreta - they must be planted in a good layer of soil placed above the excreta. Within a few months the layers containing the excreta will have changed into humus which the tree roots can then start to invade. So in effect the old latrine site becomes a site for a tree. Most trees will grow well in these shallow

pits if planted properly and cared for. The young tree should be watered regularly, and protected from animals like goats and chickens like any other young tree. Covering the surrounding soil with “mulch” helps to retain water. With a combination of excreta, soil, ash and leaves in the pit the pit contents turn into humus which most tree roots can cope with easily and later will thrive on. Later on diluted urine can be used to provide additional nutrients.

The *Arborloo* fulfils all the basic requirements of ecological sanitation. The recycling of human excreta is made as simple and convenient as possible. Natural processes are involved in a way that retains a simplicity of method and flexibility of design. The latrine is safe from a health point of view - the excreta is never touched by hand and contained below a layer of leaves and topsoil. Thus contamination of the environment is minimal. The pit is shallow and thus further away from ground water than any conventional pit latrine. The excreta (faeces and urine) combine with the soil and other ingredients to form a crumbly, nutrient rich humus, which becomes an ideal medium for tree growth. Thus the odorous and potentially dangerous raw excreta are converted far more quickly into a safer humus than in “deep pit” latrines. The combination of human excreta and soil, ash, leaves etc greatly enhances the nutrient levels found in the parent soil. This applies to all soils - whether they are rich or poor. The humus formed is crumbly, with much elevated levels of all the major nutrients like nitrogen, phosphorus and potassium, which the trees can use. The ability of the “new soil” to retain water is also enhanced. Urine added to the pit is either absorbed into the pit humus or leaves or soaks into the side walls and base of the pit where some of its nutrients (particularly phosphorus) become available later, when the tree roots penetrate the soil. As the tree grows it absorbs more and more of the nutrients laid down earlier. Over time some nitrogen is lost, but this can be applied later with diluted urine.

The *Arborloo* also provides an excellent example of how the nutrients derived from human excreta can be recycled through the production of food - in this case fruit. The concept of “closing the loop.” is well demonstrated. The fruits eaten from trees grown on older *Arborloo* pits, once processed by the human body, are reintroduced back into the *Arborloo* pit currently being filled. Over a period of time “woodlots” of gum trees or “orchards” of fruit trees will result and the general fertility of the land is improved. Trees also offer shade, leaf compost and stability to the soil.

Remarkably, the mixing of barren topsoil and human excreta, results in a mix with enhanced nutrient value. If a fertile soil and leaves are also added, the resulting mix is even richer. It is into these soils that the tree roots will eventually grow. Tree growth into the pit contents represents only the first stage of root invasion - it continues into the surrounding soil which will also be nutrient enriched to a lesser extent.

Not surprisingly, a similar method of processing human excreta, has been used in the African traditional way of life for generations. In countries like Malawi, Mozambique, Kenya and Rwanda, villagers traditionally plant trees on disused latrine pits. And even nature uses the same principle - often the seeds of trees fall into disused and abandoned pits and germinate there. What better means exist to show that even human excreta, once changed into humus, can be an ideal medium for tree growth. The *Arborloo* is a refinement of this simple and well established principle. The physical structure of the latrine is designed to be portable, unlike more conventional latrines. Also the shallow pit is fed a mix of ingredients, deliberately, to ensure a more rapid conversion of excreta into humus and thus a better survival and growth rate of trees.

In practice the latrine is used until the pit is nearly full, which for a family should be between 6 and 12 months. Once the pit is nearly full, the structure, slab and ring beam are removed and the ring beam is placed on another suitable site nearby and a new pit dug within the beam - about one metre deep. The slab and superstructure are now placed on top of the beam and the latrine is put to use once again. The family may start off by using the toilet in any convenient place, but may then decide to place it within a specific piece of land set aside for an orchard or wood lot. Gum trees grow particularly well on these organic pits. However fruit trees are generally far more popular. In Malawi, citrus trees like orange and tangerine are the most popular trees because they have a commercial value.

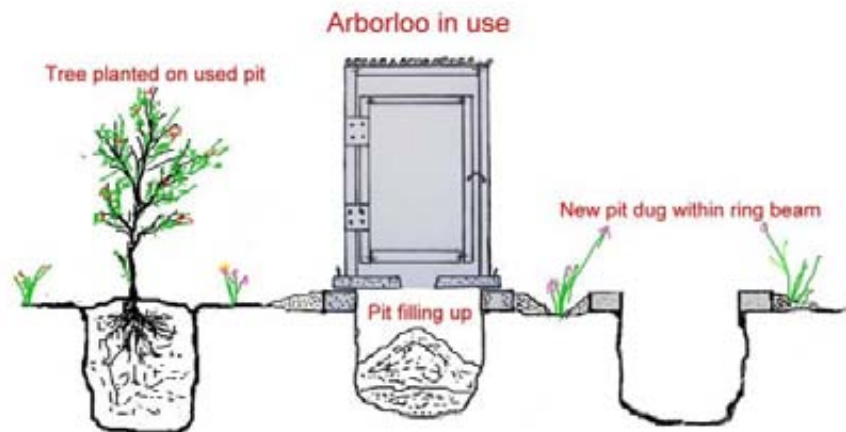

The *Arborloo* moves on a never ending journey leaving behind a series of fertile pits filled with a mix of human excreta, soil, wood ash and leaves etc which provide a suitable planting medium for trees when composted. Nutrients in the excreta are used by the tree to enhance its growth.

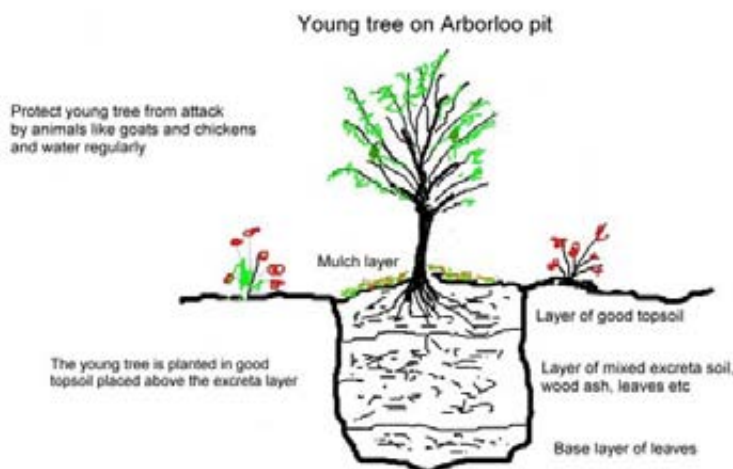

## HOW THE *ARBORLOO* WORKS

In time all human excreta or animal dung turns into soil. The rate of conversion depends on many factors such as temperature, the proximity of soil, containing the myriad of micro-fauna and micro-organisms, including bacteria and fungi that break down excreta. Also the presence of air and moisture is important. Animals like worms and insects also play their part in “breaking down” and converting the excreta. The addition of leaves and other organic vegetable matter also assists the process by increasing the proportion of air in the compost, and also improves the final fertility and nutrient level of the humus. In contrast, the process in deeper pit latrines, to which only excreta is added is quite different. Here the solid mass of excreta from top to bottom, can lead to anaerobic conditions which really slow down the process of conversion considerably. Such a conversion may take several years to complete. The rate of conversion in deeper pits will depend on several local conditions such as whether the pit is lined or not and the depth etc. Compost formation is faster in unlined pits since the area of living soil in contact with the excreta is large compared to those pits which are lined with bricks or concrete rings.

Thus a shallow, unlined pit, filled with a mix of ingredients certainly hastens the conversion process, but it also hastens the filling of the pit! Thus a balance must be struck. In fact when dry soil and ash are added much of urine and water content of the faeces are absorbed into the soil and the increase of volume is not as great as might at first be feared. In fact nearly 70 - 80% of the faeces is made up of water, leaving only about 20% solid matter. It is this 20% which is finally absorbed into the humus like material formed.

Whilst moist conditions are important within the pit, the pit should not be flooded with water, as this destroys the ideal environment of conversion and also increases the risk of spreading pathogens from the pit. Also the contents should not be so compacted as to exclude air, which leads to inefficient anaerobic conditions being encouraged. Thus it is essential for the process to take place at its best, that a good deal of soil, ash and leaves are added regularly to the pit. Under these conditions the effective aerobic conversion of excreta into a humus-like soil can take place quite efficiently. Just a few months may be all that is required. Within a year, the humus is fully formed and relatively safe. In the *Arborloo* it will never be touched.

### **Siting the *Arborloo***

It is normally recommended that standard pit latrines are built at least 30m away from water sources such as wells and boreholes to avoid potential contamination of the water source. This is an arbitrary figure as the potential of the pit latrine as a source of contamination of ground water depends on many factors such as soil type, water table depth, potential for flooding, slope, season, etc. Very often the potential of pit latrines as a source of contamination for shallow water supplies has been exaggerated, but there is still much debate about it (see bibliography). Where there is space, such as in the rural areas, pit latrines can be placed well away from wells as a matter of routine. This may not be the case in peri-urban situations where plots sizes are much smaller (see bibliography). However where shallow composting pit toilets like the *Arborloo* (and *Fossa alterna*) are used, there may be more flexibility on siting in relation to water sources.

The site chosen for the latrine should fulfil several other requirements. It should be convenient for the users. It should also be placed on slightly raised ground to avoid flooding during the rains. It should also be sited some distance (about 30m) away from any well used for domestic purposes. In the case of the *Arborloo*, the fact that a tree will be growing there in years to

come should also be taken into consideration. Thus thought should be given to the possibility that in many years to come there may be a lot of trees growing on old pit sites which will form an orchard or wood lot. Trees do require space!

In siting the *Arborloo*, consideration must also be given to the future site of individual trees, orchards, wood lots or plantations. Thus the family must decide where the future trees may be planted in relation to their homes and the gardens. For instance trees may be planted in special places within the garden which may provide shade or fruit, or they may be planted in an orchard (for fruit trees) in a specific area. They may also be planted along a fence line. The spacing may depend on the type of tree to be planted. For trees which grow large like the mango or avocado, planting sites should be placed several metres apart to allow healthy growth of the mature trees in the future. However in the case of paw paws or gum, for instance, the pits may be closer together. Paw paw wood is soft and can easily be trimmed and the tree life is more limited. After some years, a paw paw could easily be removed and the same pit site dug out and used again. This may make the paw paw more suitable for smaller plots in peri-urban or urban areas. Also pits can be planted along fences where trees may also be grown.

### **Ground water protection**

The reduced depth of pits used with the *Arborloo* increases the distance between the raw excreta introduced into the ground and the local water table. However the reduced potential for ground water pollution is not related to pit depth alone. The contents of *Arborloo* pits also differ from standard pits in that they contain a mix of excreta, soil, ash, leaves etc which promotes an aerobic composting process in which the raw excreta is converted into a soil like humus much more rapidly than in deeper conventional pits. This earthy humus is quite unlike the original pit contents and its potential for contaminating the ground is likely to be much reduced compared to the almost raw excreta contained for years on most deeper pits.

These conditions include the existence of soil micro-organisms and air which the additions of soil and ash/leaves etc help to form. The process is different in the standard deep pit in which the pit contents of human excreta and anal cleansing materials are much more compact, exclude air and contain very few soil micro-organisms and where the process of conversion is normally of the anaerobic type which is far less efficient than the aerobic type promoted in the *Arborloo*. The addition of soil, wood ash and leaves for instance, in volumes which are about equal to the excreta is vital for this process. The resulting humus, far from polluting the ground, actually enhances the fertility of the soil and allows for increased biological activity which promotes the growth of plants and trees in particular in the *Arborloo*. However it is best to avoid areas which are subject to flooding, as the ground water may penetrate the pit and upset this natural composting process and spread pathogens before they have been destroyed. In such cases “above the ground” methods must be sought (see later).

### **Ground stability**

The ring beam method of protecting a shallow pit may require some experimentation in some areas at first. In firmer ground the beam will remain very stable, but in looser and sandy soils more care should be taken. If an *Arborloo* pit shows any signs of collapsing - the ring beam, slab and structure can be removed within a few minutes and relocated elsewhere. In some places the soil is so firm that even a ring beam may not be required, especially where the *Arborloo* method is chosen. But even in this case, the possibility of pit flooding should be avoided with the use of a ring beam. Currently the ring beam is being tested in a wide variety of environments in Zimbabwe, from very sandy soils to firmer red soils.



## The *Arborloo* - Stages of construction

Now we shall describe how to build and manage the simplest eco-toilet – the *Arborloo*. The basic building components of both the *Arborloo* and *Fossa alterna* are the same, but the *Arborloo* is built with a single shallow pit about one metre deep in a temporary location. The *Fossa alterna* is built with two shallow pits which are deeper (1.2 – 1.5m deep), wider and permanently located. Generally *Arborloo* slabs and pits are made round to suit a more traditional type of structure, and *Fossa alterna* slabs and pits are made rectangular. But in fact whilst the building components of both these eco-toilets are basically the same, there is much variation in the way they are built. There are four basic components:

1. The shallow pit or pits
2. The component protecting the shallow pit (concrete or brick ring beam or brick lining)
3. The concrete slab
4. The “house” (superstructure).

To this can be added additional components like pedestals, vent pipes or hand washing facilities, which are optional additions. Low cost pedestals can be made very attractive by using standard plastic toilet seats in combination with a off-the-shelf 20 litre buckets. The method is described later in this book. Vent pipes (PVC or asbestos) help to ventilate the pit, providing a throughput of fresh air as well as removing odours from the toilet. Vents also remove excess moisture and condensation from the pit and composting materials. Hand washing devices attached to the toilet are essential if personal hygiene is to be improved.

### Which slab and ring beam?

The *Arborloo* is normally made with a small round concrete slab and matching ring beam made of bricks or concrete. But there is much variation in the size and shape. Slabs and ring beams for the *Arborloo* can also be made rectangular (see chapter on *Fossa alterna*). If a rectangular portable superstructure is to be used, the rectangular shape is preferred. If traditional poles and grass are to be used, the round shape may be better. Each has its advantages and disadvantages. Round slabs can be moved by rolling them, which can be a big advantage. This means that for the one metre diameter slab (and matching ring beam) a single person is able to move the slab and ring beam to the intended toilet site. Rectangular slabs and rings beams cannot be rolled so they need at least two people, and normally four persons to lift and move them. But rectangular pits are easier to dig and excavate than round pits. The pit linked to the one metre diameter slab is about 80cm wide, and this is not so easy to dig and re-excavate compared to the rectangular pit which provides more room for using the digging tools, and in the case of excavation, also for repeated excavation.

There are advantages in using a rectangular slab together with a rectangular movable superstructure. The superstructure just sits on top of the slab. The structure need never touch the surrounding soil and this can have its advantages. If part of the structure is made of timber, the termites are less likely to eat the wood if it is sitting on a concrete slab compared to being part dug in the ground. With round slabs, the structure is normally built around and outside the slab. This means that the soil must be raised around the slab. Generally round slabs are best for simple structures made from poles and grass.

Then there is a question of economy. A high strength round slab made with cement and river sand can be made one metre in diameter using ¼ bag of cement (10 litres) and 30 litres river



sand (1:3) and 3 - 4mm reinforcing wire. This is a very strong and relatively light weight slab. It can be moved after 7 days of curing. The same size slab can be made with a mix of 5 litres cement (1/8<sup>th</sup> bag) and 30 litres river sand (1:6) and 3 – 4mm reinforcing wire. But in this case the cement and sand must be of the highest quality and great care must be taken at every stage of construction. 10 days of curing is required for this “economy slab.” If care is not taken the economy slab will crack. If care is taken, it is as good as the high strength slab. The larger 1.2 metre diameter round slab can also be made also with 10 litres of cement and 50 litres river sand (1:5) and 3 – 4mm reinforcing wire. A 1.2m X 0.9m rectangular slab can also be made with the same mix of ingredients (see later). 8 litres of cement is provided in the “Compost Toilet Starter Kit” and is mixed with 30 litres river sand to make a 1metre diameter slab (see later).

The concrete ring beams linked to these various concrete slabs are made with the same mix of materials (cement, river sand and wire) as the matching slabs. All these alternatives are described in this book.

The ring beam is valuable since it helps to stabilise the head of the pit. In very loose sandy soil a ring beam may be inadequate, but in most places it works well. To lower costs ring beams can be made of local bricks. These can be mortared together with weak sand and cement for the *Arborloo* since they will be moved every 6 – 12 months. Termite mortar or clay can also be used to mortar the bricks together. Where the ring beam is made for the *Fossa alterna*, it will remain in position for long periods of time. So if it is made of bricks it is best mortared together with strong cement mortar. A concrete ring beam is ideal for the *Fossa alterna*. If the soil is very loose and a *Fossa alterna* is chosen, then the shallow pit (dug down 1.2 – 1.5m) should be brick lined to the base.

### **Upgradeability**

Since this concept of making humus in shallow pits for growing trees and vegetables is still evolving, there is still room for various ways of doing things. A family may decide to start by building an *Arborloo* using a one metre diameter slab and bricks as a ring beam. This slab may use a quarter bag of cement (or even an eighth of a bag with care for the economy model). Then the family may decide to make a concrete ring beam later. If well made, the concrete work will last almost indefinitely – it is just moved from one location to the next – there is no need to reconstruct it every time the toilet moves – and this can be an advantage. Then, later on, the family may choose to use the pit humus for use in the vegetable garden rather than grow trees. In this case the family can make two extra ring beams of bricks or concrete and rotate the toilet around the three permanent toilet sites and excavate the humus after one year of composting. Even the toilet which uses one slab and three rings beams will use only a single 50 kg bag of cement for the high strength concrete version or half a bag for the economy model. But care is required with using economy concrete. It must be made and cured properly with quality sand and cement. Otherwise it may crack, which is not such a good idea on a toilet. The family may decide to grow trees some years and make humus in other years. The options are open and available.

### **Protecting the pit – ring beam and brick linings**

If the soil is firm and a light superstructure is used, and particularly for the *Arborloo*, it may not be necessary to protect the pit at all, since it will be used for a limited period of time (up to 12 months) and the chances of collapse are minimal. However, it is always best to lay the

concrete slab above ground level to avoid erosion due to surface water flowing during the rains. Composting does not work very well in very wet conditions and it is best to avoid pit flooding. So it is desirable to build a ring of bricks around the rim of pit, on which the slab is mounted. Such a ring of bricks is called a “ring beam.” But not all *Arborloos* are built with them.



**These *Arborloos* built in Embanweni, Malawi, where the soil is firm, do not have any form of pit protection. The 0.8m diameter concrete slab is laid directly over a 0.6m diameter hole and the simple superstructure built on top. The pits are dug about 1.0m deep.**

In most other cases where the structures are made of light traditional materials like poles and grass, it is best to mount the concrete slab on a “ring beam.” This raises the slab above ground level and helps to reduce the chances of pit flooding during the rains and also stabilises the whole unit. This is true for both the *Arborloo* and the *Fossa alterna*. In most cases where the soil is moderately firm and stable, and the superstructures are not made of bricks, the ring beam may be all that is required for pit protection.

Only when the superstructure is heavy and built with bricks, must the pit be fully lined with bricks. But since most of the toilets described here do not use bricks, they do not require fully lined pits. In any case the *Arborloo* will rarely be made of bricks and is relocated once or twice a year and the pit may need little protection unless the ground is soft. In most cases a “ring beam” which is constructed in a round or square shape is made up of bricks or concrete and built around the pit head. Or rather the other way round! The ring beam is made first on the site and only then is the pit dug inside it. Then the slab and structure are mounted on top. There are several ways of protecting the pit with a ring beam.

## **Brick ring beams**

These can either be made round, square or rectangular depending on the slab shape chosen. If made of bricks, it is often best to cut down into the soil about 0.3m and dig out an area large enough to lay cement or termite mortared bricks so that the internal measurement of a round pit is at least 0.6m across. The bricks are built up from beneath ground level and then at least one course above ground level. Ring beams for the *Arborloo* do not need to penetrate the earth so far, because the toilet will not remain in the site for more than one year. Many ring beams made for the *Arborloo* in Malawi are made to support slabs which are only 0.6m in diameter, but one meter diameter slabs can be placed over slightly wider pits which last longer.

## METHODS OF PROTECTING A PIT WITH BRICK RING BEAM

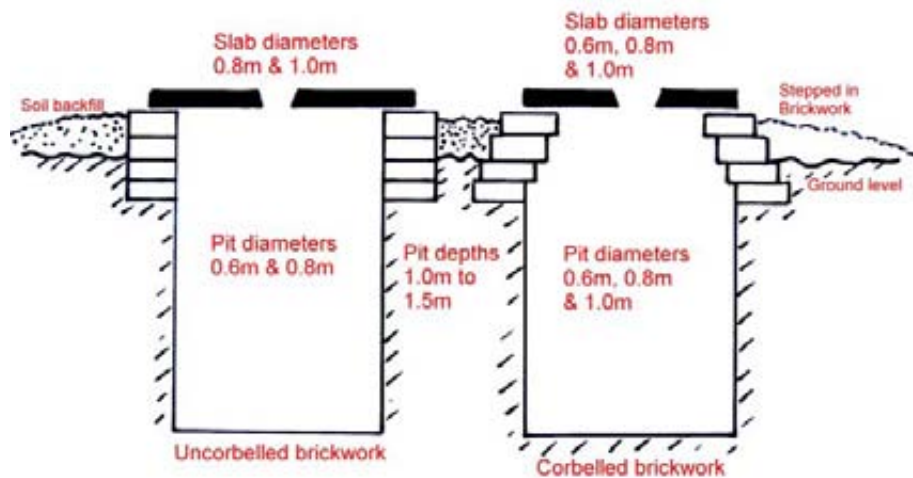

The arrangement of slabs and upper brickwork protection of circular pits. The brickwork can be constructed vertically upwards or “stepped in” a little at each course (corbelling). The corbelling method is more complicated but allows for a slab to be added which is the same diameter as the pit. This is useful, as a slab of a particular diameter can be fitted on a wider pit with greater volume.

### Arrangement of brick “ring beams” for the *Arborloo*

*Arborloo* pits in Malawi are dug round, and using a 0.8m diameter slab the pit is about 0.6m in diameter and about 1m deep with straight sides. The ring of bricks is cement mortared around the rim of the pit, preferably cut down into the softer topsoil and built up to at least one course above ground level. If a 0.8m diameter round slab is placed on top, the ring beam will give 10cm of support all the way round. If a 0.6m diameter slab is used, the pit can be dug to the same diameter, but the layers of brickwork in the ring beam must be stepped in (corbelled) to give sufficient support for the slab. If a 1m diameter slab is used, the internal diameter of the pit and ring beam (without corbelling) can be 0.8m diameter. A 1m diameter pit can be held up by a corbelled ring beam on a pit 1.0m in diameter. With less experience avoid the use of corbelling and use a 0.8m diameter slab mounted over a 0.6m diameter pit or a one metre diameter slab mounted over a 0.8m diameter pit.



The left picture shows the arrangement of bricks in the corbelled (stepped in) method of making a ring beam to protect the pit in Malawi. In the case shown four courses of bricks have been laid. Two courses are laid end to end around the pit and two courses with the bricks laid radially. This provides extra strength. The bricks are best bonded with cement mortar or traditional mortar made of special soil cut from anthills or from other sources. The brick protection usually starts beneath the ground and rises above ground level. On the right a concrete slab is mounted over the ring beam of an *Arborloo*. In this case both the pit and the slab are 0.6m in diameter. The pit was 1.0m deep below ground level. Soil cut from the hole is then placed back around the ring beam up to slab level and the structure then built on top. This makes a stable unit.





Another case in Malawi showing corbelled brickwork protecting a shallow pit of an *Arborloo*. Once again the diameter of both the pit and slab is 0.6m. Here the poles for the structure have been mounted in the ground before soil from the pit soil is placed back around the brickwork up to slab level.



A brick ring beam being built at Kufunda training centre, Ruwa, Zimbabwe. In this case two courses of bricks are laid on top of each other without any corbelling as this is considered easier for villagers. The bricks are mortared with local ant hill soil which resists erosion. The 0.8m diameter hole is dug inside the ring beam and the soil placed around the ring beam and rammed in place. The 1m slab is then fitted.

## Making concrete ring beams

Making toilet components in concrete is usually a good investment. If well made and cured, concrete lasts for decades, and its services can be relied on for generations. Thus a well made concrete ring beam (or two in the case of the *Fossa alterna*) should last indefinitely if cared for, and will not require reconstruction. This also applies to the slab which should always be made in concrete.

The concrete ring beam can be used in both the *Arborloo* and the *Fossa alterna*. The *Arborloo* will use one ring beam, the *Fossa alterna*, two ring beams. This system of construction is used in some parts of Zimbabwe and ring beams and concrete slabs are either round or rectangular in shape. Normally round ring beams are used for the *Arborloo* and rectangular ring beams for the *Fossa alterna*, but these are interchangeable.

## Making round concrete ring beams



In this case a concrete ring beam has been made in a circular shape with a mix of 10 litres cement and 30 litres quality river sand. The mould is made from bricks over a plastic sheet. For the inner ring of bricks a mix of full and half bricks has been used. Spaces between bricks in the inner ring have been filled with segments of stiff plastic. The inner diameter of the concrete ring beam is 85cm and the outer diameter 115cm. This provides for a ring beam width of 15cm all round. Half the mix (5 litres cement mixed with 15 litres sand) is made up first and added between the two brick rings. Then one circle of 4mm wire is placed on the cement midway between the bricks. If in sections the ends of the wire should be slightly bent.



The second half of the full mix is then made up and added to the mould and smoothed off with a wooden float. Two handles are added, one at each side of the ring beam. The beam is then covered with plastic and left overnight. The following morning it is watered down, covered and kept wet for another 10 days before being moved. The fully cured ring beam is then taken to the toilet site and placed on the ground and levelled off. A hole is dug down within the ring beam down to a depth of between 1m and 1.5m. The removed soil is placed around the ring beam and rammed in place (right photo). The matching 1 metre diameter slab can now be fitted (see later). This is followed by the construction of the superstructure.

## Concrete slabs

The concrete slab is an essential part of any toilet. Once well made and well cured it should last almost for ever. So it is worth investing in the cement and good ingredients right from the start. Once a good concrete slab has been made, it can be fitted on various types of toilet including the *Arborloo* and *Fossa alterna*. The ingredients are fresh cement, clean sharp river sand and some 3 – 4mm diameter wire for reinforcing. Even better if granite chips can be found to mix with the sand, but it is not easy to find in most rural locations. The cement should be fresh, since over time its ability to make good concrete does fall off. Also the type of sand is important. Pit sand dug out of the ground will not do. Clean river sand taken from the river and washed is best. It should have a range of sizes of sand including some chips and very small stones. Also some reinforcing wire is required. It does not need to be thick steel bar. It can be wires between 3mm - 4mm in diameter. 3mm wire is fine. Concrete slabs are cast in a mould which is normally made of bricks or wooden planks depending on the shape.



It is best to lay the concrete over plastic sheet, as this retains the ingredients and helps to improve the final strength. The wire is placed inside the concrete half way up, so half the mix is added to the mould first, the wire is added, then the final part of the mix is added and smoothed down with a steel float. A hole is made for squatting and a special mould is required for this. It also helps to add handles, made from lengths of 8 - 10mm steel bar. These make lifting the slab easier. A most important aspect of making concrete is the curing. Concrete sets quite quickly and within a day can be quite hard. But it takes much longer to develop strength. The concrete cannot develop strength if it is allowed to dry out. So a curing slab must be kept wet at all times. Also the longer the curing time, the stronger the slab will become. So it is best to keep the slab wet and cure for at least a week before it is moved. For the more economic slabs using a 6:1 mix, 10 days curing is recommended. It is also best kept the slab under a plastic sheet or at least under a layer of wet sand to keep it wet. If properly made, a well cured concrete slab will last indefinitely. It is a good investment in money, time and effort.



**Concrete slabs are a very important part of the structure of all pit toilets. They are not difficult to make if the simple constructional details are followed. Making concrete components is a very good way of investing money for the future. If well made, concrete lasts almost for ever. Here school children make a concrete slab in Mombasa, Kenya**

### **Making round concrete slabs**

Round slabs are used a great deal in Malawi, and increasingly in Zimbabwe and suit the *Arborloo* and *Fossa alterna* principles very well. Very often round slabs are made in a dome shape in Malawi without reinforcing. But concrete slabs are easier to make flat with a little reinforcing. Reinforcing wires are generally available in most local hardware stores. Some of the new generation round slabs are also made with handles for use in eco toilets so that the movement of the slab from one location to the next is made easy.

## Making a strong 1 metre diameter round concrete slab



The mould is made from bricks laid on plastic sheet. This slab is 1 metre in diameter and made with a total of 10 litres cement (quarter bag) and 30 litres quality river sand. Four pieces of wire 4mm in diameter each 90cm long are used as reinforcing. The mould for the squat hole is placed slightly to the rear of centre. The same size slab can also be made with a weaker mix of 6 litres cement and 30 litres quality river sand (5:1). In this case the construction and curing must be undertaken meticulously.



Half the mix is made first with 5 litres cement and 15 litre river sand in a wheelbarrow. The concrete slurry is added to the base of the mould and distributed evenly over the whole surface. The four wires are then added as shown at right angles to each other.



Another mix of 5 litres cement and 15 litres river sand is now made up as before and added to the mould over the wire reinforcing. The concrete is levelled with a wooden float and then finished off with a steel float. Two handles are placed on either side of the squat hole to make picking up easier and more hygienic. 10mm steel bar is best for the handle if it is available. The concrete is left overnight and the following morning watered down and then kept wet for about 7 days. The slab is only 32mm thick, and relatively light to pick up or roll into place. The 3:1 mix is a very strong one. This slab is made to fit over the circular concrete ring beam shown earlier or over a ring beam made of bricks. This is shown later.



## Making an “economy” 1m diameter concrete slab and matching ring beam

Using great care, it is possible to make a 1m diameter concrete slab using only 5 litres of cement mixed with 30 litres of river sand (6:1). A matching ring beam can also be made with the same mix. The same technique is used as described earlier for the 1m diameter slab and ring beam made with a 3:1 mix. So it is possible, with great care, to make both a slab and a ring beam with only 10 litres (1/4 bag) of cement. But there is not much room for error. The following list of essentials are required: 1) The cement should be fresh. 2) The sand should be quality river sand. 3) The slab should be made in a mould mounted over plastic sheet. 4) The slab should be reinforced with 3 or 4mm wire (4 pieces). 5) The cement and sand should be measured carefully. 6) The dry materials of cement and sand should be thoroughly mixed before adding water. 7) Water should be added so the final mix is not too wet. 8) The concrete should be thoroughly mixed again. 9) Half the concrete mix should be added to the mould first and levelled all over with a trowel. 10) The four 90 cm long 3 - 4mm reinforcing wires are laid in a square formation around the squat hole mould. 11) The second half of the concrete mix is then added, levelled off, compacted and smoothed down with a wooden float. 12) The concrete work is finished off with a steel float, paying particular attention to the area around the squat hole and the rim of the slab. 13) Steel handles are placed on either side of the slab and the concrete smoothed off. 14) The squat hole mould is carefully removed after an hour and the edges made neat with a trowel. 15) The slab is covered with plastic sheet overnight. 16) The following morning the slab is watered down. The slab is kept wet under the plastic sheet and not moved for 10 days. 17) The slab is then lifted and taken to the ring beam (brick or concrete) and laid on a bed of clay, anthill mortar or weak cement mortar.



A measuring device can be made with a 2 litre plastic milk bottle cut in half. Measured amounts of water are added and marks made on the bottle. When full the measuring device holds one litre of material. A mark showing half a litre is also shown. For this slab 5 litres of cement is mixed with 30 litres sand (6:1).



The first half of the mix is added to the mould and levelled off and smoothed down. The 4mm reinforcing wires are added and the second half of the mix is then added. It is tamped down and levelled off with a wooden float. The slab is also steel floated. Steel handles are added. It is given 10 days to cure, being kept wet and covered throughout this period. Good ingredients, mixing and curing are essential. A well made and well cured “economy” slab is quite strong enough for the job as the photo shows.



## Sequence of fitting the circular concrete ring beam and slab.

The construction of a 1 metre diameter concrete slab with matching concrete ring beam using between one quarter and half a 50kg bag of cement (depending on the mixture used) is a good investment for the family. The advantage of the concrete ring beam, as opposed to the brick one, is that it is permanent, will last almost indefinitely and can easily be moved from one location to the next. The circular slab and ring beam are easy to move because it can be rolled.

Where the concrete ring beam/concrete slab combination is used as an *Arborloo*, the toilet is used for as long as the pit can accept the combination of excreta, soil, ash and leaves. Once full, the entire structure (ring beam, slab, house) is moved to the next location. The ring beam is put in place, the pit excavated within it, the slab mounted and the superstructure put in place again or reconstructed. At each full pit site soil is added to the pit contents and a tree planted.

But the system can also be used to make humus (like the *Fossa alterna*) for the vegetable garden. Using these smaller ring beams and matching 1 metre diameter slabs, 3 ring beams and one slab can be made from between half and one 50 kg bag of cement, depending on the mix. In this case the 3 ring beams are made and located on site and remain in their original locations. The matching slab and superstructure rotates around them in sequence. Since the pits are smaller than the normal *Fossa alterna* pit, the slab and structure may need to be relocated every 6 months. But by the time the third pit has been filled, the humus in the first pit will have had adequate time to compost. The compost can be dug out and the slab and structure relocated on its original site. In this way there will be a never ending source of humus. If for some reason the ground starts to fail, the ring beam can be moved to a new site.



The site of the toilet is first levelled off with a hoe and the rim beam placed firmly on the ground. The hole is then dug inside the ring beam down to a depth of 1 to 1.5 metres. Some of the excavated soil is placed around the ring beam and rammed in place. This will help to prevent rain water undermining the pit.



The slab is then brought close by. A layer of clay, cement or termite mortar is then laid on the ring beam, The slab laid centrally on the ring beam. Now the superstructure must be built around the slab.

## Fitting the slabs

Once the slab has cured properly it is removed from the mould, washed down with water and fitted over the ring beam at the head of the pit. It is a good idea to bed the slab in some weak cement mortar laid over the beam to allow the slab to settle properly (slabs and beams are never made perfectly level). Alternatively some anthill mortar can be used. Hopefully at this stage two sacks of dry leaves will also have been deposited into the base of the pit to help the composting process. Once this has been done, the time has come to fit the superstructure.

## Optional pedestal

It is possible to fit a pedestal on to any pit or eco-toilet, but the slab must be made specifically for it – with a 30cm diameter hole, rather than the 30cm X 19cm squat hole. This includes the *Arborloo*. Commercial pedestals are available, but expensive. It is possible to make a strong home made pedestal at much lower cost. As time passes pedestals are becoming more popular in several countries where squatting was once the norm. Those who are more elderly greatly appreciate them. Constructional methods for home made pedestals are described later in this book.



Home made pedestal placed on the slab. The pedestal is smart, cheap and durable.

## Superstructures

Toilet superstructures are built mainly for privacy, and protection from the weather. For the *Arborloo*, they need to be portable or easily moved from one location to the next. A large range of materials can be used for the construction of the superstructure. These include poles and grass, frames made from poles, reeds, bamboo, wooden planks and steel etc with a variety of coverings for privacy. Coverings include grass, reeds, reed mats, plastic sheet, shade cloth, timber planks, iron sheeting, Hinged (using car tyres) or hanging doors may be fitted or the structure can be made without a door in a square spiral configuration. The type of superstructure chosen may depend on the availability of local materials. There is enormous variation in the type of structure which can be built, both for the *Arborloo* and the *Fossa alterna*. The finished superstructure for both the *Arborloo* and *Fossa alterna* can best be illustrated by showing and describing photos taken from a number of countries including Malawi, Mozambique, Kenya, South Africa and Zimbabwe



## The Arborloo photo gallery



Left, the simplest superstructure – poles and grass – no door - no roof. Thanks to Jim Latham, Eco-Ed Trust. Right, slightly more advanced – pole and grass structure with door and roof. Low cost and very durable door hinges can be made with cut sections of car tyres. Photo taken an Fambidzanai – Permaculture Training Centre



Left, simple portable structure made from poles and grass in Mozambique. This one has no door but has a roof, which has just been removed. The various sections are in panels and can be taken apart. Photo taken in Niassa Province. Thanks to Ned Breslin, WaterAid. Right, *Arborloo* structure built at Kusa Village, near Kisumu. Thanks to Osielala and RELMA



Woven basket superstructure from Malawi. Thanks to Steven Sugden and WaterAid. Woven basket structure on *Arborloo* in Northern Malawi. The door is made from sacking. A neat and effective unit. Photo: thanks to Jim McGill, Embangweni eco-san project.

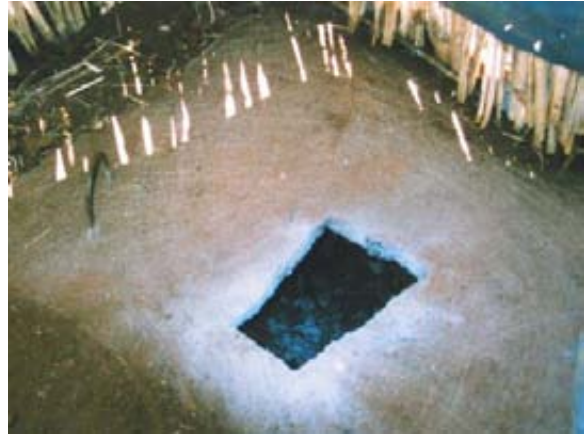

**Arborloo structure with low cost vent pipe. On the left the structure is made of poles and grass with low cost vent made with sacking and cement slurry. The interior is shown on the right. Thanks to staff of Mvuramanzi Trust. Zimbabwe.**



**Structure made of bamboo and reeds. The four main bamboo uprights are anchored in the ground. They can be protected to a certain extent from ants with old engine oil or wood ash. The hinge for the door is made of old car tyre, as shown on the right. This material makes an effective and durable hinge.**



**Structure using small gum poles and old cement packets – also with a door Photo taken at Kufunda Village Ruwa. Thanks to Marianne Knuth. Moving an Arborloo superstructure in Maputaland, South Africa. Note the wooden structure has legs. Thanks to Dave Still and Stephen Nash of Partners in Development.**





Two portable structures at Woodhall Road, Harare. One made of gum poles in sections which are wired together (right). The structure on the left is a steel frame covered with grass walling. Note hand washing device hanging from structure. All toilets should be provided with a hand washing facility. The structure made with steel frame and grass covering is easy to move. This is an excellent system where the frame is light and very durable and will last for many years. Less durable low cost walling materials like grass can be replaced when required. Photo taken at Fambidzanai, near Harare.



Photos of the steel frame *Arborloo* structure with grass walls and door made of sacking cloth. The vent pipe is a low cost home-made type made by wrapping plastic sheeting around a PVC pipe, then applying hessian and cement slurry. The structure has a door with car tyre hinge (see close up).



Simple *Arborloo*'s at the Eco-Ed Trust, Mutorashanga, Zimbabwe. The pole and grass structure is easily taken apart and reconstructed from the original materials. The grass can be replaced every year if required. This type does not have a roof, but a roof is desirable to keep out rain. Thanks to Jim Latham,

## Management of the *Arborloo*

### Daily management of the *Arborloo*

The *Arborloo* is used like a normal pit latrine in that urine, faeces, anal cleansing materials (preferably paper) are added to the pit on a daily basis. In addition and in order to build up the mix of ingredients which assist in the conversion of faeces into humus, it is important to regularly add dry soil and wood ash to the pit, preferably after every visit made for defecation. This material is best made up beforehand in the dry state, stored in sacks or bags and then added to a smaller container within the latrine. About four parts sifted dry soil and one part wood ash are mixed. Half a mug full of the soil/ash mix should be added after every visit made to deposit faeces. It also helps to add leaves to the pit – these improve the texture and nutrient value of the final humus.

It is wise to collect fertile soil in dry weather conditions and store this for future use in the latrine. It can be stored in bags or even in heaps in a part of the garden and covered with a plastic sheet during the rains. Wood ash should also be stored for future use. Although fertile soil is the best for use in the *Arborloo* pit (and also the *Fossa alterna* pit), the actual soil used will depend on what is easily available. The most obvious choice is to store the soil that was dug out of the pit during the initial excavation and re-introduce this back into the pit, every day. Sometimes wood ash may not be available or will be added separately. The most important ingredient to add is soil. Adding wood ash helps a great deal, especially in reducing odours and fly breeding and making the mix slightly more alkaline. Leaves improve the texture and also nutrient levels in the humus and also help to aerate the mass.

Experience over time, by the householder, will show that the best results are obtained when a mix of ingredients is put down the pit. This mix may include: excreta (urine and faeces), paper, topsoil, wood ash and leaves. The exact amount and mix must be judged over time. Clearly it would make no sense to add an excessive amount of soil, as the pit will fill too fast. As a rule of thumb the amount of soil added should approximately equal the volume of the excreta.

These additional materials help to improve the final texture and quality of the humus formed in the pit. It is also very desirable to add a sack full of dried leaves to the base of the pit before use and also a small sack full of leaves to the pit at 3 or 6 monthly intervals to increase the proportion of air and humus like material in the pit. The proportion of addition materials placed in the pit should be about equal to the volume of solids added. About half to a full mug full per visit after faeces have been added. In fact much of the bulk of the excreta will be absorbed into the dry soils and other dry materials (wood ash) added. It is important to add dry soil and dry wood ash to the pit, as these will help to absorb moisture from the excreta. Certainly some of the urine will be absorbed into the pit soil. Excess urine may also percolate into the soil surrounding and under the pit which will enhance its nutrient content prior to root invasion by the tree, even though some also nutrients will be lost.

### No Garbage please !!!

It is also important to avoid placing non-biodegradable materials down the pit. These include rags, plastic sheets and bags, bottles, rubber objects and all manner of other objects that are often put down standard pit latrines. Whilst this part of the management is more important with the *Fossa alterna* where the pit contents are excavated (see next chapter) it is wise also

in the case of the *Arborloo*. It is important that the pit is filled with good soil, not a pile of rubbish mixed with soil.

### **Flooding!**

The conversion of excreta into humus will not take place if the pit is flooded with water. This means that only limited amounts of water should be added to the pit. Good pit drainage very much dependent on soil type and area of soil in the pit available for drainage. Where the ring beam method of pit protection is used a large surface area of soil will be available for pit drainage. Pits lined with bricks or concrete rings do not drain so well.

### **Distributing pit contents**

For the best results, and to ensure the best possible use of the pit volume, it pays for the user to look down the pit from time to time and level the contents. Since dry soil and ash when added to the pit tend to make deposits of excreta less fluid, the pit contents tend to rise up within the pit directly under the squat or pedestal hole. A central mound is thus formed – a process called “turreting.” If the most economical use of the pit volume is to be made, it is very important for this mound to be flattened off from time to time with a stick. This flattening out of the pit contents and the occasional addition of a bucket of water helps to keep the contents moist and well distributed within the pit. These procedures will lengthen the life of the pit.

### **Relocating the *Arborloo***

When the *Arborloo* pit is almost full, the superstructure and slab are removed and put on one side. The ring beam is dug out and removed (or taken apart if made of bricks) from the old site and placed on a new site nearby. It does help to have handles fitted to the concrete ring beam in the case of the *Arborloo*. This makes the movement easier and more hygienic. After the ring beam has been well placed and levelled on the new site, a new hole is dug down within the ring beam, as before, and the ring beam surrounded by soil taken out of the hole. The soil surrounding the ring beam is rammed hard in place.

The slab and superstructure are remounted on the ring beam as before. A seal is made between the ring beam and slab using a weak mix of cement and sand (1:20) or a clay like or termite soil made into mortar. The new location is chosen with care, taking note that the trees once planted will often grow large. Pits should not be closer than 3 metres apart. For trees which are known to grow large 5 metres may be a better distance. In a school setting or family homestead the *Arborloos* may be placed in an area which will turn into a wood lot or fruit tree orchard.

### **Preparations for tree planting**

The contents of the used pit (filled with excreta, soil/ash/leaves etc) are now levelled off and topped up with fertile soil, at least 150mm deep. This soil can come from old compost heaps, fertile soil/leaf litter found under trees or any other place where the soil looks good. The aim is to plant the young tree in the topsoil so the roots come nowhere near the excreta layer. The more energetic can actually cover the pit contents first with soil and ram it into the mass with a pole, thus increasing the soil content of the pit. Ramming in soil actually promotes the conversion process. After ramming in extra soil into the pit contents, the final topsoil layer is

added to completely cover the excreta lay and prepare it for tree planting. This final layer of topsoil should be at least 150mm thick.

### **Natural growth of trees in latrine pits**

When a latrine pit is abandoned the contents contract in volume. Seeds of various types may fall into the depression formed and start to germinate. The kitchen wastes may also be thrown into such an abandoned pit. Pumpkin and tomato seeds will almost certainly germinate in such an environment. The same holds true for the seeds of trees that may fall into the old pit depression. The fact that this process occurs in Nature suggests that the medium found in these pits offers a suitable medium for plant growth.



**A new latrine is being built to the left. On the right is the depression left from an old latrine pit. Close inspection reveals that an indigenous tree is starting to grow there. Photo a Kusa Village, Kenya.**

### **The importance of trees**

The most important aspect of the promotion of the *Arborloo* principle is that a link is made between the worlds of sanitation and forestry. The world lacks trees and they have such a beauty and value of their own which adds much to the world we live in. There is no part of the world that could not benefit by having more trees. This applies particularly to those barren parts of the developing world where trees may have been lost years ago and the resulting effects of erosion or reduced soil fertility are being felt. By linking the production of new trees with the reuse of human excreta we combine a problem (the disposal of human excreta) with a need for new trees and the many benefits they may bring forth. With each tree a story can be told. After ten years of use an *Arborloo* can leave behind a fine orchard of fruit trees or a wood lot of gums suitable for fuel or building. The tree is one of nature's marvels. It can be the provider of food, fuel, building materials, and medicine. It helps to stabilise the soil and offers shade. It provides leaf litter and thus provides additional fertility to the soil. It also provides beauty and richness to our environment. It helps to reduce erosion. The *Arborloo* is an elegant solution, which in the simplest possible way is able to provide an effective solution for low cost sanitation, adds greatly to the promotion of trees, and also offers an excellent example of recycling human excreta. Not surprisingly it is gaining popularity in many African countries.





**Magnificent trees near Lake Victoria**

The time has certainly arrived when we need to make the world of sanitation more interesting. And certainly one effective way of doing this is to make strong links between the sanitary world and that of agriculture in its many forms. Ecological sanitation has come at the right time, to offer us a practical way of doing this. That is what is good about ecological sanitation. It brings the worlds of agriculture, forestry, horticulture, food, fruit, herbs, natural medicines, fuel and many other things together.

Every means possible should be taken to grow more trees of all sorts, exotic trees and also indigenous trees. The links made between sanitation and the propagation of more trees is an important one. The value of the nutrients available in excreta, even if they exist below ground level, can be realised and witnessed with ease. Fruit trees grow very healthily on such organic pits if planted correctly, watered and protected. The fruits when tasted are delicious. What simpler and better way of demonstrating the concept of ecological sanitation and “closing the loop!”

The concept of the *Arborloo* is being promoted and tested in countries like Kenya, Mozambique, Malawi, Zambia, as well as Zimbabwe, where it is thought to have considerable practical application. The potential for its use throughout Africa is enormous. Because the method and concept is simple and yet retains the basic elements of ecological sanitation, it is thought of as a good first step along a route of increasing sophistication within the realm of ecological sanitation. It is, for instance, possible to upgrade the *Arborloo* and make a *Fossa alterna*, moving quite simply from a series of single pits into a permanently sited alternating double pit system (*Fossa alterna*). By slight modification or replacement of the latrine slab (making a vent pipe hole), the system can be upgraded further to a VIP latrine. The *Arborloo* is the very best method of entering the world of ecological sanitation. The method is simple and cheap and there is no handling of processed human wastes. Many people may prefer to start off with this option. It is an excellent “entry point” for ecological sanitation.

## Examples of *Arborloo* programmes

### The *Arborloo* in Malawi

The **Arborloo** is very popular in Malawi perhaps because trees have been planted on old latrine pits for generations. Where the ground is hard the slab may be placed directly on the pit cut in the ground. In softer ground a ring beam or corbelled brick ring wall is built up from below ground level to above ground level and backfilled. Round slabs are very common in Malawi. As many as 8 slabs 0.8m in diameter can be made from a single bag of cement (left). Many domed slabs have no reinforcing. The one shown at left has 2 metres of 2.5mm wire placed in it. Photos taken in Phalombe district.



Most *Arborloos* in Malawi are of simple construction using poles and grass Photos taken in Embangweni (left) and Phalombe (right). Thanks to CCAP and COMWASH.

### Making the 0.8m diameter round slab in Malawi



Making a round 0.8m diameter concrete slab in Malawi with sharp river sand and cement. When the river sand is of high quality, the addition of granite stones may be unnecessary. In this case a tin strip 40mm deep is formed into a circle 0.8m in diameter and supported by bricks. It is laid over a sheet of plastic. 4 wires are cut as reinforcing. In this case 2 metres of 2.5mm wire has been cut into 4 pieces (2 X 0.55m and 2 X 0.45m). 3mm or 4mm wire can also be used. The mix of sharp river sand and cement is 4 to 1(20 litres river sand and 5 litres cement). 8 slabs can be made from one 50 kg bag of cement using this method. High quality river sand and proper curing are important.





The sand and cement are thoroughly mixed and water is added to make a stiff moist concrete. The squat hole mould is added in the centre. Half the volume is added first, then the reinforcing wires, then the final part of the mix is added and trowelled flat and finished off with a steel float. The tin and squat hole moulds are removed and the slab covered with plastic sheet and left for 10 days to cure being kept wet throughout the curing process after setting. Photos taken in Phalombe. Thanks to COMWASH

### The 1.0m diameter round slab in Malawi



Making a round 1.0m diameter concrete slab in Phalombe with high quality sharp river sand and cement. In this case a circle of bricks one metre in diameter is laid on the ground. Some sand is added to level off. A sheet of plastic is then laid inside the brick mould. 4 wires are cut as reinforcing. In this case 3 metres of 2.5mm wire has been cut into 4 pieces (2 X 0.7m and 2 X 0.8m). 3mm or 4mm wire can also be used. The mix of sharp river sand and cement is 3 to 1 (30 litres river sand and 10 litres cement). The process is the same as for the 0.8m slab. Cure for 10 days and keep wet at all times after setting. 4 slabs can be made from one 50 kg bag of cement using this method. High quality river sand and proper curing are important. Thanks to COMWASH





A quality hand made 0.8m diameter domed circular slab made with a mix of stone chips, river sand and cement with footrests and handles. No reinforcing has been used. With this method 4 slabs can be made from a single 50 kg bag of cement. This is mounted over a circle of bricks laid as a ring beam for the *Arborloo* as shown on the right. Where the slab is used on a *Fossa alterna* it is mounted on a ring beam made of bricks (or concrete) at the top of the pit ( where the soil is firm) or on the uppermost course of bricks in a fully lined pit which extends above ground level. The larger diameter one metre slab is best used on the *Fossa alterna* and the smaller 0.8m diameter slab on the *Arborloo*.



On the left a pole and grass *Arborloo* in the Phalombe plain. Thanks to COMWASH. On the right a brick *Arborloo* built in a peri urban settlement near Lilongwe, Malawi. Thanks to WaterAid, Malawi.



## Sequence of building low cost *Arborloo* in Zimbabwe at Kufunda Village

### Making the 1 metre diameter concrete slab



The circle for the 1 metre diameter slab mould is marked on levelled ground and bricks placed together in a circle



Plastic sheet is placed inside the mould and the concrete mix is made up in a wheel barrow (30 litres of good clean river sand and 5 litres of fresh cement). This is thoroughly mixed before and after adding water to make the concrete mix. Using this economy mix 8 slabs can be made with a single 50kg bag of cement.



A mould for the squat hole is made with a bucket or with bricks as shown here. Half the mix (about 17 litres) is added to the mould first and levelled off. The four 90cm pieces of wire (3 – 4mm thick) are added to make a wire square around the squat hole. Then the remaining concrete is added, levelled, tamped down hard and finished off with a wooden float and steel trowel.





Two thick wire handles are made up and inserted in the concrete on either side of the slab. A little extra cement can be added around the handles for extra strength. After an hour or two the mould for the squat hole is removed and the hole made neat with a trowel. The slab is covered with plastic sheet and left overnight. In the morning it is soaked in water and covered again. It is kept wet for 10 days under the plastic sheet. The longer it is kept wet under plastic sheet the stronger it will become.

### Making the brick ring beam



A suitable site for the toilet is located, preferably on slightly raised ground. A circle is marked on the ground 80cm in diameter. A ring of fired bricks is laid on the chosen site around the mark to start making the ring beam. Anthill mortar is gathered, broken up and mixed with water to make a stiff mortar.



The brick ring beam is bonded together with anthill mortar, in between and above the bricks. Two courses of bricks are laid, one above the other and placed so that the upper bricks lay over the joint between the lower bricks. (note - if bricks are not available a concrete ring beam can be made instead).





The pit is dug out down to 1 – 1.5 metres and the extracted soil placed around the ring beam and rammed in place. The ring beam and surrounding soil will help to make the toilet stable.



The slab is then moved and placed over the ring beam embedded in a layer of anthill mortar to keep it steady. The superstructure is now built with locally available materials like wooden poles and grass).

### Making a concrete ring beam



Two circles of bricks are laid over a plastic sheet. They are arranged so they form a mould in which the 6:1 mix of river sand (30 litres) and cement (5 litres) is placed. The open joints formed between the bricks of the inner circle of bricks can be filled with wet sand before adding the concrete mix. The mix is made in a wheel barrow and thoroughly mixed. Half the mix is added first to the mould. This is followed by a complete circle of 3 – 4mm wire. The remaining half of the mix is now added. The concrete is beaten down hard with bricks (see left photo) and smoothed down. The ring beam is then covered with plastic sheet and left over night. The following morning it is soaked in water and left to cure for 10 days. It is kept wet and under the plastic sheet throughout the curing period. After 10 days it can be lifted and placed on to the toilet site. A pit 1m – 1.5m is dug inside the ring beam. A sack of leaves is added and the concrete slab placed on top (in anthill mortar). The structure is then built around the slab. Soil, ash and leaves are added frequently to the pit contents to encourage the formation of good compost. For more detail see Appendix on low cost construction of *Arborloo*. Thanks to Marianne Knuth and Kufunda Village.



## The Kufunda outreach programme in the villages

Trainees from Kufunda go back to their villages and show others how to cast simple concrete slabs and build the *Arborloo*. Whilst the cost of the cement is low (one 50 kg bag costing around USD8.50 can serve five families), most families prefer to spend their scarce resources on food or school fees. Consequently the concept of a “Compost Toilet Starter Kit” has been introduced. The Starter kit provides enough cement to make a one metre diameter concrete slab and also provides a young tree and simple instructions. The Kit contains 8 litres of cement (one fifth of a 50 kg bag), which is mixed with 30 litres of river sand to make the concrete slab. Some wire is also required. Both river sand and wire are available in most villages. Ring beams are normally made with local fired bricks bonded together with termite mortar. Structures are normally built in the simplest way at first – made from grass and poles. Often there is no roof at first. But even at this stage, a significant step forward has been made to the provision of sanitation in the village. The regular addition of soil and wood ash ensures significant reductions in both odour and fly breeding without the use of a vent pipe. Simple as it is, the construction of the *Arborloo* signifies a significant step forward in the provision of low cost and affordable sanitation.

Once the *Arborloo* has been made, the toilet can be upgraded at a later date, using the same slab with a more permanent concrete ring beam, and a more substantial house fitted with a roof. The family may choose to build a second or third pit and use the *Fossa alterna* (alternating pit) system in time, rotating the use of the toilet between two or three pits. This becomes a more obvious method, once the value of the humus formed in the pit has been seen by family members. The pit humus can significantly increase the production of vegetables and also maize, especially when combined with the use of urine. Such advantages become very apparent when a combination of humus and urine are used on very poor sandy soils – soils which are all too common in rural Zimbabwe and other parts of the sub-region. Once the effects of the humus on tree, vegetable or maize production have been witnessed, the popularity of the toilet system increases. Also once the method of making concrete slabs has been learned, the family may choose to make more slabs of its own.

The stage has not yet been reached when the enhanced growth of fruit trees has been experienced in this programme, which in its infancy. Programmes in Malawi and Mozambique are more advanced. One thing is certain – families are very pleased with their own efforts in finally being able to construct their own toilet at minimum cost and without the use of artisans and labourers. Women are particularly proud that they can construct the system, normally the role of the men. In programmes promoted by Kufunda in Rusape, Ruwa, Mondoro and Zvimba, women are the most active participants and also the best instructors.

The Starter Kit concept, currently being tested, provides an incentive for the family member (often a woman) to start the process off. The Starter Kit also provides small trees (currently mulberry) which are planted, first in pots, at the same time as the toilet is built. Later, the partly grown trees are transferred from the pot to a generous layer of soil placed above the filled *Arborloo* pit. With watering, care and attention, the tree can grow into a considerable family asset later. All the instructions are provided in the Kit. It is an interesting and low cost method of promoting the uptake of low cost sanitation. Other excellent promotional methods are also being tried by WaterAid in Malawi and Mozambique and COMWASH in Malawi.



Participants at a “compost toilet workshop” in Mondoro are busy making the concrete slab. Instructions in the local language – Shona – are available. With the cement provided in the kit, a strong one metre diameter concrete slab can be built together with local river sand and some wire. The slab is flat and easy to construct. The importance of proper curing is emphasised. Cover with plastic sheet and after hardening keep wet for at least a week. The important aspect of this programme is that local villagers who are neither artisans or builders by trade acquire the skills. By far the greatest number of participants are women. In Mondoro, it is the women who train others to make the slab and toilet.



The ring beam is an important part of the structure, as it elevates the toilet slab above ground level and helps to protect the unlined shallow pit. Most ring beams are made with local fired bricks and termite mortar. The slab sits on top of the beam and then the structure is built around this. On the right a group of villagers attend the compost toilet workshop in Mondoro.



A sack of soil near the home made slab on an *Arborloo*. The finished *Arborloo* made in the simplest way, provides a safe way of disposing of excreta. The facility offers privacy, with almost no smell or fly nuisance. It is an important first step in the provision of sanitation for low income families. These photos were taken in the Mondoro district.

## 5. How to build and manage the *Fossa alterna*

The *Fossa alterna* is a simple alternating pit toilet system designed specifically to make humus suitable for agriculture. It is based on a twin pit system - the use of the toilet itself alternating between two permanently sited shallow pits. The toilet is managed in such a way that the conversion of human excreta into humus takes place within 12 months. After 12 months of composting the humus is dug out and used on the garden. The pit volume is calculated so that this 12 month period is less than the filling time of the pit when used by a small to medium sized family. This means that the *Fossa alterna* can be used continuously on the same site, almost indefinitely, simply by alternating between one pit and the second, with the humus being excavated once a year, thus making available an empty pit - every year.



**The *Fossa alterna* is designed to make humus from human excreta. It has two shallow pits protected by two concrete ring beams, a single concrete slab and a superstructure, in this case made from gum poles and reed mats. This unit is also equipped with a low cost home-made pedestal, a vent pipe and hand washing device. The system is simple and can be made at low cost. Photo taken in Marlborough, Harare.**

As in the *Arborloo*, the conversion of excreta into humus in such a short space of time (12 months) becomes possible because extra ingredients, like topsoil, wood ash and leaves are added regularly to the pit contents. These extra ingredients alter the biological makeup of the pit contents, and also make it far more aerobic than would be the case with a deep pit latrine filled with excreta alone. Adding soil (especially fertile topsoil) and leaves brings into the mix a myriad of beneficial soil organisms such as beneficial bacteria, fungi, even worms and insects which excavate the soil and help to process the excreta. The addition of leaves (and other vegetable matter) increases the air content. Unlike solid excreta alone, this combination of ingredients readily converts into humus if sufficient quantities of the extra ingredients are added. The volume of soil, ash and leaves added to the pit should be about equal to the volume of faeces added. And it should be well distributed – in other words, the various ingredients should be added regularly. The conversion is improved if the soil itself is fertile and humus like. Adding clods of wet clay soil from time to time will not result in the desired effect. Neither will the occasional sprinkling of soil or ash on a huge volume of excreta held in the pit. The proportion of soil, ash and leaves should be significant and well distributed and should make up about half the volume of the pit. These important facts should be known to those people who are being introduced to the *Fossa alterna*. In adding this combination of ingredients the process of decomposition within the pit is quite different to the one that normally takes place in the deep pit latrine. In the deep pit latrine, it is only excreta which enters the pit, together with garbage, and this combination may take many years to convert

into a useful humus, depending on the conditions. Under such an inefficient conversion - the alternate use of twin pits on a regular basis would be impossible. Thus the process of humus formation in the shallow pit systems used in the *Fossa alterna* is a significant departure from the conventional system seen in conventional pit latrines, which are used world wide.

The *Fossa alterna* could be classified as a double vault pit latrine, but it is different in so many fundamental ways, that it has been given a specific name which distinguishes it from other twin pit systems.

\* The *Fossa alterna* is specifically designed to make humus from human excreta (urine and faeces combined) in an efficient manner. This is achieved by the regular and generous addition of soil, wood ash and leaves together with the excreta.

\* An important requirement of the *Fossa alterna* is to produce a relatively safe and valuable humus in the 1.2 – 1.5 meter deep composting pit within the space of 12 months. This is less than the time taken for a family of six persons to fill a shallow pit, which the *Fossa alterna* is designed to serve. This conversion from human excreta into humus could not be achieved within a year in a normal pit latrine, and the addition of the soil, ash and other ingredients into the pit is essential for this process. It is this feature which distinguishes the *Fossa alterna* from other double vault pit latrines. The aim therefore is to roughly match the rate of conversion of the excreta into humus in the one pit with the rate of filling of the second pit. When this is achieved it is possible to change sides once a year, with a regular out-put of humus being achieved each year. In practice a family should take a little more than a year to fill each pit and the conversion into humus is achieved in a little less than a year. So there is a safety margin built in.

\* The twin pits of the *Fossa alterna* are shallow, each about 1.2 meters deep, with 1.5 meters being a maximum. This makes excavation for the family relatively easy. The formation of humus takes place under reduced conditions of compaction (which would be the case in deeper pits). The excavation of humus is also usually easier than digging out the original pit. The shallowness of the pit also reduces the risks of contamination of underground water from the system, partly because the waste materials are contained further away from the water table and partly because the conversion of excreta into a much safer humus is accelerated.

\* The pit which has been filled with a combination of excreta, soil, wood ash and leaves is exposed in such a way that it is easy to excavate. It is important that the pit is topped up with additional soil and leaves and left to compost for 12 months. For safety reasons it may be covered with a wooden cover. Ease of excavation is important.

\* There is only one latrine slab used in the system. This is deliberate, so that only one pit can be used at one time. This avoids the problem seen in some other double pit systems which are equipped with two slabs - allowing both pits to be used simultaneously. The concept of the *Fossa alterna* cannot work if both pits are used simultaneously.

\* The system can be equipped with a portable structure, like the *Arborloo*, so that transferral of the superstructure from one pit to the other is easy and convenient. This is not an essential requirement however, and most *Fossa alternae* in Mozambique and Malawi house both pits within a single permanently sited superstructure.



\* The *Fossa alterna* is designed to use the nutrients derived from urine and faeces in combination which are composted together with the soil entering the pit. The resulting humus is rich in nutrients, derived from both the urine and faeces (see later soil analyses). The *Fossa alterna* concept of producing humus in shallow pits can be used in combination with urine diverting pedestals, but this increases the cost and complexity of the unit. The urine diversion concept is best used in combination with above-the-ground vaults, but it will work on shallow pits as well

\* The system is adaptable, - if overloaded by heavy use - a third or even fourth pit can and should be built and the single slab and superstructure can be used on a rotational basis between the series of shallow pits. The aim must always be to allow for at least one year of composting.



***Fossa alterna* in Epworth near Harare. It has two shallow pits, a single concrete slab and single superstructure, made with a light steel frame covered with grass. The *Fossa alterna* was initially designed for per-urban use on medium sized plots, but can be used on smaller plots and also in the rural areas.**

Like the *Arborloo*, the *Fossa alterna* attempts to fulfil all the basic requirements of a toilet used under the umbrella of ecological sanitation. The recycling of human excreta is achieved in a simple manner and the end product, in the form of humus, is relatively easy to excavate and introduce directly into the garden or into bags for future use or. An entirely natural process of “ambient temperature composting” takes place in the pit. Pit content temperatures rarely exceed 25 degree centigrade in Southern Africa. Where the *Fossa alterna* differs from the *Arborloo* is that the humus will be excavated from the pit, and hand contact will subsequently be made with it. Certainly when it is mixed with topsoil, and vegetables are planted, the material will be handled. Thus the health implications are important to consider.

After one year, properly composted pit humus is infinitely safer to handle than hands soiled in the toilet. It is important to wash hands after handling and this would be a normal procedure when handling garden compost before eating. It is essential that the recommended materials (soil, ash and leaves) are added to the pit regularly and a full 12 month period of composting is allowed. Without this method of management, where the excreta builds up without any, or very little additional material to help it compost, the excreta will not change in the desired way within the recommended 12 month period. Then, handling the resulting semi composted material may pose a health threat. Also *Fossa alterna* humus has not yet been investigated for the inactivation of viable helminth (round worm) eggs to date. Existing data shows that within 12 months the great majority of helminth eggs will have been rendered non viable for composted human sludge (Martin Strauss. 1990). Thus there is a small element of risk

associated with handling the *Fossa alterna* humus, but this risk is infinitely less than handling many other sources of potential contamination in the environment in which the *Fossa alterna* was designed to work. Contact with the unwashed hands of another person who has attended the toilet or with a contaminated door or towel may constitute an infinitely greater health threat, than handling well composted excreta dug out of the *Fossa alterna* pit. The health threat is even greater if food is handled by the unwashed hands of those leaving a toilet. So the risks are relative. In very few aspects of human life, can one put a 100% guarantee that one will be safe and one's state of health can be assured.

The importance of placing a simple hand washing facility close by the toilet is an essential requirement if person health is to be taken seriously – and it must be. Regular hand washing is an essential component of improved personal hygienic behaviour. A number of low cost hand washing devices can be made in the home from locally available containers and materials and these are described in this book. The danger of handling *Fossa alterna* humus must be considered in relation to other potential contaminants related to the toilet, raw excreta itself being the most obvious.

If there is doubt about the safety of the excavated humus, for immediate transfer to the garden or vegetable bed, it can be transferred to sacks for storage for an additional length of time. Sometimes this method of “bagging” may actually be preferred by the family. In excavating and storing in bags, the material is turned and aerated, and this certainly helps to promote the composting process. This period of “secondary composting” in bags may be preferred because the time of excavating may not necessarily coincide with the time of planting vegetables. Some gardeners may on the other hand prefer to dig in the humus into the bed well before planting. Thus the humus will undergo further processing. The humus will nearly always be mixed with local topsoil before planting.

The nutrient rich humus (see soil tests later in this book) excavated from the fully composted pit is far more fertile than normal topsoil, so by mixing the “eco-humus” with existing topsoil the fertility of the topsoil is greatly improved. This is true for all the major nutrients, nitrogen phosphorus and potassium. Because the volume of eco-humus derived from a family latrine is relatively small (about 0.6 cubic meters per year), most humus derived from the *Fossa alterna* is mixed with soils used in vegetable gardens in the back yard. A 2:1 mix of topsoil and humus is a useful ratio to use on small vegetable beds (see later). A 2:1 or 50/50 mix results in a considerable enhancement of the nutrient value of most top soils, which can lead to significant increase in the production of vegetables (see later). Thus the “close the loop” principle is once again achieved - and this is a central requirement of ecological sanitation. What is eaten goes back into the system.

The *Fossa alterna* was originally designed for use in peri-urban settlements. The total area required for this toilet is quite small - about three square meters. Within this area it is possible to excavate two shallow pits lined wholly or partly with bricks or protected with two ring beams at the head of each pit. Time has shown that the simplest method – using concrete ring beams, is the most effective if the soil is moderately firm. This is because when a ring beam is used, there is maximum exposure of the pit ingredients to the surrounding soil. This improves drainage and also exposes the converting excreta/soil mix to the myriad of organisms present in the soil - and also, interestingly, of plant roots which are found in the topsoil. The conversion of excreta into humus takes place more rapidly in unlined or partially lined pits compared to those that are fully lined with bricks, or concrete rings.

The *Fossa alterna* also has considerable application in the rural areas as well. In Niassa Province, Mozambique (Ned Breslin, WaterAid, Mozambique) and in Thyolo District Malawi (Elias Chimulambe, COMWASH), for instance, the *Fossa alterna* is the preferred option because it offers a simple method of constructing a relatively permanent solution to sanitation. It is also relatively cheap to built, helps reduce flies and odours (even in the absence of a vent) and also provides a yearly supply of humus which can be used in a variety of ways

Much of what has been said in the preceding chapter on the *Arborloo*, applies equally to the *Fossa alterna*. The ring beam, slab and even superstructures can be identical in both units. The shallow pit receives regular additions of soil, wood ash and leaves in addition to excreta in both systems. The addition of garbage to the pit is not recommended in either system, but perhaps a tree will be more forgiving. It is no pleasure to excavate garbage like rags and plastic when the humus is being excavated. The difference is that in the one system the humus is left in place and a tree is planted in it. In the case of the *Fossa alterna* the humus is excavated, thus making available a “new” empty pit which can then be reused and refilled with a new mix of ingredients (urine, faeces, paper, soil, ash, leaves etc) again.

Perhaps the greatest asset of the *Fossa alterna* is its forgiving nature. It is no more than a pit latrine - and very simple to use, with the specific requirement that the users add soil and ash and leaves to the pit regularly, and do not add various other non compostable materials like rags, bottles, rubber, plastic and all manner of other garbage. The system still works if soil alone is added, but the texture and nutrient content of the humus produced is improved if leaves are added too. Also the conversion is far more efficient if humus like fertile soil is added compared to infertile soil or clay. Ash also helps to reduce odour and fly breeding and adds potash to the mix. The addition of dry leaves helps enormously, both as a layer at the base of the pit (two sacks full), and also throughout the filling process and also on closing off the pit. So the way a *Fossa alterna* is used and managed is a little different from the way a normal pit latrine is used and managed. However the differences are not great and should easily be managed by those who are familiar with the pit latrine. And in the world in which we live, this accounts for most.

Digging out pit latrines, though, is not commonly practiced in Africa, or in any part of the world. This is because the process is most offensive in the extreme. Consequently the first time users of the *Fossa alterna* are cautious at first about this part of the management. They will need convincing. The acceptance of this excavation as part of the procedure for using this system may not be immediate. The potential users will need to have seen other *Fossa alterna* pits excavated without difficulty and examined the humus for themselves. After a season of use however they will be convinced. Also they will be more convinced if they have seen evidence that the mixing of the humus with poor local top soils does actually enhanced the growth of vegetables. They will need to be convinced that the system is simple to build and simple to use, and also offers many benefits in addition to the conventional pit toilet. Potential users must be made aware, ahead of time, that for the system to work well, it is important to add soil, ash and leaves to the pit, regularly, and that they must also excavate the humus once a year. Thus projects involving the *Fossa alterna* require an effective component of education and demonstration. It does require more attention and effort than the use of a normal deep pit latrine. Indeed all solutions involving eco-san require much more user participation than the standard pit or flush toilets systems demand.



Inspecting humus taken from the *Fossa alterna* in Mozambique.

There is now much evidence that the pleasant nature and perceived value of the humus, with its ability to enhance soil fertility within the homestead, is encouraging people to excavate at the appropriate time. The excellent project in Niassa, Mozambique, which has studied various aspects of the uptake and use of the *Fossa alterna* has provided much evidence for the popularity of this system (Ned Breslin, WaterAid, Mozambique. See bibliography). A similar pattern of uptake is also seen in Malawi (Steven Sugden, WaterAid, Malawi). These are encouraging signs.

### **HOW THE *FOSSA ALTERNA* WORKS**

There are two shallow pits close to one another and a single slab and superstructure. Both pits are dug and protected from the start. If this is not done, there may be confusion about how the system operates. The *Fossa alterna* concept cannot work with a single pit. If only one pit is dug and protected, by the time the first pit has filled the initial enthusiasm, drive or money for the latrine project might have gone. The message is simple - build the whole unit - with both pits - from the start with the slab and superstructure mounted over one of the pits. The second pit can be filled with leaves and covered with a lid for the first year.

As the first pit is being used it is filled with a combination of materials - not just excreta. These include faeces and urine and also soil, wood ash and leaves. The pit is used as if it was a composting pit filled from the top. The pit is used until it is nearly full, which for a family of up to 6 persons should be about one year or more.

During this first year period, the second (empty) pit may be covered with a wooden lid and left empty for the year. Alternatively it can be used as a “leaf composter” by adding leaves regularly throughout the year interspersed with thin layers of soil. The resulting leaf compost will be of considerable value in the garden. (see nutrient levels in following chapters).



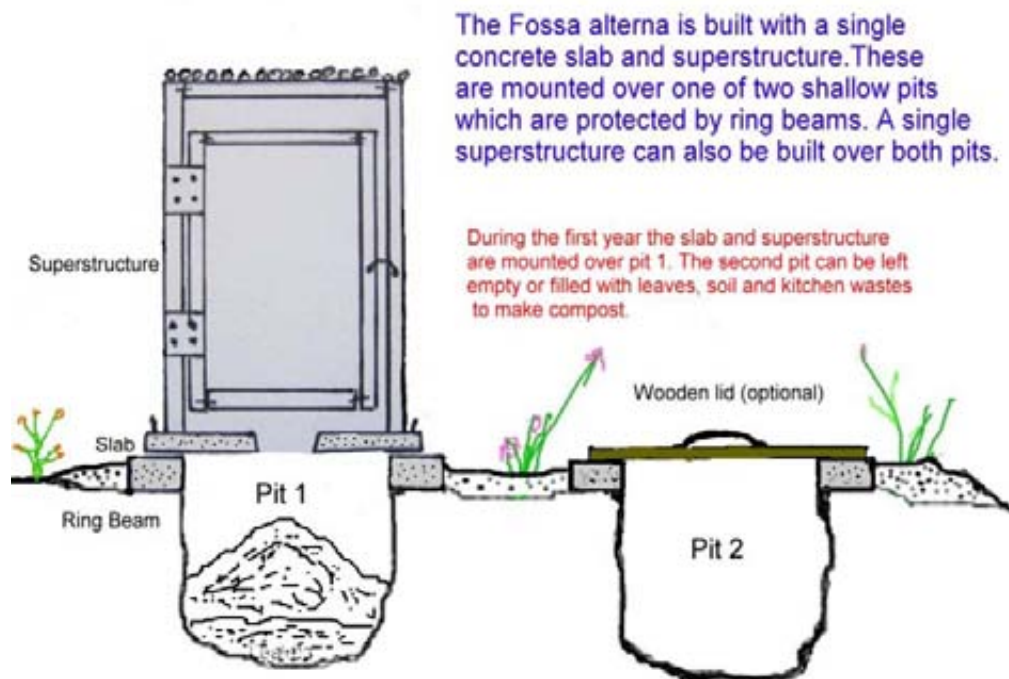

To start, two sacks of leaves are added to the base of the first pit. The slab and superstructure are fitted and the use of the toilet can begin. Buckets of dry soil, ash and leaves are placed inside the toilet. Every day, and preferably after every visit to defecate, some soil is added. Ash should be added too. Periodically leaves are added in addition.

When the pit filling with excreta and other materials is nearly full (after about a year), the slab and superstructure are removed and placed over the second pit which should be empty. If it has been filled with leaves, the leaf compost is removed and used on the garden. Two sacks full of leaves are added to the base of the new pit before it is put to use. The first pit filled with the mix of materials is then “topped up” with leaves and a layer of soil at least 75mm thick and left to form humus over the following 12 months. If there is doubt about the correct proportion of leaves and soil being added to the pit, more soil and leaves can be added and rammed into the pit. The final covering layer of leaves and soil is then added. This process has the effect of increasing the proportion of soil/leaves within the mix and also distributing it more evenly throughout the pit.

During the second year, the second pit will be filling with the mix of excreta, soil, ash and leaves whilst the first pit is composting. At the end of the second year the second pit will have nearly filled. By this time, the contents of the first pit will have already converted into humus which can then be excavated.

The excavated humus can be mixed with topsoil and dug into vegetable beds in preparation for planting (see later). Alternatively the humus can be placed at first in large sacks until the time comes to mix it with topsoil and grow vegetables. The excavated material can also be stored in a heap under the cover of a plastic sheet.

Once the humus has been excavated, the superstructure and slab are then returned to the original pit after more leaves have been added. The filled pit is covered with leaves and soil and the whole process is repeated again. Every year the process is repeated, possibly at the

same time of the year. In Zimbabwe, the best months are during the latter part of the dry season (September – November). The process can in fact take place at any time of the year, but is normally easier to undertake during the dry season. The process will still work if leaves are not added, but the final quality of the humus will be reduced. Leaves add air to the composting mix and improve the efficiency of composting. It is important to add leaves if they are available.

### The Fossa alterna after one year of use

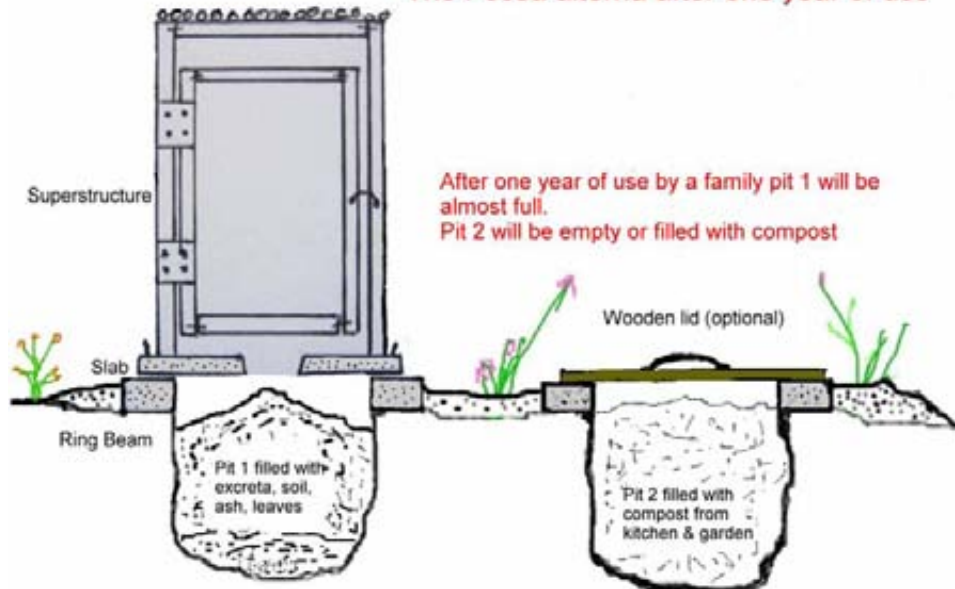

### The Fossa alterna after the second year

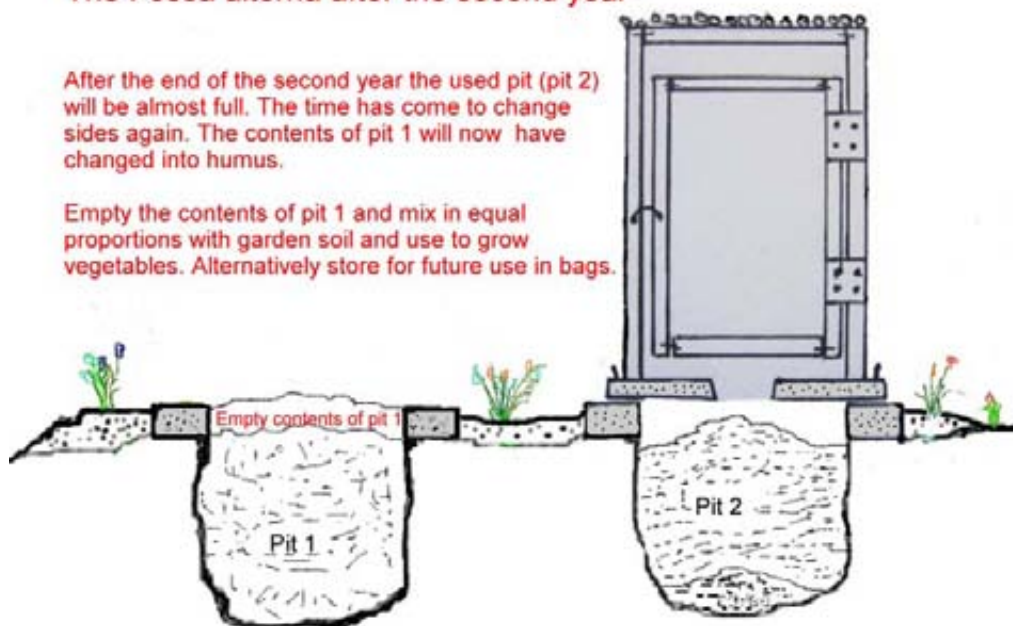

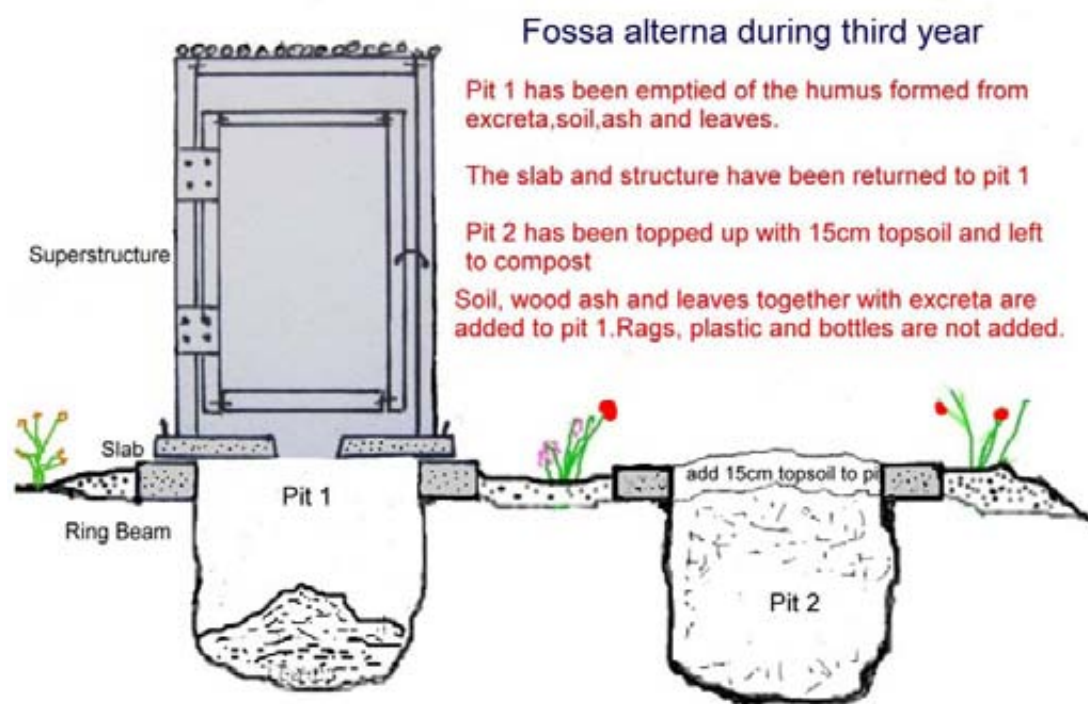

## **The *Fossa alterna* - Stages of construction**

### **Siting the *Fossa alterna***

This will be very similar to siting the *Arborloo*, in terms of access and distance from a well, homestead etc. But there will be no future trees to consider in the siting procedure. In essence the *Fossa alterna* must be sited in the most convenient place for the family. It can be backed on to a fence line. There should be room to move the structure from one pit to the next. Proximity to the vegetable garden may help but is not serious. The most important point in siting is convenience and privacy.

### **Methods of protecting/lining the twin pits.**

Unlike the *Arborloo* the twin pits of the *Fossa alterna* are sited in permanent or semi - permanent locations. That is, they are sited in a place which may not change for some years - although of course it is very easy to re-site the pits at any time if there is space. Such pits may be fully lined with bricks or partly lined with bricks or fitted with ring beams of brick or concrete at the head of the two pits. It is an advantage that the *Fossa alterna* concept is adaptable and can use light and portable structures which impose a much reduced load on the soil around the pit, thus reducing the possibility of pit collapse. If a brick superstructure is used, as in Malawi, then it is essential to line both pits with mortared bricks to the base.

The ring beam method is the simplest and cheapest way of protecting the shallow pit with the *Fossa alterna* and also the most effective in terms of humus formation. So far this method has worked well in Zimbabwe even on moderately sandy soils under experimental conditions. But the experience of time alone will tell. With these types of structure with portable components, if there is any sign of movement, the parts of the latrine can be moved quickly to another site.

The decision as to which type of pit protection to use depends on local soil conditions. In very loose sandy soil, the pit will need lining with bricks to the base. If the soil is firmer a ring beam or part brick lining may be quite adequate, since a portable superstructure is not heavy. In most situations a ring beam will be perfectly adequate. It is also by far the cheapest and simplest method. If there is doubt about soil stability always line the pit with bricks to the base.

## **1. Ring beam method**

### **Concrete ring beams**

The best ring beam method uses a reinforced concrete beam which is strong and permanent. When well made, concrete structures like ring beams and slabs last almost indefinitely. They are a good investment in time and money. This is the recommended version for firm or moderately firm soils. A concrete ring beam can be laid on the surface of the ground in the same way as the ring beam for the *Arborloo* is laid (see previous chapter). If the ring beam is made of bricks, the soil near the head of the pit should be cut back down to about 150mm below the surface and the bricks can be built up from this level to one or two courses above ground level (see later). In both these cases the final pit is dug down within the ring beam to a depth of between 1.2 and 1.5 metres. This will provide an effective full pit volume of about 850 litres with a useable pit volume of approximately 650 litres.

Note here that the twin ring beams of the *Fossa alterna* can be cast in situ (ie in the final position) since they will not be moved. This is the preferred method. With the *Arborloo* the ring beam is best cast in another place and transferred on to site when it has cured. Since the ring beam of the *Arborloo* will be moved every year it must not be bonded too tightly to the soil as it may be difficult to remove at the time of the toilet migration. A tight bonding between ring beam and soil is desirable with the *Fossa alterna*.

The internal measurement for ring beams used with the *Fossa alterna* should be around 1.0m diameter for round ring beams, or about 0.8m square for square ring beams or 0.7 X 1.0m for rectangular ring beams,. These will accept concrete slabs which are 1.2m in diameter, 1.0m square or 0.9m X 1.2m respectively.

### **Making the two concrete ring beams for the *Fossa alterna***

In those examples described here, the external measurements of the beam are 1.3 metres X 1.0 metres, the inner measurements (the size of the hole) being 1m X 0.7m. This ring beam is made for a slab measuring 1.2m X 0.9m. Wire reinforcing is used within the concrete mix, two strands of 3 - 4mm wire down each length, making a total of 8 pieces (total length approx. 9 metres). With the ring beam, the corners are a potential weak point.



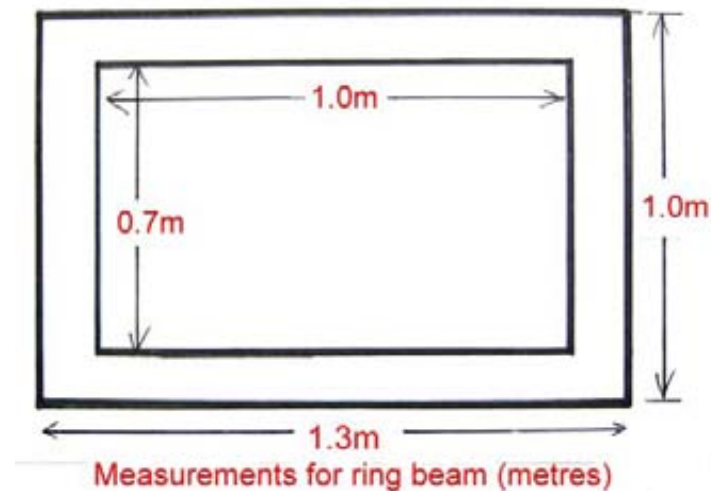

When constructing the *Fossa alterna*, the two ring beams can be cast on the actual toilet site directly on the ground, at least 0.5m apart and preferably at least 1.0m apart. A level piece of ground, preferably on a slightly elevated site is best. Alternatively the two ring beams can be cast away from the toilet site and moved on to site after curing. In this case a plastic sheet should be laid on the ground on which the ring beams can be made. The mould for the ring beam can be made with bricks as shown in the photo. Wooden shuttering can also be used as a mould, or a combination of bricks and wood. The ring beams are made 75mm thick, the thickness of a brick.

One 10 litre bucket of cement (weighing 12 kg) is mixed with five 10 litre buckets of sharp river sand to make each ring beam. If a 5 litre bucket is available the total mixture can be made in two batches. Half the full mixture is made first, that is 5 litres cement (6kg) and 25 litres clean sharp river sand (or if small stones are available, 5 litres cement, 15 litres sand and 10 litres small stones). A 5 litre bucket is useful for measuring, but 10 litre buckets are easier to find. Sufficient water is added to the mixture to make a thick slurry. Do not add too much water. This half mix is added to the lower half of the mould and spread out and tamped down with a wooden float. Then the wire reinforcing is added (4 lengths of 3 - 4mm wire in each direction). This is followed by the second half of the mix. If this square ring beam is used to construct the *Arborloo*, four handles will help with the relocation. The four handles (if required) can be made from 4 steel bars about 8- 10 mm diameter and about 25cm long - four can be made from a one metre length of rod. These are bent and set in the concrete (see photo). No handles are required for the *Fossa alterna* ring beams as they remain permanently in position. The concrete is finally levelled off with a wooden float. The beam is covered with a plastic sheet if possible and allowed to set overnight. It is watered the following morning and kept covered and wet for at least a week before lifting. The longer it is allowed to cure the stronger it will become.



The ring beam shuttering can be made with bricks or wooden planks or a combination of both laid over a plastic sheet. Two ring beams have been cast within brick moulds over plastic sheet. After a few days the bricks can be carefully removed – watering continues. Note the handles inserted into the ring beam at the edges – these are useful if used with the *Arborloo*, but not necessary with the *Fossa alterna*, since the ring beams will never be moved. In practice handles are rarely used on the ring beam!



In the case of the *Fossa alterna* the two ring beams can be cast on the site where they will be used about 0.5m apart. In the case of the *Arborloo*, the ring beam is best made on one side and then placed in position as it will be easier to move later. Once the ring beam has been positioned and made level, the soil inside is excavated to the required depth. This is about one metre for the *Arborloo* and between 1.2 and 1.5m for the *Fossa alterna*. The excavated soil is deposited around the ring beam and rammed hard. This simple procedure will protect the pit in all but the loosest soils. Two bags of leaves are deposited on the floor of the pit before the slab is fitted. The leaves help to start off the composting process.



Here two ring beam for the *Fossa alterna* have been cast on site. On the right a completed *Fossa alterna* mounted on one of two permanently sited ring beams

## **Brick ring beams for the *Fossa alterna***

Ring beams can also be made from bricks which are bonded together with strong cement mortar. These beams can be built around the upper part of the pit. It is wise to start constructing the ring beam from below ground level and build up to one or two courses above ground level. The outer measurements are the same as for the concrete ring beam. However measurements for the both the slab and the ring beam are optional. A brick ring beam may be constructed from between 0.3m (shallow ring beam) to 0.5m (deep ring beam) below ground level. This leaves at least half the pit unlined but in most soils this is quite satisfactory for light weight structures placed over shallow pits.

Partly lined pits offer better drainage potential for the *Fossa alterna* compared to fully lined pits where the area of seepage is reduced to the base area only. There is a chance that this may become plugged if the water table does rise into the pit, or if too much water/urine is added. If the soil conditions allow for good drainage it may be best to fully line the pits. A generous layer of leaves (2 sacks full) added to the base of the pit helps drainage, as well as improving the efficiency of composting.

Deeper ring beams are normally constructed from 0.5 metres below the surface and rise to one or two courses above ground level. They can be made 100mm wide (single brick thickness) or 225mm wide (double single brick thickness) for extra stability.

If the “standard” slab size of 0.9m X 1.2m is used, the outer measurements of the brickwork for the single course should be just over 0.9m X 1.2m so the slab will fit neatly over the ring beam. Allow about 1 -2 cm all round - that is 0.95m X 1.25m for the outer measurements of the brick ring beam. In the case of the double course the outer measurements for the ring beam will be about 1.15m X 1.45m (pit excavation size about 1.2m X 1.5m).

The initial hole should be dug down about 0.5m below ground level - the hole size determined by the thickness of the brick construction (single or double course). The brick wall is build up from the base of this shallow 0.5m deep pit to one or two courses above ground level with strong cement mortar. The uppermost brick layer should be covered with a strong cement mortar for strength and protection. Once the mortar has hardened after a few days, the hole can be deepened to 1.2 – 1.5 metres within the brickwork. Two such partly lined pits are built about one metre apart.

Since concrete slabs will be taken off and placed back on the ring beam/upper pit lining at yearly intervals with the *Fossa alterna*, it is desirable that the working surface of the uppermost concrete/plaster layer be durable. This should be made of high strength mortar or concrete which is well cured. It should be well formed and left to cure under wet conditions under a cover for a week to develop a good strength. Often this final plaster layer is thin and made in weak mortar, just for appearances. The brick work of this vital working layer may fall apart when put to use if not properly made.

## **Arrangement of brick ring beams for the *Fossa alterna* with permanent structure**

In Mozambique the slabs and pits are square and the brick ring beams are also made square and built up about four courses, three below ground level and one above. There is a little variation depending on the type of soil. In Mozambique, as in Malawi, the two shallow pits, which are dug up to 1.5m deep are “housed” within a single, permanently placed, non



movable superstructure, made of grass and poles in Mozambique, and often bricks in Malawi (see later). In these cases the ring beams are built about 0.5m apart to conserve space.

### Examples of brick ring beams for the *Fossa alterna*



Prototype *Fossa alterna* being built at Woodhall Road. Each ring beam was constructed with three courses of cement mortared brickwork. The two pits were only 0.3m apart. This distance was later increased to 1m. The experimental prototype had a shallow pit only 0.6m deep. Later pits are dug over 1m deep, and normally at 1.2metres. 1.5 metres is a maximum depth for the *Fossa alterna*.



*Fossa alterna* ring beams being constructed in Lilongwe, Malawi. Here the soil is firm. In this case the pit is first dug down to about one metre. The upper end has then been widened to allow for the 2 course brick ring beam to be constructed from one brick course below ground level. Two brick courses have been built above ground level. Soil taken from the pits is then built up around the two ring beams. This raises the site of the toilet above the surroundings, which helps divert rainwater from the site.



On the left two brick ring beams have been built for a *Fossa alterna* in Lichinga, Niassa Province Mozambique. On the right two brick ring beams have been built in Kusa, near Kisumu, Kenya. The ring beams are permanently sited and are best bonded with strong cement mortar.





Brick ring beams for the *Fossa alterna* at the Friend Foundation in Harare. On the left three ring beams have been built in a line. This communal unit is heavily used and in order to attain the one year composting period, three pits, each one metre deep have been built. The slab and structure rotate between the three pits. On the right the brick ring beam is shown. It has been built with four courses of bricks. The pit is first dug down 0.5m and about 1.3m X 1m wide. The brick beam is then built up to one course above ground level. The brick mortar is allowed a day or two to cure and then the pit is dug down deeper to the required depth (1m – 1.5m). Note the layer of strong cement mortar covering the upper surface of the brickwork. This mortar is also extended outside the beam above ground level. This makes a strong and durable ring beam unit for the *Fossa alterna*. It is intended to last for many years.

### Fully brick lined pits for *Fossa alterna*

These are required for the *Fossa alterna* if the soil is very loose. A full brick lining is used in all cases where a brick superstructure is built. Fired bricks and cement mortar should always be used underground. The brick lining is built up to at least one course above ground level. Always use cement mortar for bonding and fired bricks. When pits are lined from top to bottom with cement mortared bricks, it is only the bottom surface which allows for drainage. In clay soils the drainage will be poor and not entirely suitable for the *Fossa alterna*. The brick lining is built up to at least one course above ground level. The bottom should be cleaned of cement and a very generous later of leaves placed in the pit before use.



A fully brick lined *Fossa alterna* pit in Epworth close to Harare. The pit was 1.1metres deep. The soil is sandy and less stable. On the left the base of the pit is being cleared of cement mortar dropped during the brick work stage. On the right a layer of weak cement mortar is applied on the brick ring beam before the toilet slab is mounted on the ring beam. This weak mortar forms a good air tight base on which the slab can sit. This is important as it makes a good foundation for the slab and also an airtight seal for the best functioning of the vent pipe(when fitted), which draws air through the system, reduced pit humidity and also controls flies and odours. The ring beams in this case are about one metre apart.



On the left a permanent brick *Fossa alterna* structure is built around two brick lined pits in Thyolo, Malawi (COMWASH Project). The brick lined pits are shown on the right.

### Proximity of twin pits/vaults

In the first prototype *Fossa alterna*, built in June 1999, the two pits were placed side by side only 300mm apart. These pits were protected with brick ring beams. By placing the pits slightly apart the possibilities of seepage of digesting excreta from one pit to the other were reduced. If some space is available it is best to place the twin pits one metre apart to avoid any contamination passing from one pit the other. If space is really restricted 0.5m is adequate. The pits can be dug close together for convenience of movement of the superstructures, but far enough apart to reduce the potential of one pit being influenced by the other in terms of leakage of contents. Thus two separate pits, dug about one metre apart is recommended. If the two pits are located within a non portable structure, as is the case in Mozambique and Malawi, then the pits cannot be far apart. Normally 0.5m is adequate.

### Making square or rectangular concrete slabs

These slabs are made with either a 3:2:1 mix of river sand, small stone, and cement or a 5:1 mix of clean river sand and cement. They use the same amount of materials as the concrete ring beam described earlier – that is one quarter 50 kg bag of cement. If small stones are available, then this will be stronger, but usually small stones are not available so river sand alone must be used. The river sand should be clean and sharp, with little dust and small chips included. As with the ring beam, half the mix is made up first and added to the mould and levelled off. The wire reinforcing is now added (same as ring beam – 4 pieces of 3 - 4mm wire in each direction). The final half of the mix is now added, levelled and finished off with a steel float. Four handles should then be added.

The concrete slab described here is 0.9m wide and 1.2m long and about 40mm thick. The mould in which the slab is cast can be made with bricks or wooden planks or a combination as shown in the photos below. Most slabs are made with squat holes as this is the preferred position, but slabs can also be prepared for fitting a pedestal. In the case of the squat hole a suitable hole can be made by taking a 20 litre bucket, cutting off the bottom and bringing together the base into a pear shape with wire. A squat hole size of about 30cm X 19cm is

required. If a pedestal is fitted the hole is 30 cm across and can be formed by a plastic basin. A hole can be made for a vent pipe also in the slab. This is made by inserting a short length of pipe (75mm long) in the slab at the appropriate position (see diagrams). The vent hole size should match the pipe which will normally have a diameter of 110mm. It is possible to make a low cost home made vent pipe using hessian and cement.

One 10 litre bucket of cement (weighing 12 kg) is mixed with five 10 litre buckets of sharp river sand to make each slab. If a 5 litre bucket is available the total mixture can be made in two batches. Half the full mixture is made first. That is 5 litres cement (6kg), 15 litres sand and 10 litres small stones (or 5 litres cement and 25 litres clean sharp river sand). A 5 litre bucket is useful for measuring, but 10 litre buckets are easier to find. Sufficient water is added to the mixture to make a thick slurry. Do not add too much water. This half mix is added to the lower half of the mould and spread out and tamped down with a wooden float. Then the wire reinforcing is added (4 lengths of 3 - 4mm wire in each direction). This is followed by the second half of the mix. The four handles can be made from 4 steel bars about 8- 10 mm diameter and about 25cm long - four can be made from a one metre length of rod. These are bent and set in the concrete (see photo). The concrete is levelled off with a wooden float and finished off with a steel float to make smooth. The slab is covered with a plastic sheet if possible and allowed to set overnight. It is then watered the following morning and kept covered and wet for at least a week before lifting. The longer it is allowed to cure the stronger it will become. 10 days is even better.

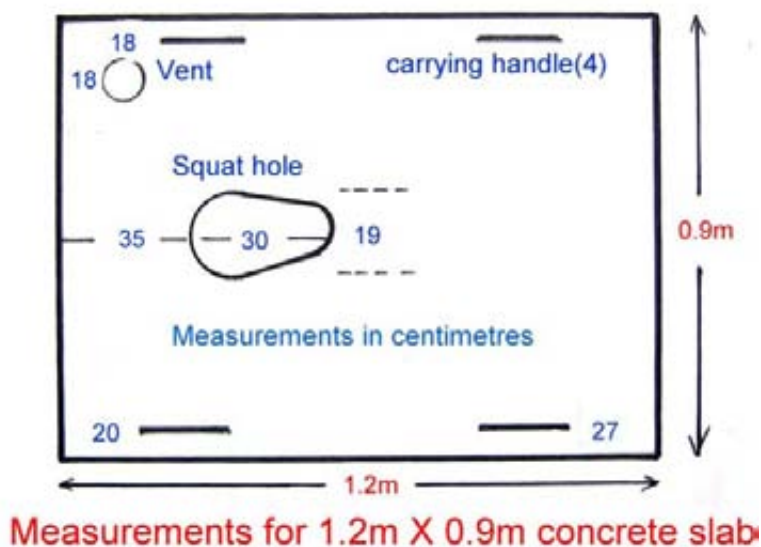

Where generous quantities of soil and wood ash are added regularly to the pit contents, there may be little need to fit a vent pipe, as these additions greatly help to reduce fly and odour nuisance. But the vent does help to reduce any odours that are present and controls flies as well if the required volume of ash and soil is not added. Vents also carry away excess moisture from the pit, which will almost certainly help the composting process. They also ensure that a fresh supply of air is being circulated through the pit, which will also help composting. Because the slabs of both the *Arborloo* and *Fossa alterna* will be moved at approximately one year intervals, it helps greatly to fit four carrying handles to the slab. These can be made by cutting 4 lengths of 8 - 10mm steel rod each about 25cm long and bending them and inserting in the fresh concrete towards the edges. The concrete is levelled off with a wooden trowel and finally smoothed down with a steel float. Once the concrete has begun to harden, the moulds for the squat or pedestal holes and the vent pipe hole can be carefully removed. The slab should be covered with plastic sheet if possible and left for a week to cure.



During this period it should be kept wet continuously. If plastic is not available it can be covered with sand which is kept wet. For all concrete work, good curing is essential.



**Photo of slab mould made of bricks and wooden shuttering. The eight pieces of 3mm reinforcing wire have been cut and laid on the plastic ground sheet. Four carrying handles have also been prepared. A 10 litre bucket with the base removed has been shaped by drawing in the two sides with wire. A 75mm length of 110mm pipe has also been cut to make the hole for the vent pipe. Thus all has been prepared for the addition of the concrete.**



**The addition of concrete is complete. Half the mix is added first, the reinforcing wire is laid, followed by the remaining concrete which is smoothed down. The handles are added by pushing them into the concrete mix. A little extra cement can be added around each handle to increase the strength of the concrete at this point. Finally the slab is smoothed down flat with a steel float and left to cure.**

In many latrines, the slope of the slab is made so that washing water will flow into the squat hole. However if no roof is fitted to the structure the slab will act as a rainwater harvester and water will collect in the pit, which is undesirable. It will be remembered that for the natural breakdown of excreta into humus suitable for tree growth, the pit contents should not be too wet, but should be moist. It is undesirable therefore to have too much water entering the pit. One option is to make the slab flat or to slightly raise the central area around the squat hole including the foot rest area. In this case most drainage water from the slab will flow onto the ground around the slab. This might undermine the ring beam or pit head during the rains. However since the slab will move from one pit to the next, undermining of the ring beam within in a season may be unlikely. The simplest method is to make the slab flat – most rainwater will run away from the squat hole. The ideal is to fit the toilet structure with a roof.



## Preparing the pit before use

Before the slab is fitted it is a very good idea to add two sacks full of dried leaves to the base of the pit. This will help the composting process from the moment fresh excreta is added. This composting process will take longer if the excreta falls on barren soil at the base of the pit.



Adding dry leaves to the base of a pit helps the composting process. A full sack full or even two sacks full works well. The pit is ready – ring beam in place and leaves at bottom.

## Adding the concrete slab

The concrete slab is now mounted on top of the ring beam. It is wise to bed down the slab on the beam in a layer of very weak cement mortar (20 parts pit sand + 1 part cement). This makes the slab firm and stable. If a vent is fitted to the system it is very wise to seal any gap between the beam and the slab. This will improve venting of the pit and fly control. If there is a gap between the slab and the ring beam, odours may be released and this attracts flies. Also the efficiency of venting is reduced. A very weak mix of sand and cement can be used as a sealer (20:1) or soil cement or termite mortar. If cement is not available at the time, termite mortar could be used. The slab is now fitted centrally over the ring beam.



Adding a layer of weak cement mortar for the slab to rest on. This helps the slab to rest on the ring beam without strain. Also if a vent pipe is used, the pit should be air tight, thus allowing the suction of the pipe to draw air down the squat hole or pedestal. This leads to odourless conditions in the toilet. On the right a slab is mounted over the ring beam. This slab has a larger hole intended for a pedestal cast in it.



Adding dry leaves to the base of the pit in Epworth



The concrete slab is bedded into a layer of weak cement mortar on the ring beam. The photo on the left shows one being fitted at Epworth. The photo on the right shows the prototype fitted in Woodhall Road. Carrying handles are useful when moving the slab from one pit to the other

## Superstructures for the *Fossa alterna*

### Fitting the superstructure (with optional vent pipe and pedestal).

A great variety of superstructure designs are suitable for the *Fossa alterna*. The main purpose of the structure is to provide privacy – the functioning of the *Fossa alterna* is not much influenced by how the structure is made. However a roof is very desirable, as this helps to control flies and helps to keep rain out of the pit. Very wet pits do not compost well. The various photos in this chapter and the previous chapter on the *Arborloo* show the great variation in superstructure design. Not all *Fossa alternae* are built with a single portable superstructure however. Most of those in Mozambique built under the WaterAid and ESTAMOS programmes, and also in Malawi under the WaterAid, CCAP and COMWASH programmes use a single larger permanent superstructure which surrounds and is built around both pits. The WaterAid funded work on promoting ecological sanitation in Mozambique and Malawi has been very successful. The *Fossa alterna* concept has become very popular because the regular addition of meaningful quantities of soil and ash to the pit have noticeably reduced fly and smell nuisance. The permanent location of the twin pits is attractive to the users since it seems to offer a longer term solution to their sanitary problems. Equally as important is the realisation that within a year, excellent humus can be extracted easily from the shallow pits (up to 1.5m depth). The value of this humus when applied to vegetable gardens is thought to be considerable. All these features make sense to the users. For once the toilet has a value of its own, apart from the disposal of excreta. The *Fossa alterna*, like the *Arborloo*, may have come at a time when the sanitation world is in need of a new approach.



## Examples of *Fossa alterna* superstructures



On the left the prototype *Fossa alterna* used a wooden structure and two shallow pits with brick ring beams. On the right a *Fossa alterna* in a low density suburb in Harare. This unit used two concrete ring beams, a structure made with a steel frame overlaid by grass and a 75mm PVC vent pipe.



*Fossa alterna* at Woodhall Road, Harare. Note hand washing facility, waste water falling into a flower pot. Second pit during the first year was filled with leaves and compost. It was also used to grow comfrey (see later). Inside a home made pedestal has been fitted. The yellow bucket contains a mix of soil and wood ash and a dispenser. Leaves are also added occasionally.



Fitting the portable superstructure to one of the twin *Fossa alterna* pits in Epworth, close to Harare. During the first year the second pit was filled with leaves and thin layers of soil to make leaf mould. After 12 months the leaf mould was dug out and the slab and structure moved to the second pit (as shown). The pit filled with excreta, soil, ash and leaves has been topped up with soil (see right of picture).



*Fossa alterna* in Niassa Province, Mozambique built under the WaterAid funded programme. The twin pits are enclosed in a single pole and grass superstructure which is permanently located. A washing area is also constructed as part of the system. These are very popular units, as they are almost odour and fly free, unlike many earlier toilets built in the area. They are also relatively low cost. The pits are each 1.5 metres deep and protected by brick ring beams. Here one of the pits is being excavated for humus.



On the left a *Fossa alterna* with portable structure being constructed in Kusa Village, Kisumu, Kenya. On the right a permanent brick and thatch *Fossa alterna* built at Kufunda Village, Ruwa, Zimbabwe



# Management of the *Fossa alterna*

## 1. Daily management

### **Add soil, wood ash and leaves regularly**

Two sacks of dry leaves are added to the pit base before use. Then the *Fossa alterna* is used much like a normal pit latrine. Urine, faeces, and anal cleansing material, preferably paper are added every day. In addition and in order to build up the mix of ingredients which assist in the conversion of faeces into humus, it is important to regularly add dry topsoil and wood ash to the pit, preferably after every visit made, and also leaves from time to time. At the very least a small cup full of the soil should be added after every visit made to the deposited faeces. It is unnecessary to add the extra ingredients after urination only - this may result in the pit filling up too quickly with soil. If this soil is mixed with ash the resulting mixture will improve, as it will be slightly more alkaline and some potash will be added. Wood ash also helps to reduce odour and flies. The final texture of the humus formed in the pit will be improved greatly if leaves are also added regularly. At least a sack full should be added before the pit is put to use. These compact a great deal and the volume of leaves added should be generous. The leaves may have a considerable nutrient value of their own, as described for leaf compost in the gardening chapter. So they will improve not only the texture, but the overall nutrient value of the final humus. The final quality and usefulness of the humus will also be improved by the addition of organic vegetable matter from the kitchen like fruit skins and vegetable peelings. This will increase the volume of added materials and a balance must be struck between volume added and final quality of the humus. The more soil and vegetable matter (like leaves and vegetable/fruit cuttings, the more crumbly and valuable the produce will be in agriculture.

Ideally a premix of soil and wood ash can be made in the dry state and stored for use in bags. Such a mix is best prepared in the dry season. Dry leaves, even when crushed, do not mix well with soil as the heavier soil tends to fall deeper into the mix with the lighter leaves being concentrated on top. Hence the leaves must be added separately to the pit – taken from a separate container, like a sack, within the latrine. The dry soil and wood ash can be mixed beforehand - mixing 4 parts of dry soil to one part of wood ash. This is best mixed in bulk, stored in a larger container or sack and then brought to the latrine in smaller lots. Similarly the dried leaves are stored in bags and also brought into the latrine in smaller lots. The leaves once dry can be crushed to reduce their volume before storing in bags. They can be crushed by treading, by beating with a stick or rake, so that the leaves break down in to smaller units. The volume of dry leaves can be reduced considerably in this way and make for more efficient storage. The leaves will compact a great deal once in the pit and the soil will provide microbes which greatly assist the conversion of the excreta.

### **Pit filling rates**

A little mathematics is required here. The volume of soil and ash added to the pit should be thought out beforehand and a suitable container such as a mug, or the upper part of a plastic milk bottle, with handle attached used for dispensing the soil/ash mix. If a family of 6 persons defecates once a day each into a pit and adds soil/ash after each deposit is made, it is possible to roughly calculate the resulting volume of soil. In a pit of cross section 0.7 X 1m X 1.2 m deep the volume to the top is 0.84 cu.m. or about 850 litres. The actual available space may be slightly less, since the upper part of the pit will not be used. If each member deposits 0.2 litres of soil/ash per day that means that approximately 1.2 litres of soil/ash will be deposited each

day into the pit. That amounts to 450 litres of soil/ash per year. The leaves (about a hand full) should also be added, but once composted they will occupy a very small volume indeed - but they will be absorbed into the soil to improve its texture and also add more nutrients. The initial volume of faeces added by the family of six to the pit will be at least equal to this volume if not more - say 600 litres. That is 100 litres per person per year. But about 80% of this initial volume is water. After composting and absorption into the soil, the resulting solid fraction of faeces from a small family may amount to about 250 - 300 litres per year. A much greater volume of urine will be deposited in the pit. Some of this will be absorbed into the pit soil and leaves and later into the resulting humus, but much will seep away into the surrounding ground. This loss of potential nutrients from the urine, particularly nitrogen, must be accepted in shallow pit systems of sanitation like the *Fossa alterna*. That is unless the excellent practice of storing urine, by urinating into containers is also carried out by the family (see chapter on urine). Such storage of urine is highly recommended. In the *Arborloo* not all the nutrients available in the urine are lost from the “loop” as they are absorbed into the surrounding soil and will later be taken up by the tree which is planted on the pit. The accumulation of the stable phosphorus in these shallow pits is particularly valuable.

Thus the combined annual volume of ingredients added to the pit may approximate 450 litres soil/ash/leaves plus a processed volume of faeces amounting to 250 - 300 litres, plus urine which will be absorbed into the humus and leaves or drain into surrounding soil. Thus an annual total of approximately 700 – 750 litres of humus can be expected. In practice a 1.2 metre deep pit will fill up in about one year for an average family. A 1.5 metre deep pits provides more latitude and should be aimed for.

It is accepted that in the real world such additions may not follow these recommendations exactly. In practice the soil may be added less frequently, resulting in a lower proportion of soil to excreta. The concept will still work quite well if soil alone is added without ash, but will not work so well if wood ash alone is added. The combination of human excreta and “any” soil will make a “new” soil which is greatly enhanced in terms of nutrients. The addition of a humus-like topsoil makes a better product than poor sandy or barren or clay like soil. Leaves provide extra nutrients, but equally as important they improve the texture of the final product considerably and also allow more air into the mass which helps the composting process. Also urine combines well with leaves to make compost. So the best is fertile topsoil, wood ash and leaves in combination. This combination will turn into excellent humus.

However the easiest way may be the only way at first - and this will be to use the soil which has been excavated from the pits or surrounding topsoil, whatever is available. Such soil may be very poor - both in texture and in nutrient content, but remarkably, once combined with excreta, the nutrient levels of the soil rises significantly (see chapter on soil tests).

### **Sources of fertile soil and compost in the garden**

Sources of fertile soil can be found in most gardens to add to the used pit and also to add on top of the leaves which are added to the second pit. A good place to look for fertile soil is under trees where leaves may have fallen and begun to make “leaf compost.” Leaf compost is the final product of decomposed leaves. Look around the garden for places where compost may have been made before and vegetables grown. Often the soil is barren in dry areas. Therefore the search for fertile soil will be more difficult. It is always a good idea to start making a compost heap to enrich the garden soil for planting vegetables. Sometimes it may be necessary to import some compost or fertile soil (on a Scotch cart for instance) from some

other place where the soil is more fertile. Once the *Fossa alterna* is working properly, a yearly supply of humus for the garden will be available within the homestead from the composted pits. It is worth making the effort in the early years. The greater the proportion of these compostable materials added to the pit, the better will be the final humus excavated.

### **Finding fertile soil or leaf litter in barren environment**

The question will be asked: where do we find fertile soil in a barren environment? The answer lies in looking under trees where humus may have been accumulating - or even going farther a field to find it and bring it back to the homestead in bags. Leaves may accumulate in pockets or depressions and may have partly converted into leaf mould over the seasons. The search for a living soil will often come up with something. The best soil which is available should be used first time around. Second time around the humus excavated from the first pit can be added to the second pit which will now be filling

### **No garbage please!**

Since the humus will eventually be dug out, it is doubly important to ensure that garbage (rags, plastic, bottles, wire, glass, rubber, etc) is not tossed down into the pit. Such garbage can make later excavation tedious, difficult, unpleasant and even embarrassing. Thus plastic, rags, bottles and various other non compostable items should be disposed of elsewhere, like shallow garbage pits. They should NOT be placed down the *Fossa alterna* pit.

### **Not too much water either!**

The conversion of excreta into humus will not take place if the pit is flooded with water. This means that only limited amounts of water should be added to the pit. Good pit drainage very much dependent on soil type and area of soil in the pit available for drainage. Where the ring beam method of pit protection is used a large surface area of soil will be available for pit drainage. Where the walls of shallow pits are lined with bricks to the base - only the base will be available for drainage. There will be a lot of variation depending on soil type, pit volume, pit protection type and the material content of the pit. But it is wise to add some water to the pit from time to time to keep the content moist. It is an excess of water that is not required. So eco-latrines should not be used as bathrooms.

### **Take a look from time to time!**

For the best results, it pays for the user to look down the pit from time to time. One feature of adding soil and ash into the pits of eco-toilets, which is rarely mentioned, is the formation of mounds of excreta rising directly beneath the pedestal/squat hole. This is the result of adding dry soil/ash to the excreta directly after defecation. A piling results, which can look like an ant turret - it can be called "turreting." When this happens, any soil or ash added tends to fall to the sides of the turret and the best mix of excreta/soil/ash cannot result. Thus it is advisable from time to time for the user to take a stick or pole and try to level off the pit contents so that more of the available pit space can be used. Normally this involves moving the pile forwards towards the "front end" of the pit to level out the pit contents. This will help to some extent to mix the ingredients and assist the conversion process. This is very desirable in the *Fossa alterna* so that the greater part of the pit can be occupied with excreta/soil mix - and pit life can be extended. This means "spreading the load" a bit. The family should aim to fill the pit up in a year or more, and not less than a year. Thus the spreading out of the pit contents is an important part of routine *Fossa alterna* management.



### **Adding more soil and leaves to pit contents.**

The routine of adding soil and ash after every visit, and preferably leaves as well, is important. This will help the conversion process. The soil mix is best stored in bags and then placed within the toilet in smaller containers for daily use.

The ratio of soil/leaves to excreta is increased by adding of leaves to the base of the pit before the concrete slab is fitted. This layer helps start off the composting process. It may also help to add an additional 30 litre bag of leaves to the pit half way through its one year cycle. Thus a good layer of “living soil” can begin to act on the raw excreta during the filling stage. Once the pit is filled and the slab and structure moved over, the final layer of leaves followed by fertile soil is added to cover the excreta. Once again the process is helped along if extra soil is rammed into the pit contents. A good layer of leaves followed by topsoil should be left on top of the pit contents and even these can be covered with leaves again. The overall aim is to get as much living soil and leaves into the pit mix as possible to help the conversion.

### **Effects of venting**

The dry soil, wood ash and leaves do help to remove excess moisture from the excreta and this is desirable, since the conversion of excreta into humus will not take place in wet conditions. The addition of a vent pipe also helps to circulate air through the latrine system and also assists in the removal of excess moisture and condensation from the pit chamber. Vent pipes help to remove odour and if fitted with a corrosion resistant fly screen, reduce fly nuisance as well. However the production of humus will not take place in very dry conditions either. Toilet paper and leaves for instance will remain little changed in a very dry vault. The composting process needs some moisture, just as a compost heap requires moisture. So washing down with water will help from time to time.

### **Management of the second pit in the *Fossa alterna***

It is essential to dig and protect both *Fossa alterna* pits during the initial building stage. Whilst the second (and as yet unused) pit can be left empty and covered with wooden lid, it can also be used to the best advantage, whilst the first pit is filling.

The second pit can be used to make leaf compost by the addition of leaves, interspersed by thin layers of soil which is watered regularly. Since ecological sanitation concerns recycling in all its aspects and the development of a recycling habit within the homestead, it makes good sense for the concept of “pit composting” to be introduced. The aim is to develop the interest of composting as a sound gardening practice in combination with the use and management of the eco-toilet. The *Fossa alterna* system makes this possible. Even adding leaves and some local soil to the second pit during the first year of operation can be very valuable. The leaf compost formed in a second a pit in Epworth near to Harare was considerably more fertile than the surrounding soil and proved to be valuable in growing vegetables and maize. At times of heavy rain it is best to cover a composting pit to avoid flooding. If the second pit is not used for growing plants like vegetables or comfrey, it should be covered with a wooden lid.



On left, comfrey being grown on second pit of *Fossa alterna* during the first year. Comfrey is rich in potassium and makes an excellent mulch for vegetables, especially tomatoes. On right leaf compost being made in the pit – a mix of leaves and a little soil – should be kept moist.

## Time to change sides!

### “Changing pits” on the *Fossa alterna*

Once the used *Fossa alterna* pit is nearly full the time has come to change pits. For a family this should be after one year or more. If the latrine is heavily used, and the pit filling time is less than 12 months, it is best to make an additional ring beam and use 3 pits which are filled in rotation. If the pits are used more heavily 4 pits may be necessary. The time of conversion of excreta into humus is dependent on several factors which include moisture content, temperature, mixture within the pit etc - the more topsoil and leaves the better. The pit must not be flooded, neither should it be very dry. Temperature will depend on altitude and season. In warm/hot areas under the right conditions, humus can be formed in a few months. The higher the ratio of soil/ash/leaves in the pit the more effective the conversion will be. Also the more varied the ingredients - the higher the fertility of the humus will be.

If the second pit has been filled with leaf compost during the past year, this should be emptied - thus making available the empty pit. The excavated compost can be used on the garden, but it is also usefully added to top up the pit filled with excreta and soil etc. The same material can be used to add to the new pit as it fills up.

Changing sides involves first remove the superstructure and slab and placing these to one side. Add plenty of leaves into the empty pit. Now place the slab on the ring beam above the empty pit and also seal this off with a weak cement mortar or termite mortar. Now add the superstructure back on the slab (and any pedestal if used). The procedure for latrine management is now started on the second pit, just as before.

### Dealing with the pit filled with excreta etc.

The pit filled with excreta/soil/ash/leaves etc is now levelled off and fertile soil is added. The best results are obtained if extra soil and leaves can be rammed into the body of the pit with a gum pole. This ensures that more soil and leaves are added and well distributed. This may appear to be a most unpleasant task at first. But it pays off. In any event, even if new soil is added just to cover the existing pit contents, this will break down within the year. A layer of about 100mm - 150mm is best. The soil is best fertile and can be taken from the compost pit or from a layer of good topsoil if available. A final layer of leaves can also be added as a leaf

mulch. The pit is watered a little to make the contents moist. The pit can now be left to convert for one year. Occasional watering is required, even if plants are not added to keep the contents moist. The pit must never be flooded.

### **Excavation of the humus**

After one year of composting the pit humus can be removed. The pit contents will have considerably shrunk after one year, perhaps to about two thirds of the volume, as the water content of the faeces is absorbed by the soil and into the walls and floor of the pit. Normally this pit humus is easy to excavate and usually much easier to remove than the original soil when the pit was first dug. A shovel and pick are used. The pick can be used to loosen up the humus, especially nearer the bottom. The humus should be quite dark in colour, but the colour and texture of the humus depending on what has been added to the pit.

The humus removed from the *Fossa alterna* pit is best stored in bags at first, where it will get more time to compost further. It can also be dug into the garden soil, also in preparation for planting. The process of biological breakdown will continue. It can also be mixed with local topsoil and placed in containers or shallow trenches for growing vegetables. These methods are described in another chapter. As with all gardening practice, it is wise to wash hands after doing the gardening and handling compost or the humus from these shallow pits.

After the pit has been excavated and the humus stored in bags etc, two sacks of dry leaves are added to the base of the pit and the process is repeated. The slab and structure are moved onto the empty pit. The pit filled with of excreta, soil, ash and leaves is topped up with soil and leaves and allowed to compost for another year.

This same process is undertaken once a year, every year. Excavating a shallow pit does not take long (about 30 – 45 minutes) and if the right ingredients have been added through the year the process should be easy and not offensive in any way. It is quite remarkable how the foul human excreta can change into a pleasant material. It will change into humus if there is enough soil, ash and leaves in the mix to help the process along. Seeing it for the first time most people are very surprised to see this miraculous conversion of Nature.



**Ephraim Chimbunde excavates humus from a *Fossa alterna* pit in Hatcliffe, a project of Mvuramanzi Trust. The humus, or compost, as it is often referred, to is placed in bags for storage and later transported to the vegetable garden of choice.**



## Variants of the *Fossa alterna*

A number of experimental variants of the *Fossa alterna* have been designed and studied in Harare. These include two fully brick lined double vault units, one which operates under a slab which slides on a rail, the other built with a brick superstructure.

### The double vault substructure with sliding slab

In this case the two fully brick lined pits are built as one unit, one third below the ground, two thirds above the ground. The convenience is that space is conserved, and most of the vault space lies above ground, which may be useful in high water table areas. The upper brick rim of the double vault was fitted with a steel “runner” on which the slab can be pulled from one pit to the other (the slab is cast in a steel frame). In this case the slab and structure can be pulled from one pit to the other without removing either.



The “sliding slab” *Fossa alterna*. Most of the double vault is above ground. A steel rail made of angle iron is cement bonded to the upper rim of the vault. The slab is also cast in a frame of angle iron. The slab runs inside the steel rail. The superstructure is mounted on the slab. A rope attached to a steel handle cast in the side of the slab is pulled and the slab can be moved from one pit to the other. It is an elaborate way of moving the structure, but it works. A little grease helps to lubricate the rails.

### An “above the ground unit”



In this design the vault is built almost entirely above ground with a single course of brickwork below ground level. This unit was built in an area which can experience a high water table during the rains. It can alternate with a concrete ring beam placed at ground level.

## The “long cycle” *Fossa alterna* (alternating compost VIP toilet)

In the *Fossa alterna* unit so far described the period of alternating is about 12 months. The pit is relatively shallow (max 1.5 metres) which has several advantages. These advantages include ease of digging, reduced compaction, better composting, more distant from water table etc. However it is also possible to build shallow pit toilet of this type where the pit is wider or deeper (max about 2 metres) so the period of alternating can be extended to between 2 and 5 years. Composting is encouraged as before by the regular addition of soil, ash and leaves. Experimentation with this method is being conducted in Zimbabwe (Harare) and South Africa (Maputaland). When fitted with a vent pipe, this can be considered a variant of the VIP toilet.

Where the alternating period is longer, recyclable superstructures made of brick can be used. These are best linked to a steel frame fitted with “sprags” which are bonded into the brickwork. Such frames can be fitted with standard doors and hinges, but may be more durable if fitted with hinges made with car tyres. Also the option of fitting lighter doors mounted on the door frame (such as thinner wooden plywood or sacking material) is possible. In this case the bricks are mortared together with a weak cement mortar (20 parts pit sand to 1 part cement). Experience has shown that such brickwork can hold firmly for years, but is also easy to take apart and rebuild. Roofs and vent pipes are best built in materials which will last for a very long time and can cope with being dismantled and reconstructed. The ideal is asbestos. Asbestos vent pipes last much longer than PVC pipes. With good bricks and asbestos roofing and vent, a brick superstructure can be recycled periodically for many years.

The pit size can be increased partly by digging deeper. But since the composting process is still being encouraged, this should not be too deep. 2.0m may be a good depth. Pit volume can be increased by enlarging the cross section of the pit from 0.7 sq.m. (in the model described earlier) to 1.2 sq.m. A pit with an upper cross section of 1.2 sq.m. and a depth of 2m will have a total volume of 2.4 cu.m. This is nearly three times the capacity of a pit with a cross section of 0.7sq.m and a depth of 1.2m (0.84 cu.m.). The larger ring beam (external measurements 1.2m X 1.4m and internal measurements 1m X 1.2m) will require a larger and heavier slab. This will have dimensions of 1.2m X 1.4m and will be 1.5 times as heavy again as the smaller slab(1.2 X 0.9m) and will use 1.5 times the volume of cement and sand to make (15 litres cement + 75 litres river sand).

Once again the type of superstructure mounted over one of the two pits is optional. But where the recycling time is longer, bricks can become a serious option. Where the steel frame version with sprags is used, the entire structure can be taken apart, bricks cleaned, slab relocated and structure completely rebuilt within 6 hours by an artisan. This relatively easy process is possible because the entire brickwork is mounted on the slab itself and no separate foundations are required. The brickwork for this system is built on edge, to reduce weight and the number of bricks required.

It is desirable to dig and line both 2m pits at the same time, using one immediately and retaining the other for future use. The second, as yet unused pit can be filled with leaves to make leaf compost. Whilst this procedure (digging and lining both pits at the same time) may seem unnecessarily laborious, experience has shown that if both pits are not built at the time of the toilet programme, a second pit may never be dug and lined, or dug and lined poorly. For the *Fossa alterna* to be successful it is essential that both pits be available for use from inception.

**Photos of a fully recyclable “alternating compost VIP toilet”**





*Sequence of building/dismantling and rebuilding the recyclable brick superstructure.*



One of the two pits is dug and lined with cement mortared fired bricks. The steel frame (with door frame) is erected at the “door” end of the slab and the brick walls are built. “Sprags” of steel welded to the frame link the steel component with the brick and mortar work.



The roof is fitted after completion of the brickwork and door fitting. An asbestos pipe will also be fitted. Photo on right shows first stage of dismantling. The pipe, pedestal and roof have been removed. Now the brickwork is taken apart.



All the brickwork has been taken apart. The bricks are cleaned up. This is easy because the mortar is weak (20:1 sand and cement). On the right the same slab, having been removed from the original pit, is relocated on the second pit and mounted over a bed of weak cement mortar.





The steel frame is mounted again on the slab and the same bricks are used to rebuild the structure.



After the brickwork is complete, the roof, asbestos pipe and pedestal can be put back in place. The operation takes about 6 hours. If the pits are changed once every 3 – 5 years, this is not a huge expenditure of time and effort. Everything is recycled, even the material in the pit, which is dug out once the time has come to change sides again.



Closer views are parts of the frame. In this case the frame is made from 40mm X 40mm X 5mm angle iron. In this case the hinges are steel, but a more durable hinge can be made from car tyre. This is shown in the chapter on special construction techniques later in this book.

### The double vault brick substructure with brick superstructure

In this model the twin vaults are built as one unit below ground level, with one course of brickwork above ground level. The pit depth is 1.5 metres or more. A single slab is fitted and a brick superstructure is built on the slab. The brick superstructure is designed specifically so that it can be dismantled and rebuilt within a few hours. The structure has a wooden door which is built within a steel door frame. This is hinged to a larger steel frame fitted with “sprags” which can be bonded into the brickwork of the side walls. The bricks are bonded with a weak cement mortar being made of 20 parts pit sand and one part cement. The roof is removable being made of asbestos. The vent pipe is preferably made of asbestos which lasts longer than PVC. The pedestal is a low cost home made unit, being fabricated completely from concrete (see later chapter).

The outer brick lining of the vault is made as a single layer of bricks, with the central dividing wall a double layer as shown in the photo. The external dimensions of the brickwork are 1.3m X 1.9m. The pit depth is 1.5m or more in depth. It is desirable to plaster both sides of the pit dividing wall to reduce seepage from one pit to the other. It is also desirable to add a strong mortar to cover the uppermost course of bricks to strengthen this section as the latrine slab will be moved many times on this course. The uppermost course of bricks must lie above ground level to avoid flooding of the pit during the rains. The pit base should expose soil to allow for drainage of the liquid fraction of the excreta. Cement falling on the base of the pit should be cleaned out. In these fully brick lined structures, it is essential that dry soil and ash are added regularly, and preferably leaves also.



**The strongly built double vault substructure is built up to about two courses above ground level. The dividing wall is a double thickness of bricks and should be plastered on either side. Once the slab is mounted, a specially designed “easy to dismantle” brick superstructure is built (see above). During the first year, the second vault can be filled with leaves and soil to make leaf mould.**



**This neat and durable pedestal is constructed entirely from concrete with an internal plastic lining which is in fact a bucket. The vent pipe is fitted inside the structure. On the right, the humus from the composted vault is being removed. It was this humus that was used in the plant trials described later on in this book.**

## **Upgrading the *Fossa alterna* to urine diversion?**



The *Fossa alterna* was designed for simplicity. It is a modification of the pit toilet and is used much like a pit toilet with two changes in the way it is used – add more soil and ash etc and please – add no garbage to the pit. This allows the mix of faeces, urine, soil, ash and leaves to compost in the shallow pit. And shallow pits filled with this humus are easy to dig out.

The urine diverting unit is a pedestal or squat plate which separates the urine from the faeces. This method is described in more detail in a later chapter. Its advantages are that in separating the urine from the faeces, the faeces, which are mixed with dry soil or ash become easier to manage because they are semi dry. Also the urine, which is an excellent source of nitrogen, can be collected and used to enhance the growth of green vegetables and maize.

The *Fossa alterna* was designed specifically to operate without the use of a urine diverting unit which requires a lot more care and attention. It also costs more money. Unless great care is taken with a urine diverting unit it can give trouble. The urine must either be collected in a container or at least disposed of safely in a soakage pit. Normally faeces drop into a vault beneath the toilet and are covered with ash or soil and allowed to dehydrate. They are then later removed from the vault in an almost dry state. But men and boys may also urinate down the “dry side” where the faeces should go, and this can cause trouble with the dehydration process. Also if care is not taken in adding ash or soil, or even the faeces, the urine pipe may become blocked and require attention. Such problems cannot occur if there is no urine diverting unit present in the system. And this is why the *Fossa alterna* was conceived and designed, for its simplicity, lack of pipes and specialised pedestals. It can cope more easily with a certain amount of poor management.

However when urine diverting toilets are managed properly, they provide an excellent system, which is described later in this book. It is technically possible to add a urine diverting pedestal to a *Fossa alterna* unit (or to an *Arborloo* or any pit toilet in fact). Ideally the pedestal unit should be one where the urine pipe separates from the pedestal above the base so that the piping can be taken above ground to a suitable container or soakaway (see chapter 13). By doing so, the pedestal can still be mounted at ground level, above the pit. The urine diverter will allow urine to be collected for later use on nitrogen hungry crops or trees like banana. And it will be faeces alone which will drop into the pit with soil and ash added. The occasional addition of urine to the pit will not cause any malfunction. Indeed the *Fossa alterna* operates effectively with the full addition of urine to the pit without malfunction in almost every case. Only if the soil is incapable of accepting liquids, like clay, or if large quantities of liquids including urine are added to the pit will there be a problem, and this may be an instance where the use of a urine diverter is justified with the *Fossa alterna*.

In fact one of the secondary composting systems which can be used with a urine diverting toilet, is itself a twin pit system (see chapter on urine diverting toilets). In this case the faeces together with dry soil and ash which are added to a bucket contained in the dry vault, are actually transferred into a twin pit system to compost. The same end result would take place if the urine diverter was fitted directly over the pit itself.

The *Fossa alterna* was specifically designed to operate without a urine diverting system. But the various eco-toilets described in this book are interlinked in many ways, and there is nothing to stop the enthusiastic homesteader from adding a urine diverter to his own system.

## **Training and demonstration**

The success of the *Fossa alterna* system depends on the users understanding the concepts involved and being willing to put the simple management principles into practice. A good educational programme is therefore essential. Ideally the unit should be used by a family of about 6 persons. The pit may then take about one year to fill. If the size of the family (and visitors) remains the same, then the second pit should also take about one year to fill, which means that the pit of converting contents will have about one year to convert from excreta into humus, which should be ample time. In order to work well in practice the system of management must be made as simple as possible. The aim should be to get a pit which fills up in about a year (or more) - this includes the volume of additional ingredients like soil, ash and leaves. Pit depth can vary a little but should normally lie between 1.2 and 1.5 metres. The area of the pit will depend on the slab size and thus the size of the ring beam.

### Use of demonstrations

The potential owners of new *Fossa alternae* are best advised to see units which are already in use and talk to the owners about how they find them. Questions can be asked about the management and how useful the resulting humus is. Clearly not all people are interested in gardening - particularly those living the urban areas. There will be some variation in the uptake of this “composting system.”

### The use of models

Models can also be used to demonstrate how the *Fossa alterna* works and is used. It is often difficult for people to visualise what goes on before they see it with their own eyes. This can be done “ahead of time” by doing a demonstration with small models which are small replicas of the full size *Fossa alterna* and its double pit. Different coloured soils and sands can be used to depict the different ingredients added to the pit. People can start to understand if they see the process with their own eyes. Seeing is believing! The spoken word alone is often not convincing or effective enough to pass important messages, especially about delicate issues like the reuse of human excreta.



Two models used to teach people about the *Fossa alterna*. Models are valuable teaching aids.

### Potential problems of the *Fossa alterna*

No account of the *Fossa alterna* would be complete without a discussion of problems that may be encountered and how they can be overcome.

### **1. Pit overused.**

#### **Use of three or more “alternating” pits!**

If the “family” size is very high (including visitors, lodgers and tenants etc) a 1.2m deep pit will fill up in much less than a year. Under these conditions the rate of composting will not keep pace with the rate of new additions to the pit. It will be essential in this case to dig another pit or even another two pits to cope with the loading. In this case the structure rotates around the three or four pits, thus allowing each pit of contents more time to “convert.” Making each pit deeper, say to 1.5m will also help. By doing so the same conversions can take place in the pits, but the need to evacuate a pit “ahead of time” will be unnecessary. There will be more time for the full formation of humus. The longer the period of humus formation the higher the quality of the end product, and also the safer it will be to handle. So with a little extra space being allocated for the inclusion of a third or fourth pit, there will be increasing flexibility. This may be the preferred option in some locations where there is some space but where the households are very full and the “family” is extended. Thus a family of 6 will find the double alternating pit entirely suitable for its needs at the pit depth of 1.2m – 1.5m. But if the number of users rises to 15 or 20, two shallow pits or vaults will not be adequate. A third or fourth must be built.



**This *Fossa alterna* is actually used in a heavy duty communal setting. Three pits have been built to cope with the use.**

### **2. Inadequate soil added to the pit.**

Adding soil into a pit is not the most natural way of using a pit latrine. Many users may think the pit will fill up very rapidly and may reject the idea. In fact much of the volume of excreta is made up of water and a proportion of this can be absorbed into the dry soil which is added. *Fossa alterna* pit filling rates are often less than anticipated by users unaccustomed to these ecological latrines. If too little soil (or no soil at all) has been added to the pit, the conversion from excreta into humus will take a long time - even years. Adding just a small sprinkling of soil from time to time will not help the process at all. Fortunately it is possible to compensate by adding bulk soil/leaves/humus from time to time to the pit. And soil can be rammed into the pit at the time of changeover to increase the proportion of soil to excreta. These various methods help. It is far better, however to add the soil, ash and leaves as the pit is filling up.



### 3. Right type of soil

The best soil to add is humus like soil which is fertile and healthy. This will contain humus and a high content of living organisms like beneficial bacteria and fungi which will help to break down the faeces. Less fertile soil like sand or clay will not be so effective at converting the excreta. During the first year of operation it is wise to look around for good soil to add to the pit. After this period, some of the humus taken out of the first pit can be used to help convert future pits. However it is accepted that for most areas where the *Fossa alterna* will be put to use, the soil will be naturally poor. This is where the addition of leaves will help. The best ingredients for the *Fossa alterna* pits are excreta, soil and leaves. Ash also helps to control flies and odours and adds potash.

### 4. A good distribution of soil

The soil should be added often so it is well distributed in the pit and some soil is near to the excreta wherever it may be in the pit. By adding lots of excreta without soil and then adding a bag of soil later is not the ideal. Add soil often to get a well distributed mix.

### 5. Pit Flooding

This can happen if rain flows into the pit if there is no roof on the structure. In this case a roof will solve the problem. It can also happen if the water table rises very high in the ground on a regular basis. In this case the problem may be solved by building the pits above ground level. That means basically converting them into brick lined vaults. This method involves raising the vault completely above ground level as shown in the picture below. In this case the above-the-ground vault is used in the wet season and the latrine is placed on a ring beam placed at ground level during the dry season. Two above-the-ground vaults might also be used. It is not the ideal - then areas which are permanently flooded are not the best for human occupation, let alone the proper functioning of toilet systems.



Vault above ground and pit below the ground – used alternately.

### 6. Too much bathing!

Too much water from bathing can also lead to flooding of a pit. In fact it is not recommended that either the *Arborloo* or the *Fossa alterna* be used as a bathroom as this adds an excessive amount of water in to the pit, which disrupts the composting process. If bathroom facilities are attached to the eco-toilet, the wash water should be drained away to a separate soak pit.

## 7. Adequate pit drainage

Adequate drainage is important to the *Arborloo* and *Fossa alterna* concepts. The conversion of excreta into humus will not take place in flooded conditions. Where flooding is known to take place regularly, shallow pit methods of eco-san may not be suitable. If the soil has a high clay content and the seepage of water and excess urine from the pit will be slow, a difficult situation is created. The addition of larger amounts of dry soil and leaves from above will help. But if the pit is permanently wet with water or urine, a “dry system” like the urine diverting method (described in the next chapter) may be more successful.

## 8. Climate

The *Fossa alterna* was designed to work in a warm climate and specifically for countries in East and Southern Africa. It's operation does depend on ambient temperatures in the pit being in the range 15 – 24 degrees Centigrade for most of the year. In colder climates the rate of humus formation will be slowed down and the system may not be effective. As always when a new technology is used for the first time in a new country, it must be built somewhere on an experimental basis and examined closely for a period of at least one year, and preferably more. Only after successful trials in a new country should more wide spread promotion begin.



A sunny climate is ideal for the *Fossa alterna*

## Examples of the *Fossa alterna* from different countries

## The *Fossa alterna* in Kenya



Delegates at eco-san workshop in Mombasa construct concrete ring beams within wooden frames for *Fossa alterna* at the Mtomondoni Primary School (left). On the right the two pits of a *Fossa alterna* are lined with coral limestone blocks from the base in very loose sandy soil near a beach site at Mombasa.



School children at the Mtomondoni Primary School learn how to make concrete slabs for eco-toilets



On the left adding semi-composted "makuti," the leaf of the palm tree, to the base of a *Fossa alterna* to promote composting. On the right a finished *Fossa alterna* at Bengala Village. Both pits, dug down to 1.5m are fully lined with coral limestone blocks in loose soil. The second pit has been left empty and covered with a tin lid. The addition of soil, wood ash and leaves to excreta promotes composting in the pits. It is this promotion of the composting process which makes the *Fossa alterna* concept possible.

## The *Fossa alterna* in Malawi



The *Fossa alterna* is becoming very popular in Malawi and is being promoted by WaterAid in Salima and also in Embangweni by CCAP with WaterAid Assistance. It is also being promoted by COMWASH in Phalombe and Thyolo districts. The Malawians as well as the Mozambicans have chosen to enclose both *Fossa alterna* pits within a single permanent superstructure rather than move a portable superstructure from one pit to the other. All these units use round slabs and ring beams or pit linings mounted over circular pits. In Embangweni and Thyolo the soil is firm, whereas in Salima and Phalombe the soil is loose and unstable. These areas require different approaches to construction.



Round concrete slabs are commonly used on pit latrines in Malawi and the *Fossa alterna* also uses a round slab. Many of these are domed and use on reinforcing. Some are flat and use a small amount of reinforcing. The flat slab on left is 1 metre in diameter using a 3 to 1 mix of sharp river sand and cement and 2.5mm or 3mm wire as reinforcing. It is left to cure for 10 days. The twin pits are normally lined with fired bricks and bonded with traditional mortar. Photo taken in Phalombe district. On the right two pits dug prior to brick lining. Photo taken in Thyolo district. Thanks to COMWASH.



Simple grass superstructure for the *Fossa alterna* on the left in Njerema Village, Salima. On the right a view through the entrance showing one pit covered with a squatting slab and the second pit awaiting a cover. The *Fossa alterna* pits in loose sandy soils are lined from the bottom with bricks. Thanks to WaterAid.



On the left a grass structure for the *Fossa alterna* in Salima district. Both pits are placed within the superstructure. On the right a permanent brick structure is built over two pits lined with bricks in Thyolo.



The interior of the structure shown above on right showing the two brick lined pits within the brick structure. On the left a demonstration structure showing one pit covered with a squatting slab and the other covered with a plain slab. Photo on left taken in Thyolo, photo on right taken in Phalome. Thanks to COMWASH





Very neat *Fossa alterna* constructed in peri urban settlement near Lilongwe. The roof has still to be added. On the right a view of the interior with round domed slab.



Excavation of *Fossa alterna* pit in Embangweni. In this case the structure is a simple bamboo portable unit which is moved from one pit the other. The ground is very firm in this locality and no ring beam or pit lining was used. The pit took less than 30 minutes to excavate and the entire operation of excavating and moving the slab and structure to the newly excavated pit took less than one hour. On the right dried leaves are being placed down the new pit. These help to compost the excreta like the soil which is added.



Using the *Fossa alterna* humus. On the left the pile from the *Fossa alterna* has been brought to the vegetable garden. A shovel is used to spread the humus over the vegetable bed. On the right a hoe is used to dig in and mix the new humus into the topsoil prior to planting vegetables at the onset of the rains.



## An example from South Africa



A *Fossa alterna* built at Mbaswana, Maputaland, Kwazulu Natal, South Africa, by Partners in Development. Thanks to Dave Still and Stephen Nash.



Some work on recycling the existing pit contents of VIP toilets is also being carried out in Maputaland. On the left a previously full pit toilet, to which soil and leaves were added from the top is being dug out three years later. Previously it would have been impossible to dig out by hand. In Maputaland and elsewhere in South Africa, large numbers of VIP toilets were built years ago and many are now full.



In a new series of experiments leaves are added to the bases of dug out pits and the users asked to put plenty of soil, ash and leaves into the pit as they use it. And not to use the pit as a garbage dump. It is thought that this refinement in the way pits are used will make hand excavation easy in the future. Where twin pits are used, the family alternates the use from one pit to the other. The pits under investigation are lined with concrete rings. Each concrete ring is 1m in diameter and 40cm deep. Up to 6 rings are used to line a pit. Pits of this size (1.8 cu.m.) can last a family up to 5 years.

## **An example from Zimbabwe**

### **Changing pits in the Epworth peri-urban settlement near Harare**

This *Fossa alterna* was constructed in September 2001. It is used by a family on a plot in Epworth, where the soil is very poor. When the toilet system was first built, the second pit was filled with leaves and soil to make leaf compost. In September 2002 the leaf compost was removed from the second pit and added to a trench in which maize was late planted. The slab and structure were moved from the almost full first pit onto the empty second pit. The pit filled with a mix of excreta, soil, ash and leaves was topped up with more leaves and soil. This was left for another 12 months. In September 2003, the second pit change was made. This involved excavating the composted excreta from pit 1, adding leaves to the base of this pit and moving the slab and structure from pit 2, which was almost full, back to pit 1. The second pit was topped up with leaves and soil in preparation for a 12 month composting period. The photos below show the sequence. The pit excavation took 30 minutes and was easy work since the composted pit soil was loose. Moving the structure and topping up the used pit with leaves and soil took less than 20 minutes. The whole operation was completed in less than an hour. This attention is required once a year. The humus removed was completely converted and is a valuable resource in places like Epworth where the soil is very poor. (see later plant trials and soil analyses)



Starting to excavate the pit which has been composting for 12 months. This pit was brick lined in loose sandy soil. It was 1.1 metres deep with a cross section of about 1m X 0.7m. The pit was filled with a mix of excreta (faeces and urine) together with local soil, some wood ash and some leaves. At first the soil and leaves added on top of the excreta is removed. Further down the soil becomes darker and richer as the effect of the excreta on the soil becomes more visible. On the right photo, the richer soil is being removed.



The used pit has now been fully excavated and the compost can be seen on the side. The now empty pit has a generous layer of leaves added to the base. This helps to start of the composting process in the new pit. The addition of leaves helps a great deal to improve texture and nutrient value to the final compost.





The layer of leaves at the base of the pit. Note that small roots have invaded the pit, even through the brickwork to find the nutrients available in the composting excreta. On the right, the superstructure is now moved from the now almost full pit and placed on one side. The home made pedestal can be seen.



The concrete slab is now removed using the four handles and this is immediately placed over the now empty pit nearby. The slab is levelled and best laid on a bed of weak cement mortar laid over the pit lining brickwork.



Finally the superstructure (with pedestal and vent pipe in this case) is placed over the slab. The toilet can now be put to use immediately. On the right the pit used during the previous 12 months is not yet full, but a 12 month cycle of change is easy to remember. The pit contents are now covered with a generous layer of leaves and then topsoil is added. The mixed contents of the pit are then allowed to make compost for a further 12 months, while the used pit fills up again with a mix of ingredients. The whole process is then repeated every year. With this technique the pits are re-used repeatedly and every year a valuable supply of humus is produced. It is a simple technique which has great value.





It is wise to leave some written instructions on the inside of the toilet to remind the users how to manage the *Fossa alterna*. The regular addition of soil is essential if the process is to work properly, and also some leave and ash help to improve the compost. It helps if the time of changing pits is earmarked for a particular month of the year. In this case it is September, a good month as conditions are very dry. On the right, the composted pit contents can be bagged in preparation for the rainy season and planting. Alternatively they can be dug into the soil of vegetable gardens. A mix of half pit compost and half local topsoil is best. This mix enhanced the growth of vegetables considerably.



*Satisfied customers at Epworth!*



## **The *Fossa alterna* - a summary**

The *Fossa alterna* is a relatively new concept introduced into the world of low cost sanitation and experimentation is still continuing with this principle. Clearly there is still a lot to learn of the process of excreta conversion in shallow pits and also how this concept will be accepted by communities in Southern and Eastern Africa and possibly elsewhere. It is possible that the *Fossa alterna* concept may represent an important step forward in sanitation technology and a valuable addition to the eco-san concept. Whilst low in cost and simple and adaptable in concept, it provides a system that is easily built by the family. It controls flies and odours, and also reduces the risks of ground water pollution. Because the pits of humus are easily excavated it offers potential for a permanent solution to home sanitation, whilst at the same time providing an annual supply of valuable fertile humus for the home vegetable garden. The testing and application of the pit humus is described in a later chapter. For these reasons the *Fossa alterna* may have widespread application throughout Africa.



***Fossa alterna* or Arborloo ?**

**The two concepts are related – both make humus to enhance the growth of trees or vegetables. Both are specialised pit toilets – the link has been made between sanitation and agriculture.**

## 6. A question of health

The handling the humus withdrawn from the *Fossa alterna*, will always cause a dilemma concerned with health and safety. It must be accepted that handling these products may pose a potential health risk, especially if the facilities have not been managed properly. Only where the *Arborloo* is used, are the risks of handling almost non existent – simply because the processed human excreta lies below a generous layer of topsoil in which the young tree is planted is never handled. In fact the actual health risk of handling well composted *Fossa alterna* humus is small indeed, especially when compared to faecal contamination of hands during anal cleansing. It is only hand washing that can overcome that problem.

In the case of the *Fossa alterna*, the handling of processed excreta is encouraged - more so if the products are introduced into agriculture, which is the recommended practice. The topic of health risks related to handling or coming into contact with excreta is a large and well documented subject (see bibliography: Feachem et al. 1983, Stenström 1999, Stenström 2001). The health risks associated with handling these products can largely be divided into those resulting from the persistence of pathogenic bacteria, and those resulting from the persistence of helminth (worm) eggs.

### Health threat from bacteria

Pathogenic bacteria exhibit a natural tendency to die off when outside the human body. Several studies reveal that from a bacteriological perspective the humus derived from human excreta is relatively safe to handle provided that sufficient time is allowed for composting to take place. The 12 month recommended period for composting in the *Fossa alterna* is more than enough time for most health threatening bacteria to perish. Preliminary studies by the writer have confirmed this for periods much shorter than 12 months. Putting the problem in another and far more practical way, the threat of picking up pathogenic bacteria on the hands is significantly greater from the daily routine of anal cleansing practiced by all people compared to the infrequent handling of well composted faeces formed in shallow pits.

The survival of bacteria may be influenced by the type of management procedure undertaken in the toilets. Thus in the *Fossa alterna*, if soil is not added to the shallow pit at all, or in very small amounts, the conversion of the excreta/soil mix into a relatively safe humus will be much slower than with the recommended mix of soil, ash etc being added. However bacteriological die off within the specified 12 month period can be assured if the correct procedures are followed. In promoting the *Fossa alterna*, in particular, every means should be taken to ensure that the simple management procedure of regularly adding soil, ash and leaves to the shallow pit are followed. In those cases cited in this book, the health threat caused by handling humus will be minimal if the simple procedures are followed.

In the real world, there will be few gardeners who do not wash their hands after handling the soil and planting vegetables, and certainly before eating or preparing food. The main problem may lie in the indiscriminate behaviour of very young children who have the habit of consuming many undesirable materials from their immediate living environment.



## Health threats from parasitic worms.

On the question of parasitic worms, worm eggs and cysts which will be present in excreta deposited by infected people, may remain viable in the humus for a much longer period than pathogenic bacteria. The risks of hookworm (*Ancylostoma sp.*), roundworm (*Ascaris sp.*), tapeworm (*Taenia sp.*), *Giardia*, and other parasites must therefore form a part of this discussion of the re-use of composted human excreta and health. Thus in areas where parasites like hookworm and round worm are common, there is potentially a much bigger risk in handling the humus. It is certain that worm eggs may survive in the soil for periods longer than 12 months, but this may depend on climate and other factors. Soil is known to be an excellent environment for the maturation of *Ascaris* eggs. Their life is known to be shorter at higher pH and higher temperatures, and the application of lime or ash has been recommended and is widely used in urine diverting toilets in Mexico and elsewhere (Stenström, 1999, 2001). However the widespread application of lime, or even very heavy doses of wood ash, may not be so practical for many areas in Africa where low cost sanitation is used. Certainly this problem is more common in hotter and damper climates and thus at the coast. Existing data shows that most viable worm eggs are eliminated or greatly reduced after 10 - 12 months of composting in tropical conditions (EAWAG/SANDEX information sheet on Pathogen Survival Periods in faecal sludge). For the East and Southern African region, 6 months composting is considered adequate in at least one authoritative account (*Communicable Diseases*. (Eshuis and Manschot 1978. African Medical and Research Foundation). In South Africa, Scott demonstrated a die off of *Ascaris* in 100 days (Richard Holden pers.comm.). So even with worm eggs, the threat is greatly reduced after the recommended 12 month period of composting. *Ascaris* eggs must be ingested before an infection can take place. Infected soil must be taken in by mouth. For this reason *Ascaris* is most common in young children who eat infected soil. According to Eshuis and Manschot, except for the temporary symptoms during the lung passage, infection with *Ascaris* may be symptom-less with vague abdominal discomfort. Complications may occur in very heavy infections.

By far the simplest and most practical way of dealing with this potential problem of worm (helminth) infections, is simply a matter of extending the time of composting the faecal/soil/ash mix in a protected environment. In the case of *Fossa alterna* humus, the material can be transferred from the pit directly into a series of sacks for storage for a further period of 6 months before application to vegetable gardens. The process of “bagging” keeps the humus out of the reach of young children who are the most vulnerable (ref: S. Benenson 1990). After such an extended period of composting the risks of viable worm eggs being present will be very low indeed. However, the greatest potential threat will have been overcome within a 12 month period of composting.

In fact the bagging process will help to improve the humus further as well as making it slightly safer, as the turning of material improves aeration and this helps the composting process. It is also possible at this stage to add more soil and leaves to improve texture. The mix is bagged, watered and left to mature further, with the bag closed off. Earthworms may naturally breed in such composting bags, or can be introduced. The end result will be humus of an improved quality and a potentially safer one. The process of bagging is a simple way of secondary composting of *Fossa alterna* humus.

Where the facility is used as a strictly family unit, such parasites, if present, will be recycled largely within the family itself, and family treatment of worms may reduce the potential of loading the pit with viable eggs considerably. It is wise therefore to assess the potential

parasite risk in any area where eco-san is being promoted. In Zimbabwe, problems associated with parasites have been relatively low over a period of several decades, but as health services deteriorate, the frequency of these and other health related problems is on the increase. Poverty is linked to poor health and the general state and stability of a nation is reflected in the health of its people. Hotter and more humid areas, as may be common in most coastal regions of East and South East Africa, may be associated with higher parasite rates and thus more care is required in such areas. Children may be particularly vulnerable.

It is important to reiterate again, that any risk of handling composted human excreta must be put in its rightful place amid many other risks that toilet users are subjected to. In particular it is important to compare, once again, the risk of handling eco-humus with the risks of spreading disease from hands soiled in the toilet. The potential risk of soiling hands occurs every time we use a toilet for defecation. And without appropriate hand washing facilities being available close by, the risk of passing on the pathogens contained in raw excreta carried on the hands to other people and to food is a very real one. The stark fact remains that in Africa countless millions of people do not have access to any form of improved toilet at all. And even for those fortunate ones that do, a hand washing facility is rarely available. And this situation poses a very real threat which promotes the spread of enteric diseases. It is quite likely that the hands of users may be badly soiled with raw human excreta many times during a single month. One must compare this health threat with the threat of handling well composted eco-humus which may only arise on those infrequent occasions when the humus is actually touched by hand. The humus itself is dug out of the pit and also mixed with other soils with a shovel, which distances it from the hands. But the hands will be involved in planting seedling vegetables directly in the mix of soils. Even when mixed with topsoil again, the health threat is reduced further as the composting process continues.

Thus in any discussion of health in relation to the promotion of ecological sanitation, it is important to see the overall picture. Every step should be taken to make the humus as safe as possible, and every step taken to ensure that hand washing facilities are available and used. In this process of enlightenment, a good educational component is vital. The process of “passing on the message” is not only about how to build and maintain eco-toilet, and how to grow vegetables but also about personal hygiene and how best to practice it.

## 7. The eco-toilet and agriculture

*So far we have talked about toilets – how they are built and managed. We have arrived at the point where, in the Arborloo, we have a pit filled with excreta and soil etc ready for tree planting. In the case of the Fossa alterna we have arrived at the point where we have a pile of fertile humus next to the toilet.*

*But at that stage we have only reached the first part of our story The best part is still to come! We must now plant trees to make use of the nutrients in the Arborloo pits and also use the Fossa eco-humus (and urine) to best advantage to grow better crops of vegetables.*

The simple eco-toilets described here fit in well with the sound principles involved with organic gardening where organic materials of many types, like composted kitchen and garden wastes and animal manure etc, are recycled for the benefit of food and tree production. The use of eco-humus derived from human excreta is an extension of this idea, and there is nothing particularly new about it. Human waste, suitably composted, has been used by Man for a long time.

### The importance of nutrients in plant growth

Plants require certain chemical elements for plant growth – these are called plant nutrients. Most of these are non-mineral elements such as carbon, hydrogen, and oxygen. These elements are mainly taken up as carbon dioxide from the air and water by the roots. Sunlight also plays a major part. Increasing the supply of sunlight, carbon dioxide and water through photosynthesis also increases the growth rate and crop yield of plants.

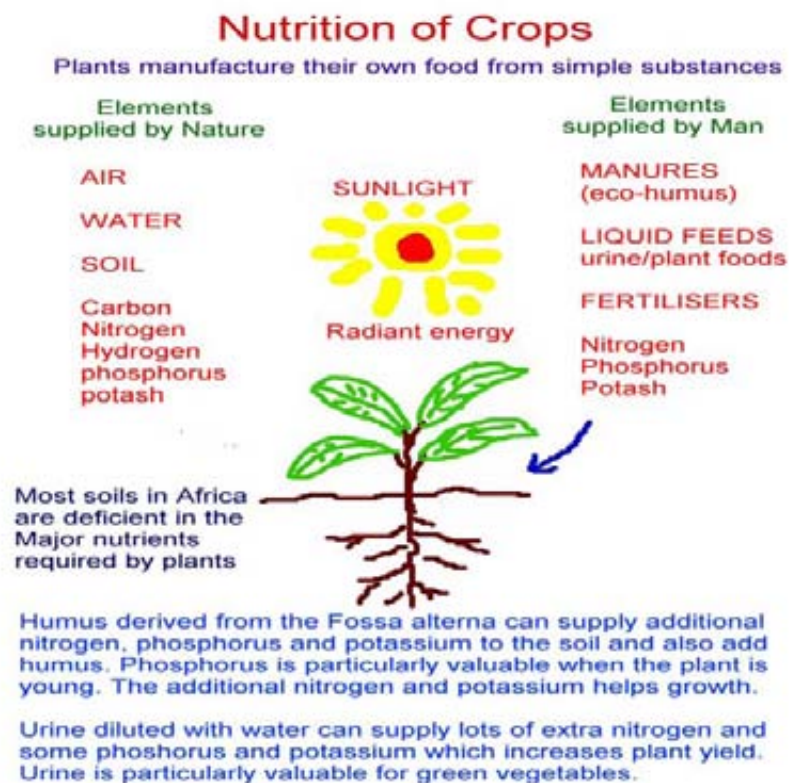

The nutrients are classified in two groups, macronutrients and micronutrients. The major uptake by plants falls in the macronutrient category. Macronutrients include nitrogen (N),



phosphorus (P), potassium (K), sulphur (S), calcium (Ca) and magnesium (Mg). These nutrients are mainly taken up from the soil by the plant roots in ionic form. Micronutrients include boron, copper, iron, chloride, manganese, molybdenum and zinc.

Each major nutrient, nitrogen (N), phosphorus (P) and potassium (K) plays a different role in plant growth and development. Each also plays a vital role, and plants grow best when there is a good balance of these essential nutrients. It is useful to record here the value of the different nutrients in plant growth and development.

#### NITROGEN

Increases size of leaves  
Increases rate of growth  
Increases final yields

TOO LITTLE - Poor pale green or yellow leaf  
TOO MUCH - Delays ripening, causes lush but soft growth. Can block uptake of potassium.  
VERY GOOD for green leafy crops and maize

#### PHOSPHORUS

Stimulates early root and shoot growth  
Hastens leaf development  
Encourages early maturity

TOO LITTLE - Poor growth  
TOO MUCH - No harmful effect  
VERY GOOD - All plants need generous supply

#### POTASSIUM

Improves health and quality of crop  
Encourages fruit production

TOO LITTLE - plants less healthy and poor fruit production  
TOO MUCH - Few harmful effects  
VERY GOOD for potash-responsive crops like potatoes, tomatoes, tree fruits & legumes

- **Nitrogen** (available as nitrate) is the most important nutrient involved in vegetative plant growth and leaf building – it also helps to increase the final yield of crops. It is required in relatively large amounts. Plants deficient in nitrogen have pale leaves and look weak and the lower leaves gradually turn yellow, as the plant transfers the vital nutrients to where they are most needed in the formation of new leaves. However nitrogen cannot do its work unless phosphorus, potassium and other elements are also present in the soil in sufficient quantities. An excess of nitrogen can also reduce the uptake of other important nutrients like potassium which is important for the general health, fruit formation and disease resistance of plants. Most soils in Zimbabwe and surrounding countries are very deficient in nitrogen. Nitrogen is quickly washed out of the soil after heavy rain or watering, and needs to be replaced fairly often.
- **Phosphorus** is important because it gives a good start in life for plants by assisting strong root growth and shoot formation. It is also a good fruit builder and encourages early maturing and ripening. It hardens stems and vegetative growth and increases resistance to disease. Unlike nitrogen, which is easily flushed out, it is held by the soil and does not need to be replaced so often. Also unlike nitrogen and potassium, it does not burn plants. Generally phosphorus is deficient in most top soils in this part of Africa. A deficiency in phosphorus results in poor root growth which is revealed later by slow plant growth in general. One indication of deficiency is the purpling of leaves. There is seldom an excess of phosphorus in any soil. It is a very precious mineral in short supply unlike nitrogen which is available in abundance and potash which if

needs be can be taken from wood ash. Most soils in Zimbabwe and surrounding countries are very deficient in phosphorus.

- **Potassium** (potash) builds fibre & skeletal growth in the plant and also helps to promote good fruit development. It promotes the general vigour and health of plants. A balance must be maintained between potassium and nitrogen as they interact with each other. Many important plants are “potash hungry” like tomato, potato, onion, runner bean – so potassium is important in our story. Potassium is not washed out of the soil as easily as nitrogen but is not held as strongly as phosphorus. Most soils in Zimbabwe and surrounding countries are very deficient in potassium.

Most garden fertilisers have a balance of nitrogen, phosphorus and potassium for use on vegetables. The ratio of the “NPK” in fertilisers, with phosphorus predominating, indicates that on the phosphorus deficient soils in Zimbabwe, most require more phosphorus than nitrogen overall. As the plants mature, more nitrogen may be required. Most leafy vegetables respond very well to the application of nitrogen after they have become established and this is available in large quantities in urine. Fruiting vegetables and root crops require far more potassium as they mature, and an excess of nitrogen may retard fruit growth, favouring lush leafy development. But each vegetable or crop has its own specific requirements. Also different soils vary greatly in what nutrients they can naturally provide for the plants. So the application of *Fossa* humus and urine to plants may result in a variable reaction, depending on the soil used and the type of plant grown. The *Fossa* humus improves soil texture and a good balanced supply of additional nutrients to the soil and most plants respond very favourably to its application.

### **Fruit and trees.**

All plants have the same basic requirements, whether they are vegetables or trees. Thus in the early stages of a trees growth, phosphorus will be required for good root and early shoot growth. Nitrogen once again will be required for vegetative growth. But fruit bearing trees do require plenty of potassium to produce of their best. Perhaps this is why young tree grow well on composted human excreta – it does contain generous supplies of phosphorus.

All fruit trees need adequate fertilisation to produce their best yields. Feeding of some sort is required every year, with manure, compost, diluted urine or other fertilisers. The amount of plant food required increases as the tree grows larger. In the case of citrus trees about 10 kg of manure or compost is required per tree per year for the first two years. This increases to 15 kg in the 3<sup>rd</sup> year, 20 kg in the fourth year, 25 kg in the 5<sup>th</sup> year, 30 kg in the 6<sup>th</sup> year, 35 kg in the 7<sup>th</sup> year, 40 kg in the 8<sup>th</sup> year and 50 kg between the 9<sup>th</sup> and 14<sup>th</sup> years. 10 kg is a wheelbarrow full or 150 gms ammonium nitrate, 200 gms single super-phosphate and 200 gms potassium chloride. For guava about 15kg manure or compost is required in the first year, 20 kg in the second and 45 kg from then on. Similar amounts are required by mulberry and avocado. Mango requires 10 kg manure or compost spread out through the year during the first year, 16kgs from the 3<sup>rd</sup> to 4<sup>th</sup> years, 18kgs for the 5<sup>th</sup> and 6<sup>th</sup> year and after 11 years about 60 kg. For Bananas about 15 kg manure or compost are required every year for each banana clump.

In ecological sanitation, the *Arborloo* is the closest link between the toilet and the tree. The nutrients present in the composted excreta, will be enough to start the tree off and a good quantity of phosphorus will be present and sufficient nitrogen and potassium to feed the tree for a year or two. The analysis of compost from a few *Arborloo* pits and from those *Fossa*

*alterna* pits analysed (see below) show that even after a year of composting the nutrient level is high. Once the tree is planted, the nutrients held within the pit compost will start to be used up. So after two years, annual feeding of the fruit trees will be required to gain the best fruit yields. Urine can supply plenty of nitrogen, but less potassium. So the best way of applying urine is to dilute the urine (5:1) and add wood ash. The exact amounts required are still being worked out. As the tree grows larger, more will be required. A single charge in a watering can will be a mix of 2 litres urine to 10 litres water with a mug full of ash added and stirred in. Once the young tree is 2 years old, a mix of 2 litres, urine diluted with 10 litres water with a mug full of ash mixed in can be applied twice a month during the rains and with additional watering at other times. As the tree grows much larger quantities are required. It is important to keep the level of potash high in relation to nitrogen for best fruiting. The annual application of manure or compost will also help to sustain fruit output from trees.

## Soil pH

For most crops the pH of the soil is best at a value of around 6.0 to 6.5. That is just slightly acid. At such a pH bacteria of the helpful kind will enjoy good conditions. The various soil nutrients will be kept in an optimum state of availability, various fungi that cause disease will find unfavourable conditions and the soil will tend to granulate to a more favourable size. If the pH drops too much below 6.5 or 6.0 then phosphoric acid ceases to be available. If the pH goes up to high, that is towards alkalinity, then certain trace nutrients will become entirely unavailable eg manganese, iron, copper, zinc, boron, and such a condition would be very hard to correct. There is therefore a serious danger in the over use of lime.

## Special requirements

We have already mentioned that some plants require increased amounts of certain nutrients to give their best yields. All young plants require generous phosphorus and perhaps that is why the amount of phosphorus available in most general fertilisers contains more phosphorus than the other main nutrients. *Fossa alterna* humus does contain quite a generous supply of phosphorus. Most green vegetables and maize respond to a good supply of nitrogen, and diluted urine has much nitrogen. Indeed most plants respond positively to diluted urine if applied carefully during their main phase of vegetative growth. Several important plants like tomato, onion, potato and some types of bean need more potassium to give their best yields and this can be supplied by applying wood ash. Wood ash can also be applied in a liquid feed with diluted urine, or with water. Alternatively a liquid feed made from composted leaves in which comfrey leaves are included provides a good mix of nutrients including potassium. Most plants respond positively to soil to which compost has been added. As the plants use up nutrients for their growth, the soil requires replenishment, from whatever suitable source is available.

## Nutrient levels in *Fossa alterna* humus

It is interesting to record that the balance of available nutrients in humus derived from the *Fossa alterna* is well spread between nitrogen, phosphorus and potassium, as they would be in commercially available general compound vegetable fertilisers. By comparison, urine has a very high level of nitrogen in relation to both phosphorus and potassium. Thus the effect of applying urine is much like applying a rich nitrogen fertiliser. Urine is particularly useful for promoting the growth of leafy vegetables like rape, covo and spinach, once they are established. Maize also responds very positively to the application of urine.



Soil analysis of *Fossa alterna* humus shows it is rich in the main plant nutrients as can be seen from the following table. The figures below show the pH and levels of nitrogen (ppm - after incubation), phosphorus (ppm), and also potassium, calcium and magnesium (ME/100gms.) in twelve samples of the *Fossa alterna* taken from the Friend Foundation (10 samples), Epworth (one sample) and Woodhall Road (one sample), all in the Harare area. Later these figures are compared to various naturally occurring top soils in Zimbabwe in the Harare area.

#### NUTRIENT LEVELS IN *FOSSA ALTERNA* HUMUS

Soil source	pH	N	P	K	Ca	Mg
Sample 1. (Friend Foundation)	6.5	269	317	1.59	20.77	11.28
Sample 2. (Friend Foundation)	6.1	246	330	4.64	5.53	5.41
Sample 3. (Friend Foundation)	6.6	174	374	3.74	8.59	5.74
Sample 4. (Friend Foundation)	6.2	222	422	2.22	3.60	3.57
Sample 5. (Friend Foundation)	6.5	319	196	3.26	13.70	7.26
Sample 6. (Friend Foundation)	7.7	316	242	3.84	9.96	3.42
Sample 7. (Friend Foundation)	7.6	355	258	7.14	8.97	6.26
Sample 8. (Friend Foundation)	6.9	305	230	6.65	12.00	10.32
Sample 9. (Friend Foundation)	7.7	354	257	9.18	9.26	3.46
Sample 10 (Friend Foundation)	6.3	197	299	2.94	26.64	4.77
Sample 11 (Epworth)	7.1	240	194	2.80	5.22	3.65
Sample 12 (Woodhall Road)	7.8	285	228	2.80	9.24	2.33
Mean value ( <i>Fossa alterna</i> )	<u>6.86</u>	<u>273</u>	<u>278</u>	<u>4.22</u>	<u>11.11</u>	<u>5.61</u>

#### Enhancement of deposited soil

The quality of the humus derived from *Fossa alterna* pits varies depending on what extra ingredients are added to the pit in addition to excreta (urine and faeces). The texture, nutrient levels and water holding capacity, for instance, are improved if fertile topsoil and leaves are added in addition to the excreta. The texture of the excavated humus is similar to the soil added to the pit. However, even when poor soil is added alone, significant improvements can be achieved in nutrient levels as the results below show. In the cases cited below, soil analyses were made on the soil added to the pit as well as the soil (humus removed).

<b>Example 1.</b>	pH	N	P	K	Ca	Mg
Soil added to FA pit (cemetery topsoil)	4.9	50	13	0.18	2.95	0.78
<b>Humus removed from <i>Fossa alterna</i></b>						
Sample 4	6.2	222	422	2.22	3.60	3.57
Sample 6.	7.7	316	242	3.84	9.96	3.42
<b>Examples 2, 3 and 4</b>	pH	N	P	K	Ca	Mg
Soil added to FA pit (kennels site. pit soil)	5.5	27	5	0.29	10.23	4.11
<b>Humus removed from <i>Fossa alterna</i></b>						
Sample 7.	7.6	355	258	7.14	8.97	6.26
Sample 8.	6.9	305	230	6.65	12.00	10.32
Sample 9.	7.7	354	257	9.18	9.26	3.46

<b>Example 5 (Epworth sample 11)</b>	pH	N	P	K	Ca	Mg
<b>Soil added to FA pit (Epworth topsoil)</b>	<b>4.1</b>	<b>23</b>	<b>54</b>	<b>0.07</b>	<b>1.72</b>	<b>0.50</b>

Note local dried leaves and some wood ash were also added to the pit)

<b>Humus removed from <i>Fossa alterna</i></b>						
<b>Sample 11 (Epworth)</b>	<b>7.1</b>	<b>240</b>	<b>194</b>	<b>2.80</b>	<b>5.22</b>	<b>3.65</b>

<b>Example 6 (Woodhall Road sample 12)</b>	pH	N	P	K	Ca	Mg
<b>Soil added to FA pit (Woodhall Rd soil).</b>	<b>6.2</b>	<b>27</b>	<b>32</b>	<b>0.63</b>	<b>9.68</b>	<b>2.30</b>

Note dried guava and avocado leaves were also added to the pit)

<b>Humus removed from <i>Fossa alterna</i></b>						
<b>Sample 12 (Woodhall Road)</b>	<b>7.8</b>	<b>285</b>	<b>228</b>	<b>2.80</b>	<b>9.24</b>	<b>2.33</b>

We can now compare the nutrient levels found in *Fossa alterna* humus and mixed soils with a series of samples taken of naturally occurring top soils taken in the Harare area.

### Examples of naturally occurring top soils

Soil source	pH	N	P	K	Ca	Mg
<b>Harare (Tynwald 1.)</b>	<b>6.1</b>	<b>32</b>	<b>68</b>	<b>1.59</b>	<b>6.42</b>	<b>4.02</b>
<b>Harare (Tynwald 2.)</b>	<b>5.5</b>	<b>27</b>	<b>5</b>	<b>0.29</b>	<b>10.23</b>	<b>4.11</b>
<b>Harare (Marlborough Vlei)</b>	<b>5.1</b>	<b>72</b>	<b>30</b>	<b>0.99</b>	<b>22.88</b>	<b>18.06</b>
<b>Harare (Epworth 1)</b>	<b>4.0</b>	<b>18</b>	<b>9</b>	<b>0.08</b>	<b>1.46</b>	<b>0.32</b>
<b>Harare (Woodhall Road)</b>	<b>6.2</b>	<b>27</b>	<b>32</b>	<b>0.63</b>	<b>9.68</b>	<b>2.30</b>
<b>Ruwa (Knuth Farm 1. veld)</b>	<b>7.5</b>	<b>30</b>	<b>30</b>	<b>0.12</b>	<b>3.79</b>	<b>0.56</b>
<b>Ruwa (Knuth farm 2. pit soil)</b>	<b>5.1</b>	<b>14</b>	<b>23</b>	<b>0.01</b>	<b>1.12</b>	<b>0.48</b>
<b>Ruwa (Knuth farm 3 - garden soil)</b>	<b>6.7</b>	<b>96</b>	<b>143</b>	<b>0.73</b>	<b>15.23</b>	<b>1.96</b>
<b>Harare (Epworth 2)</b>	<b>4.1</b>	<b>23</b>	<b>54</b>	<b>0.07</b>	<b>1.72</b>	<b>0.50</b>
<b>Mean value (local soils)</b>	<b>5.5</b>	<b>38</b>	<b>44</b>	<b>0.49</b>	<b>8.05</b>	<b>3.58</b>

According to the Chemistry and Soil Research Institute, many naturally occurring top soils found in Zimbabwe reveal very low levels of nutrients available for plants. This is caused by weathering, lack of tree cover, and the effects of rain on badly eroded soils. A nitrogen level in soil of less than 20ppm is regarded as low, 20 – 30 as medium, 30 -40 adequate and 40 plus is regarded as “rich”. So the soils produced from the *Fossa alterna* are rich indeed, with those in our range of naturally occurring soils being in the adequate range.

For phosphorus, less than 7 ppm is regarded as low, 7 – 15 marginal, 15 – 30 medium, 30 – 50 adequate and 50 plus “rich.” Thus once again the natural soils tested were in the adequate range. Once again the *Fossa alterna* humus is rich in P, which is a valuable component. It can be mixed with local top soils to get an enhanced production of vegetables, which is what this story is all about. Critical ranges for Ca are 15 – 20ppm, and 0.3 – 0.4 meq/100g for Mg and 10 – 15ppm for K.

The top soils of many parts of Southern Africa are worn out and almost devoid of humus or nutrients. In Zimbabwe 70% of rural farmers work on a soil which is labelled as poor or very poor. Nitrogen, phosphorus and zinc, amongst other minerals were seen as limiting to meaningful agriculture in 70% of samples collected around Zimbabwe. Most soils are sandy and have a low pH. Few soils in the rural and even peri-urban and urban areas can sustain any form of healthy crop production without meaningful inputs of both humus and nutrients (Farai

Mapanda (pers.comm). Thus any form of fertile humus which can be locally produced and mixed with the poor local topsoil can only be seen as advantageous.

### Summation of levels of nutrients in *Fossa alterna* soil compared to local top soils

Soil source	pH	N	P	K	Ca	Mg
Mean value (local soils)	5.5	38	44	0.49	8.05	3.58
Mean value ( <i>Fossa alterna</i> )	<u>6.86</u>	<u>273</u>	<u>278</u>	<u>4.22</u>	<u>11.11</u>	<u>5.61</u>

### The value of leaves as an additive to *Fossa alterna* pits.

Constant reference is made to the considerable benefit which can be derived by adding leaves to *Fossa alterna* pits. Leaves help the composting process considerably, by adding more air into the mix, and by adding a composting process undertaken by fungi to the already existing bacteriological process undertaken by soil micro-organisms. Leaves also increase the organic proportion of soil and thus improve its humus content.

During the first year of operation, the second pit of the *Fossa alterna*, which must be built at the same time as the first pit, can be left empty and covered with a wooden lid. This will be the standard procedure. However it is possible to take advantage of the second pit during the first year of operation. One of the best methods is to make leaf compost within this pit for the first year of operation. This is carried out by adding dry leaves to the pit, together with thin layers of soil. More leaves and soil are added once the initial batch has condensed in volume. Water is added from time to time to keep the contents slightly moist.

At one site in Epworth close to Harare, leaves were gathered and emptied into the second pit of a *Fossa alterna* interspersed with thin layers of the local topsoil. Water was added from time to time. After 12 months the leaf compost was excavated and proved to be much richer in nutrients than the original soil. In fact plants grew in this leaf mould far better than in the original soil. The second pit acted like a pit composter and was well worth the simple effort involved of adding leaves, soil and water. The following table shows the increase of nutrient levels in the leaf compost made in the second pit compared to the local topsoil

The figures below show the pH and levels of Nitrogen (after incubation), Phosphorus, (ppm) and also Potassium, Calcium and Magnesium (ME/100gms.) in the leaf compost formed in the second pit of a *Fossa alterna* compared to the surrounding topsoil which was added together with local leaves.

Soil source	pH	N	P	K	Ca	Mg
Local topsoil (Epworth)	4.1	23	54	0.07	1.72	0.50
Leaf compost from second pit	7.7	81	130	1.86	9.31	1.88

Composted leaves clearly have a considerable nutrient value of their own and no doubt greatly enhance the final quality of *Fossa alterna* humus, if added. The results of four soil analyses of leaf mould formed in wire baskets and a variety of containers is given below. A description of these leaf mould makers is given later in this book. As we shall see later, the addition of leaves also improved the efficiency of composting in shallow pits.



## Analysis of leaf mould

Soil source	pH	N	P	K
Leaf compost in wire basket	8.2	256	344	3.92
Leaf compost formed in plastic bag	7.8	267	294	8.50
Leaf compost formed in steel drum	7.6	239	255	0.60
Leaf compost formed in brick moulder	7.4	540	266	9.00

## Overall comparisons of soils and composts

Soil source	pH	N	P	K
Mean value (local top soils)	5.5	38	44	0.49
Mean value leaf mould	7.75	325	290	8.00
Mean value ( <i>Fossa alterna</i> )	6.86	273	278	4.22

## Physical properties of excreta, soil, leaf mixes.

One interesting property of excreta or mixes of excreta and soil, both in jars and pits is that the volume is considerably reduced over time. Even with abandoned full latrine pits the volume may decrease considerably over time. In urine diverting toilets the urine is channelled away and the faeces dehydrate or compost and loose their initial volume due to loss of moisture. In shallow pits the combination of urine and faeces also loose volume over time with the urine being absorbed into the soil added to the pit and also into the soil surrounding the pit. The bulk and volume of the faeces is also reduced over time with the liquid fraction of the faeces being absorbed into the soil added to the pit. It is known that the water content of the faeces is variable but always high. It is this larger water fraction of the faeces which can be absorbed into other ingredients added to the pit (soil, ash, leaves), whilst the remaining smaller solid fraction of the faeces is converted into humus, which forms part of the final total volume of the humus formed in the pit or jar.

### But what are the fractions?

The following experiment was carried out to calculate the percentage water content of faeces by combining a known weight and volume of faeces with a known weight and volume of dry soil. Since the dry soil would loose neither weight of volume, any change in the final volume and weight of the mix would be caused by changes in the properties of the faeces.

A sample of faeces was collected in the *Skyloo*. This sample weighed 357gms, had a volume of 340mls and a density 1.05 gm/ml. This was mixed with a near equal volume of dry soil with a weight of 352gms, a volume of 310mls and a density of 1.135 gm/ml. Therefore the total weight of the mix was 709gms having a volume of 650mls and an overall density of 1.084 gm/ml.

This was allowed to slowly compost over a period of 24 days. Fly larvae developed in the mix, which also attacked by ants. Slowly the mix changed into soil. Another mix was made with an approximately equal mix of faeces, dry soil and crushed dry leaves. This mix was also allowed to compost for the same period.



On the left, raw faeces and soil being mixed prior to composting. On the right a mix of leaves, soil and raw faeces prior to mixing and composting

After the period of composting both samples were laid out in the sun to substantially dry out, but not to full dessication status. The final weight of the dried soil/faeces mix was 420gms, with a volume of 405 mls and a density of 1.037gm/ml.

Thus the weight of the “new soil” formed had increased from 352 to 420g (about 19%), compared to the original soil in the mix and the volume of the “new soil” had increased from 310mls to 405mls (about 30%) compared to the original soil in the mix. Since the volume and weight of the dried original soil cannot change, the faeces weight had therefore been reduced from 357g to 68g (420 - 352g) - 19% of original. **So the water content of faeces was 81%.** The faeces volume had therefore been reduced from 340mls to 95ml (405 - 310ml - 28% of original). So the final density of the mix was less than the original soil. The mix was also darker in colour. The overall weight of the combination was reduced from 709g to 420g (59.23% of original). The overall volume of the combination was reduced from 650 ml to 405ml. Thus the composting process of soil and faeces reduced the volume to **62.3%** of the original combined volumes.

The processed combination of “NEW SOIL” was very similar in appearance to the original soil since 76.5% of its new volume and 83.8 % of its new weight consists of the original soil.

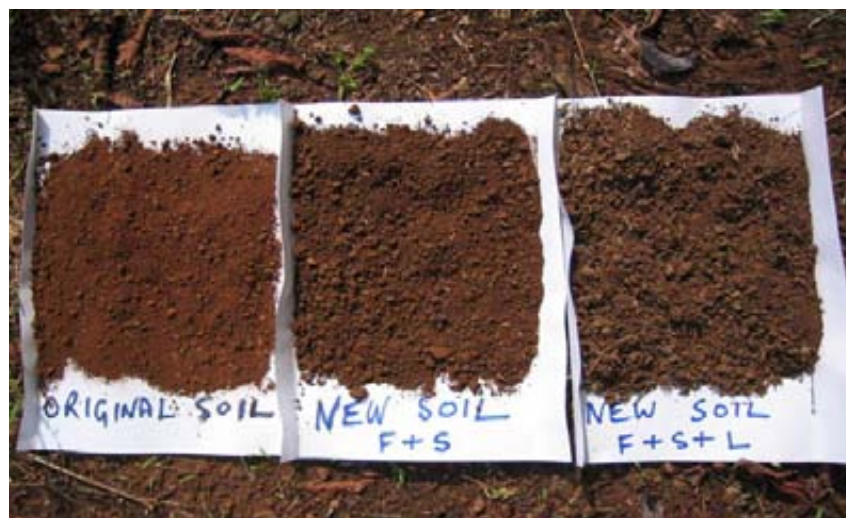

Samples of original soil (left), and “new soil” made from faeces and soil (centre) and from faeces, soil and leaves (right)

In the case of the faeces/soil/leaf mix a final weight of 270gms was measured with a volume of 405mls. This gives a density of the combination of 0.66gms/ml. This is a much lower

density compared to the faeces/soil mix (1.037gm/ml). Clearly the addition of leaves lowers the density of the mix, a result no doubt of less compaction and more air in the mix due to the presence of leaves. These properties would encourage far more efficient composting. Composting is far more effective as the air content increases. This is a very important finding.

### Density trials on *Fossa alterna* humus

The results shown above would explain why a mix of excreta, soil and leaves appears to compost much faster than a mix of soil and excreta only. To test this theory the humus taken from a *Fossa alterna* which had a mix of excreta, soil and leaves was compared for weight and volume to the humus taken from another *Fossa alterna* which had a mix of excreta and soil only. The initial comparisons (for volume, weight and density) were made in crumbly (not dried) *Fossa alterna* humus. These samples were then dried out in the sun to obtain new parameters.

#### *Fossa alterna* soil (crumbly, not dried)

Soil /humus type	Vol. ml	Wt.gm	density
FA kia (excreta, soil, leaves)	410 (jam jar)	370g	0.90g/ml
FA FF (excreta & soil only)	410	402g	0.98g/ml
Garden soil	400	443g	1/10g/ml

#### *Fossa alterna* soil (sun dried)

Soil/humus type	vol. ml	Wt.gm	density
FA kia	325	278	0.85g/ml
Fa FF	370	338	0.91g/ml
Soil	368	392	1.06g/ml

These results reveal that where leaves are added to the *Fossa alterna* pit the resulting density of the humus is lower. The density of the humus is related to both the moisture content and the air content. The more air (with some moisture) the better the conditions for composting. Thus a mix of excreta, soil and leaf in the *Fossa alterna* pit is more effective and leads to a faster and more efficient composting process than the mix of excreta and soil alone.

Thus leaves are an important ingredient in this process, not only because they provide extra nutrients, but also because they lower the density of the mix and provide extra air, thus increasing the efficiency of composting. They also add a process of fungal decay in the mix as well as composting based on bacteria. They also provide a larger surface area for the composting process to take place and allow for better pit drainage. All these combined beneficial effects of leaves enhance the composting process considerably.

Consequently the addition of leaves to the shallow pit composting process in both the *Arborloo* and *Fossa alterna* has been greatly encouraged in programmes of implementation. Similarly leaves are now added to the buckets holding faeces, ash and soil in the *Skyloo* and also to the jar and shallow pit secondary compost sites.



## Adding leaves to shallow pits

Adding dried leaves to shallow pits used in the *Arborloo* and *Fossa alterna* helps the composting process considerably.



Adding leaves to *Fossa alterna* pits. On left at Woodhall road, on right at Epworth.



Adding semi composted palm leaves to the base of a *Fossa alterna* pit in Mombasa, Kenya (left). Two sacks full of leaves at the base of a concrete lined pit in Maputaland, South Africa.

### Conclusions

These various results show that the *Fossa alterna*, when well managed, offers the family a valuable asset, which is not only an effective toilet system, controlling both flies and odours, but also provides an excellent source of humus for the vegetable garden. Soil analysis reveals why the addition of humus derived from the *Fossa alterna* pit every year helps to enhance the fertility and nutrient levels of an existing vegetable bed. This can greatly enhance back yard vegetable production (see plant trials later). By combining these advantages with its low cost and relative ease of use and management, the *Fossa alterna* may hold much potential for future use in many parts of Africa. Since the same ingredients are also added to the *Arborloo* pit, it is logical to suppose that young trees will also gain much benefit, in their early life. Many generations of experience in countries from all over the world can vouch for the improvement of tree growth in old toilet pits. Even the Pilgrim Fathers used the idea when they arrived in the New World. The same method is practiced in many countries in Africa today. The *Arborloo* concept is an extension of a well established and widely used traditional method. The formation of humus by mixing soil, leaves and excreta was invented by Nature itself.

## 8. The *Arborloo* and growing trees

After a period which can vary from a few months to a few years, depending on the pit size and extent of use, the *Arborloo* eco-pit will be filled with a composting mix of ingredients. It is time to move the structure, including the concrete slab and any ring beam to a new site. The toilet itself moves on a “never ending” journey, through the “lands.” A new site will have been chosen and possibly a pit dug, but it is always wise to place the ring beam first and then dig the pit within the ring beam. This makes a much more stable unit.

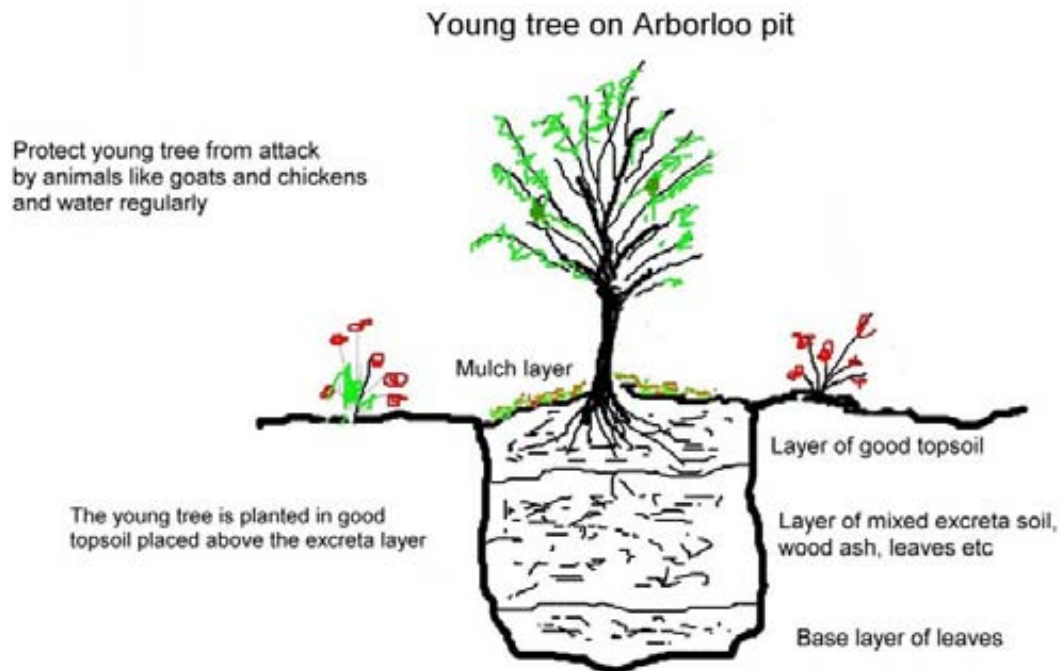

### Preparations for tree planting

The contents of the used pit (filled with excreta, soil/ash/leaves etc) are now levelled off and topped up with a generous layer of leaves followed by fertile soil, at least 150mm deep. This soil can come from old compost heaps, fertile soil/leaf litter found under trees or any other place where the soil looks good. The aim is to plant the young tree in topsoil so the roots are placed well above the composting excreta layer below.

What is important with the *Arborloo* is that a generous layer of soil (15cm) is laid over the excreta/soil layer in which the young tree is planted. If a good layer of leaves followed by topsoil is added to the excreta in the pit, the young tree can be added the same day as topping up with soil. But there is no reason to delay the movement of the latrine if no trees are available for planting. The latrine can be moved and the pit topped up with soil awaiting the arrival of a new young tree. In fact some may prefer this method, as it gives time for the excreta in the pit to partly convert into humus before the tree is planted. More topsoil can then be added before planting. If water is scarce, it is actually advisable to delay tree planting until the rains begin. Then the chances of the young tree dying as a result of a lack of water will be much less. Young trees need a lot of care, protection and water.





**Left: Women from the Sanitation club in Epwengeni Village, Embangweni, Malawi, perform a play showing how trees are planted in *Arborloo* pits. The Village has large numbers of *Arborloos* in operation. Right: Young fruit tree being planted by children in Embangweni, Malawi. Right photo: Jim McGill.**

### **Planting young trees**

Young trees can be obtained from a nursery, or in some cases can be taken from cuttings from existing trees (mulberry, banana) or can be grown from seeds (guava, paw paw, mango, avocado etc). This is described in the chapter on gardening techniques. Mulberry, banana, gum, mango, guava, paw paw & avocado do well. In fact most trees will thrive if given the right opportunity. Citrus trees can also be grown, but need more care. Experiments in Harare have shown that when planted in a good layer of topsoil covering very organic pits, most trees will thrive, including a wide range of fruit trees, indigenous trees, ornamental trees and trees used for construction or fuel. At least three things are important for young trees.

1. Keep the young tree roots well away from the excreta layer.
2. Protect the young tree from goats, chickens etc with a protective basket
3. Water regularly. A mulch of leaves or grass helps to retain water in the soil.



**Left: Right: In a programme in Kusa Village on the shores of Lake Victoria, Kenya, many young trees have been planted on *Arborloo* pits. This young citrus tree is being planted in the soil placed above the pit contents. Thanks to RELMA. Right: This *Arborloo* at the Eco-Ed Trust has just been moved onto a new site (rear right). The old pit has been topped up with soil, a tree planted and mulch added. Note substantial protection against animals. Thanks to Jim and Jill Latham, Eco-Ed Trust.**



The growing roots of the young tree first invade the topsoil layer, whilst the excreta below is turning into humus. So the young tree does not immediately gain benefit from the formation of humus derived from human excreta. This benefit will be realised later on. Because of the highly rich nature of the pit contents, there may be invasions of the pit by roots already present in the soil. If the young tree for any reason begins to struggle, a new tree can be planted later. Also if the trees are very young it may better to allow them to establish themselves in buckets, pots or larger containers first, so the root system can grow more extensively and become more resilient before transplanting into the pit. Experimentation will be required. There will be a variation in local conditions - soils, climate, season etc. The most suitable tree type will vary with the area and altitude. Also the owner will choose some trees in preference to others. Some may choose trees for fruit, others for fuel, others for shade etc. The banana is perhaps the most widely grown fruit tree on traditional latrine pits. But the orange and tangerine are the most popular in more recent *Arborloo* programmes.

In some cases the tree may not grow fast at first, a condition known as “hesitancy.” Obviously a pit full of richly organic material may not be the most ideal environment in which young trees can grow. But with time, the conditions of the pit become favourable. Some trees are more tolerant of the richly organic conditions than others. Mulberry is a very good tree species to start. It makes tasty fruit and is very tolerant of the rich pit environment. It can also be grown from cuttings.

### **Looking after young trees**

There are some trees which may fail to grow on the first attempt for various reasons. Sometimes these will have been attacked by goats or chickens or dug out or trodden on by children, or simply not watered. Sometimes a poor soil will have been chosen to cover the excreta layer or the soil layer may have been too thin (trees will die if placed in or very close to raw excreta!). And some trees are hardier than others. So some tree deaths can be expected. Try again with a new tree - replanting is the order of the day!

Common gardening practice must be applied to the planting of young trees. The soil should be fertile (that is the layer of soil placed on top of the excreta). The young tree should be healthy, protected against animals, children, possibly excess sun and it must be watered regularly. The soil should ideally be covered with a layer of mulch. Mulch is a very valuable addition to the topsoil. It is a layer of material, preferably organic material that is placed on the soil surface around the tree. It is a protector of the topsoil. The layer of mulch helps to conserve moisture in the soil and thus reduces the amount of water required. It holds down weeds and also protects the soil from the effects of sun and wind. The layer of mulch improves the soil structure and fertility. It can be made of leaves, leaf compost, grass cuttings, compost or other decomposing vegetable matter. Some animal manure, compost, etc or other suitable fertiliser might even be dug into the topsoil to assist the young plant once established. Here the local forestry or nursery people will know what to do. The aim is to help the tree to get established and stabilised in the layer of topsoil, in preparation for its penetration into the decomposing layer.

### **Hesitancy**

For various reasons a young tree may hesitate to grow with maximum vigour at first. It may be stressed for a number of reasons and that is why every effort must be made to encourage the young tree in its first months after transplanting. If all other factors in the topsoil are ideal,

the tree should have a good start. But if the organic layer is too close to the roots the plant may hesitate or even die. The tree roots are actually quite sensitive to the soil beneath and the plant as a whole may wait until it senses the best time to start growing more rapidly. That is when the excreta is fully converted into a humus which can be tolerated by the roots. There is a balance between the rate of conversion from excreta to humus and the rate of growth of the roots into the deeper layers. One thing is certain, when the time is right, the young tree will certainly begin to grow vigorously.

## **Replanting**

If for any one of a number of reasons the young tree does not grow, it should be replaced. If the plant struggles for a period of 3 - 4 months then it is best to take the tree out and replant with a new tree. It may be wise to take out the composted soil from the pit, loosen and mix up and reapply to the pit and replant the same tree or preferably a new tree and water etc. Some trees are stronger and more tolerant than others, even when they come from a nursery. Some people who dig out the tree pit prefer to use the humus on their vegetables. That choice is of course optional. Many people may decide the humus is more important on vegetables. But opinions vary greatly.

## **Feeding the trees**

All trees require a good supply of nutrients if they are to grow well. This is particularly true for fruit trees which are planted to produce fruit. The amount of fruit produced will eventually depend on how much nutrient the tree can gain from the soil. The early growth of trees can certainly be sustained from the nutrients held in the composted pit soil. But during heavy rain, part of the nitrogen will be lost from the topsoil, although phosphorus is normally held in place far better by the soil. Also trees use up much of the nutrients held in the soil and their root systems search wider and wider for a supply of food. So for the best results, particularly with fruit trees, extra feeding will be required.

Each type of tree has its own very specific requirements for feeding. Avocado pears, for instance, require more phosphate and potash and very little nitrogen. Banana trees require large amounts of nitrogen and potash. Citrus trees require more of a balanced diet. When fed with compound fertilisers, fruit trees require between 250 – 500gms of fertiliser per year for each year of life if they are to produce good yields. This is normally given in 2 or 3 doses over the year. However, all trees require the most phosphorus at an early stage of root growth and shoot formation. Then they require more nitrogen for vegetative growth. But the final stage is critical. The trees require generous amounts of potassium to produce fruit in abundance.

It is wise to dig in compost or manure around the tree from time to time. For most trees, about 10 kg manure or compost (a wheel barrow full) will be required each year for the first two years. The amount required increases by about 5kg for every successive year, so apply about 15kg in year 3, 20 kg in year 4, 25 kg in year 6 and so on. In eco-san, one option for feeding will be diluted urine. Since urine contains a lot of nitrogen and much less potassium, it is wise to dilute the urine first, and then add a source of potassium. The source of potassium most commonly available is wood ash. As a rule of thumb, most trees, once they have been growing for two years, respond well to a monthly application of a mix of 2 litres urine to 10 litres water (5:1) to which has been added a mug full of dry wood ash and well stirred. This can be applied with a watering can. Several charges of this mix can be added to more mature trees, especially during the rainy season. It helps if the soil around the tree is well mulched.

## Feeding trees with diluted urine and wood ash



The mixture is made of wood ash (a mug full), urine (2 litres), and water (10 litres). For a smaller tree a single change of 2 litres of urine, 10 litres of water mixed with a mug full of dry wood ash is prepared and applied to the soil around the tree. A monthly treatment helps. The ash is added first, followed by the urine, then water.



The water is added next. After stirring, the mix is applied to the soil around the tree. A single application for smaller trees and several applications for larger trees like the mulberry.



This mulberry was planted on a pit filled with human excreta and soil at Woodhall Road, Harare, in August 1989. The photo on the left was taken in December 1989. The tree was fed a 5:1 water urine mix (6 X 12 litres) in May 2002 and 3 X 12 litres (5:1) with wood ash in February 2004. In February 2004 the tree was over 6 metres high. Mulberry trees are perfect for starting an *Arborloo* orchard.



## Influence of urine/water/ash treatment of fruit trees



Photo of mango tree, which had not shown much sign of growth for more than a year. Photo taken 4<sup>th</sup> February 2004. The application of a mix of urine (2 litres), water (10 litres) and wood ash (one mug full – approx 100 gms) started on 4<sup>th</sup> February and continued every 2 weeks during the rainy season, with effective results.



Photos taken of the same tree on 21<sup>st</sup> February (left), showing considerable new growth in response to the urine/water/ash treatment and on 26<sup>th</sup> March (right) where most of the visible growth is in response to the treatment.



New growth of leaf and fruit on mulberry tree (left) and lemon tree (right) following urine/water/ash treatment. The ash increases the proportion of potassium in the mix and helps fruit formation.

## Propagating mulberry trees for use in the Compost Toilet Starter Kit

Mulberry is an excellent tree to start growing on an *Arborloo* pit. It is hardy, can easily be grown from cuttings (in large numbers for distribution) and is tolerant of a lack of watering. It also provides an excellent fruit rich in iron and vitamins A, B and C.

It is also an excellent tree to transport as a cutting in leaf, as part of the **Compost Toilet Starter Kit** (No. 1) which is now being used to promote the simple *Arborloo* concept. This kit is made up of an 8 litre bag of cement (value approx USD 2) one or two mulberry cuttings in leaf and also instructions on slab and *Arborloo* construction and how to plant and look after the tree, first in a pot and subsequently on transferral to the *Arborloo* pit.

The cuttings are taken from an established mulberry tree known for its vigour and tasty fruit, about the size and length of a pencil (see Garden techniques chapter). They are planted in containers or pots so the proximal part of the cutting (nearest the tree trunk) is placed in the soil. The cuttings are then watered and left to grow. The cuttings grow new roots and leaves and also fruits. The cuttings can be grown in individual containers or in basins or larger pots



Mulberry cuttings grown in small individual containers or in larger containers (ten in each)



After two or three months the mulberry twig will grow new leaves and roots and even fruits!





For transit in the COMPOST TOILET STARTER KIT the cuttings can be first wrapped in wet newspaper and then enclosed in a thin plastic bag to retain moisture



The young trees are further protected by rolling them in a cardboard tube for transit. The tube can be placed alongside other parts of the Starter Kit.



The Compost Toilet Starter Kit is made up of 8 litres of cement packed in its own bag which will make a one metre diameter concrete slab when mixed with river sand and water. The Kit also includes simple instructions for making the concrete slab and an instruction manual for the construction and use of the *Arborloo* and care for trees. The two young trees are also included.





The final Compost Toilet Starter Kit has the name of the NGO who provided it or the individual who received it attached to the label. Starter Kit No.1. Kit requires one fifth of a bag of cement, instructions for slab and *Arborloo* construction and use and two small trees. It offers a neat and interesting low cost material incentive for villagers to start off the process of home toilet construction and recycling of the human excreta (in this case by growing trees). Starter Kit No. 2. describes how to build the *Fossa alterna* and make compost for the vegetable garden. This uses one quarter bag of cement.



On arrival at the village or homestead the recipient of the Kit plants the trees in pots or buckets in preparation for later planting in the filled *Arborloo* pit.



Meanwhile the slab and *Arborloo* are constructed following the instructions supplied in the Kit.

## Photo gallery of trees growing on *Arborloo* or organic pits



Mr and Mrs Phiri and Mr Twitty Mukundia of CCAP in Embangweni inspect a paw paw planted on an *Arborloo* pit and well protected against animals. Several fruit trees are growing on a series of *Arborloo* pits in Chiputa Village, Embangweni. Thanks to WaterAid and CCAP.



Citrus trees (orange) growing on *Arborloo* pit in Kusa Village near Kisumu, Kenya (left photo). Note the banana in the background. Bananas flourish on old latrine pits and also *Arborloo* pits.



Trees are amongst Nature's greatest wonders.





A guava tree at Eco-Ed Trust on *Arborloo* pit, Mutorashanga, Zimbabwe.



Planting Variety of trees growing in a sanitary orchard at the Friend Foundation in Harare, Zimbabwe. Indigenous trees of many species will grow on *Arborloo* and other organic pits like this *Swartzia sp* (right photo).



On the left a rampant banana growing on an *Arborloo* pit. In this case the timber structure alternates as an *Arborloo* and a *Fossa alterna*. Earlier in its life the structure was placed at ground level over a shallow pit protected with a ring beam. A banana was planted on the used pit which filled. Later, after a period of flooding, the structure was elevated onto an above-the-ground vault. The vault contents later turned into humus. Banana is planted on old latrine pits in several African countries like Malawi, Mozambique, Kenya and Rwanda. On the right a huge banana plant grows on an old latrine pit in Epworth, close to Harare.





On the left a healthy gum tree grows on an organic pit at the Friend Foundation in Harare. On the right a healthy paw paw tree is growing. In both cases the trees are growing on a mix of dog manure and soil. As with the *Arborloo*, the pit is filled first with a mix of “manure” and soil, and when nearly full is topped up with a good layer of topsoil. The young tree is planted in the topsoil layer. Mulch is added and the tree is protected from animals. It is then watered thoroughly.



Mulberry growing on an *Arborloo* pit at Kafunda Village, Ruwa, Zimbabwe. On the left at the time of planting during an eco-san course for students. On the right about a year later. Mulberry is a versatile fruit tree to grow on *Arborloo* pits. It rarely fails to do well. The fruit is both nutritious and tasty. Young trees can be grown from cuttings, making them easy to multiply.



Trees in all their splendour

## 9. The *Fossa alterna* and the vegetable garden

***We now combine the use of the eco-toilet and the vegetable garden so they can operate with one common aim – to provide more food for the family.***

This chapter describes practical ways of using the eco-humus derived from the *Fossa alterna* and coupling this with other valuable composts and urine to provide more food for the family. To get the most effective production from a small vegetable garden it is wise to take advantage of all these various products if they are available. The small vegetable garden is built to use the materials derived from the toilet with humus being added every year to restore what nutrients the plants have withdrawn. The vegetable garden is linked not only to the toilet, but also to the compost heap, the leaf composting basket and to any source of urine the family can produce. The aim is to bring all these parts of organic gardening together – compost, eco-humus, urine, for the best production of vegetables. Growing vegetables in small containers is also a practical method, especially where space is limited. Buckets or cement basins are ideal.

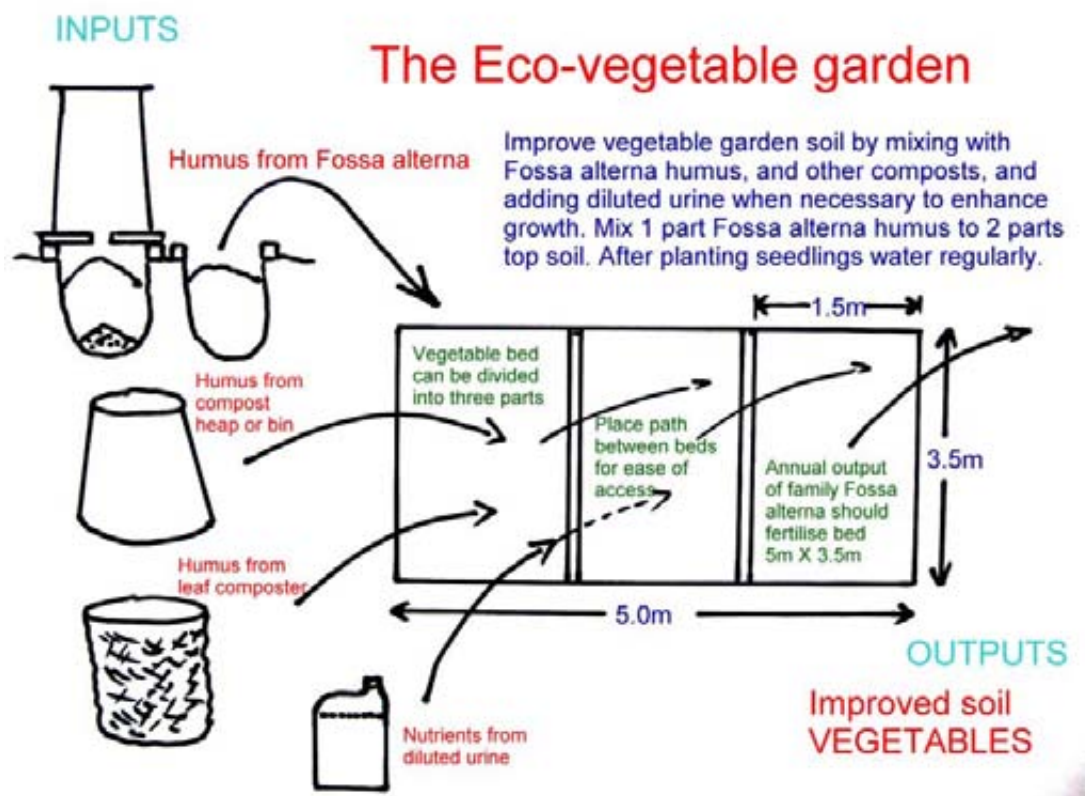

The requirements of the plants must be taken into consideration. Most plants require more phosphorus at first to enhance their root and early shoot growth. Then they require more nitrogen to add vegetative growth. This must be combined with potassium to ensure a healthy plant and potassium is also essential for the fruiting of tomatoes and the best growth of onion, potato and beans. Fruit trees also require plenty of potassium.

So care is required in using the various possible nutrient providers in the best possible sequence. Too much urine at first can stunt the growth of young vegetables which require plenty of phosphorus for their early root growth. Whilst phosphorus is present in urine, the proportion is small compared to nitrogen. The eco-humus has a much more balanced series of

major nutrients and when mixed with topsoil makes an ideal medium in which to plant young vegetables. The generous phosphorus content of the eco-humus is particularly valuable for root and early shoot development of the plant. The eco-humus/topsoil combination alone may be able to support the crop until it is harvested. When extra production is required, especially for leafy vegetables, then urine, mixed with water can and should be applied to the soil. Urine normally takes between 1 and 2 weeks to act and the most obvious effect is for the leaves to turn a darker shade of green and for leaf growth to be enhanced. But the urine must be applied with care. On each 3.5 X 1.5m bed, a weekly application to the soil of 2 litres urine diluted with 10 litres water (dilution 1:5, total volume 12 litres) is adequate for leafy vegetables.

The effect of the eco-humus and also urine on plant growth is very variable, depending much on the existing state of the soil on which it is placed. If the soil already holds sufficient nutrients to provide what the plants require, then the additional effects of adding eco-humus or urine will be less noticeable. Where the soil is deficient, then the effects will be most noticeable. For very poor sandy soils, it is desirable to add more eco-humus, perhaps a ratio of 1:1 with the topsoil, and even better if leaf or garden compost can also be added. Where the soil is part of an existing vegetable garden, then the soil will already have benefited from a certain degree of composting. For vegetable beds use the following sequence:

1. Improve the soil by mixing eco-humus (and compost if available) to the vegetable garden to increase humus content and availability of a good mix of nutrients. Humus which contains plenty of phosphorus is very important at this stage. This is essential for good root growth and also the growth of early shoots above ground level.
2. **Application of eco-humus.** Eco-humus from the *Fossa alterna* can be mixed with the existing topsoil soil at the rate of 2 parts topsoil to 1 part eco-humus on vegetable beds. Using the size of one bed illustrated above (3.5m X 1.5m) the *Fossa alterna* humus is applied to each of the three beds by distributing 12 piles, each of 15 litres over the bed with 0.5m between each pile. Thus 12 piles of 15 litres each can be made over each 3.5 X 1.5m bed. That is a total of 12 X 15 litres = 180 litres. This is about 35 litres humus per square metre of bed. The total annual production of humus from a family (0.5-0.6cu.m.) should be sufficient to distribute over 3 such beds totalling about 15sq.m. Once deposited in a measured way from the buckets, the humus is spread out over the surface with a hoe (badza) and then dug in and thoroughly mixed with the local soil to a depth of about 10cm. This application rate will give an approximate mix of 1 part humus to 2 parts topsoil.
3. If the top soil is very poor and sandy, then the humus should be mixed with the topsoil with a higher proportion of humus. A mix of approximately equal parts of topsoil and humus is best. This can be done by applying about 14 X 20 litre buckets full of humus over each 3.5 X 1.5m bed and mixing in. The annual output of the *Fossa alterna* will then be enough for about 2 X 1.5m X 3.5m beds. Better still to mix the humus with some leaf compost or garden compost and then mix in.
4. If leaf compost or garden compost is available, this can and should also be mixed in too to make a mix of about 2 parts topsoil to 1 part *Fossa* humus + compost (50/50 mix). Thus for each 1.5 X 3.5m bed, 90 litres of humus is mixed with 90 litres compost, making a total of 180 litres, which is then applied to the bed. This is applied with a 15 litre bucket (12 X 15 litre buckets). In fact this will make any *Fossa* humus which is produced go further. With garden compost being available, humus from the



family toilet combined with an equal volume of compost could fertilise up to six 1.5m X 3.5m beds. The overall aim of applying ecological sanitation for the enhancement of vegetable production is to use all the available forms of nutrient rich material to fertilise and invigorate the soil of the eco-garden.

5. This combination of composts and humus, or even humus alone may be quite sufficient to provide all the plant's requirements through to harvest time without any further requirement for liquid plant food (including diluted urine). However, the careful application of urine can enhance the growth of green vegetables further. But over application of urine must be avoided, otherwise the nitrogen and salt content of the soil may rise too high and adversely affect plant growth and health. Regular watering is essential at all times.
6. **Application of urine on vegetable beds.** For leafy vegetables grown on beds (spinach, rape, covo etc), the addition of urine to the bed one month after planting may be beneficial. For each 1.5 X 3.5m bed (5 sq.m.), 12 litres of a mix of 5 parts water (10 litres) to 1 part urine (2 litres), making a total of 12 litres (5:1) can be applied to the soil of the bed once a week. This can be done slowly in a single application allowing time for the liquid to soak in or in two applications of 6 litres spaced a little apart. A third application of water the same day helps to wash off any urine held on the leaves and dilute the urine further. This application should help to enhance green leafy crop production noticeably. But this depends on the fertility of the existing soil. If the soil is already fertile, urine application may not be necessary, and over application may be harmful. If the soil is deficient and *Fossa* humus or compost is not available, then urine may have a noticeable effect. The diluted urine should be applied to the soil directly. If the mix falls on the plant leaves it should be watered down with plain water to avoid burning.
7. It is essential to keep the bed watered at all times and particularly between urine applications. During the rainy season, the rain may be adequate, but artificial watering may also be required. When urine is applied, the additional diluting effect of water will also be required. In any case, watering vegetables is a standard procedure essential to maintain plant health and survival.
8. For crops like tomatoes, potatoes, onions and beans, extra potassium is required, particularly during the second part of the growth cycle, This should be available from leaf or garden compost or from *Fossa alterna* humus. Extra potassium can also be applied in the form of wood ash applied to the soil directly by sprinkling the ash around the plants and digging in. It can also be applied together with diluted urine - a mug full (120gms) of ash per 2 litres urine mixed with 10 litres water. Or 5gms (level tablespoon) ash in 0.5 litres of 5:1 water/urine mix per 10 litre container for every 3 plants. It can also be applied as a mulch of comfrey leaves on soil around each plant. Tomatoes require very special attention and a generous supply of potassium if they are to fruit well (method described later). Fruit trees also require generous potassium to give their best harvests (method also described later).
9. Overall crops will benefit from the addition of leaf mulch and also organic liquid plant foods. These are discussed later. Regular watering and weeding helps to increase the harvest. The weeds compete for plant food, and the less the weeds the more the vegetables.

## **The simple steps for vegetable beds**

1. Prepare a vegetable bed measuring 5m X 3.5m
2. Dig out the humus from the toilet and distribute over the bed evenly
3. Mix in extra compost if available
4. Dig in and mix the added humus and compost
5. Plant vegetables as required
6. Water and weed regularly
7. For extra nutrients add diluted urine to the bed
8. Dilute one part urine (2 litres) with 5 parts water (10 litres)
9. Apply to the soil around the plants once a week  
(this may need 2 or 3 X 12 litre mixes)
10. Use plain water at all other times
11. Green vegetables like rape and spinach like lots of  
nitrogen
12. Tomatoes like lots of potash (wood ash) as well as  
nitrogen
13. Crops benefit by adding leaf mulch
14. Keep the soil dug, weeded, watered and aerated

## Preparing and managing an eco-garden linked to the *Fossa alterna*



Preparing the bed of the eco-vegetable garden. In this case an old vegetable bed is being prepared by weeding, digging down and mixing the soil over an area of approximately 15 sq.m. The vegetable garden was divided into three beds, each of about 5 sq.m. each. In the background on the left photo the humus from the *Fossa alterna* is being dug out. On the right two heaps of *Fossa alterna* humus have been excavated. The 360 litres of humus was divided into two piles of 180 litres each. This volume of humus was sufficient to enrich two of the three beds in this vegetable garden.



Three beds were prepared each 1.5m X 3.5m in area (5.25 sq.m.). The eco-humus was mixed with the existing soil in two of the beds and the same amount of local red topsoil was mixed in the central bed (for comparisons). The humus was applied to each bed by distributing 12 piles, each of 15 litres over the bed with 0.5m between each pile. Thus 12 piles were made over each bed (12 X 15 litres = 180 litres). The humus was spread out over the surface with a hoe (badza) and then dug in and mixed with the local soil to a depth of about 10cm.



This was then spread out over the surface as evenly as possible with a rake. This application rate is thus 180 litres humus to 5.25 sq.m. of bed (35 litres per square metre. If we calculate that the depth of the improved soil is 10cm, the total volume of the mix is 100 litres per sq.m. To make up with 100 litres about 35 litres humus has been mixed with 65 litres topsoil. That is a ratio 2 topsoil (65 litres) to 1 humus (35 litres). A ratio of 2:1. After watering, the seedlings are planted. In this case spinach and rape. 50 plants were sown in each of three beds making a total of 150 plants.





**An example of the eco-vegetable garden just planted with seedlings with the *Fossa alterna* toilet behind. On the right another view from the toilet side when the vegetables were growing. A family should provide enough excreta, when combined and composted with soil, leaves and wood ash to make 0.5 – 0.6 cu.m. eco-humus per year. This is enough to apply to an eco-garden 3.5m X 5m.**



**After 4 weeks a good harvest of green vegetables has grown ready for the first cropping. Spinach and rape can be harvested at least twice and covo several times. On the right spinach plants look very healthy.**



**The first crop of spinach and rape being harvested at 4 weeks. The vegetables in this case were prepared for sale in neat bundles. Further crops can be harvested. When the crops are finished, the old plants are removed and the soil dug down and aerated. Additional compost can be added if required. New seedlings are then planted. The vegetable garden is maintained in the same way as any other vegetable garden.**

**Regular weeding and watering is essential to obtain maximum crop output. Research work on eco-gardens linked to the *Fossa alterna* continues.**



## Using *Fossa alterna* humus in the flower bed

*Fossa alterna* humus can also be used to enhance all soils including those used for ornamental purposes in flower beds. This may be the preferred method if there is some resistance at first to applying the humus on to vegetable beds. The same technique is used as on the vegetable beds. Humus from the toilet, once well composted can be applied with a bucket to the soil, at the rate of about 35 litres humus per square metre soil. Humus can be held in sacks before application, and this tends to improve the quality and safety of the product, since it involves aeration, turning and greater storage. The new humus is spread out and then mixed in with the existing topsoil, making a new soil which is more organic and fertile. Seedling flowers can then be sown and the resulting colour will be a great pleasure for the householder. Once established, urine can also be applied to the beds by mixing with water (10:1) and apply weekly in a watering can. Nutrients derived from human excreta can assist in the growth of all plants – and that includes flowers and other decorative ornamentals.



The *Fossa alterna* humus is carried to the bed in buckets and spaced so that about 3 to 4 ten litre buckets of humus covers a square metre of bed area. The piles are then spread out and mixed with the existing topsoil with a hoe.



The Dutch hoe is a fine gardening tool and valuable for many jobs of the vegetable or flower bed. Here it is used to mix the new humus with topsoil.



The new bed with enhanced growth of flowers

## Growing vegetables on containers

Several types of vegetables can effectively be grown in containers – either 10 litre buckets or basins. The most economical way of making the basins is to use a plastic basin as a mould and to cast replicas in concrete with cement and sand. These turn out to be more durable and cheaper per unit than the original plastic basins. About 50 X 10 litre basins can be made with a single bag of cement. The method of making cement basins is described in a later chapter.

Once again the success of growing vegetables in containers much depends on the soil itself. The better the soil, the better the result. Containers may be a convenient way of growing vegetables if space is limited, but this will rarely be the case where ecological sanitation is used. But containers do have other benefits and some disadvantages. The benefits are that the soil can be well chosen and mixes of *Fossa alterna* humus and topsoil may go a long way. The soil can be used for the crop and then later moved to a soil recycling pile and fresh soil added for the new crop. Thus a supply of recycled and rejuvenated soil can be used. The disadvantage of container gardening is that the soil volume is small – often only 10 litres. Thus the supply of nutrients in the 10 litres of soil is finite and limited. This means that a supply of nutrients, best applied in liquid form, must be supplied to get the best production of crops. Also the quantity of water available in 10 litres of soil is also finite and limited and basins of vegetables need far more frequent watering than vegetable beds. So in practice, vegetables growing in containers need a more constant supply of plant nutrients and a regular supply of water. The use of containers is thus ideally suited to the application of liquid plant foods including diluted urine.

### For 10 litre containers use the following sequence:

1. *Fossa alterna* humus can be used unmixed with other soils, as in the case of tomatoes grown in containers, but it is best mixed with other soils or composts. Prepare planting soil using a mix of topsoil, *Fossa alterna* humus and garden or leaf compost if available to get plenty of humus. A 50/50 mix of *Fossa alterna* soil and topsoil (5 litres of each) is suitable. Or make up 40 litres in a wheel barrow using 20 litres topsoil, with 10 litres *Fossa alterna* soil and 10 litres garden or leaf compost. Mix thoroughly and add 10 litres of the mix to each basin.
2. The seedlings should be prepared beforehand. If possible plant seeds in seed trays and water regularly. Leaf compost liquor (see later) can also be used for watering seedlings. When two or three weeks old transfer seedlings to the 10 litre basins, at the rate of three plants per basin for plants like spinach, rape and covo. For tomato which is best grown as a single plant in a 10 or 15 litre bucket, plant in a mix of *Fossa alterna* humus, topsoil and compost if available. For good drainage the final soil mix should be crumbly and humus like.
3. Keep young plants watered and under shade out of hot sun (containers can be moved) for one to two weeks before applying any diluted urine.
4. When plants are well established the application of diluted urine can begin. If leaf compost liquor has been used for seedlings this can be continued. The liquor is more balanced but has less nitrogen compared to the diluted urine. A ten litre container will accept about 0.5 litres of plant food per application.
5. Liquid plant food like leaf compost liquor can be applied at the rate of 0.5 litres per container at least twice a week with all other applications being water only. Liquid plant food can be obtained in several ways. One is to drain water over composting leaves, including urine fed comfrey leaves. The resulting liquor (which looks like tea) can be watered directly on the soil without dilution. It has a good balance of nutrients and a very positive effect on plant growth. Its effect is milder than diluted urine, but produces succulent green vegetables. Such liquor can be applied to containers for long periods without the fear of over nitrification or salt build up.



6. Urine diluted with water can be applied at various dilutions and rates to containers. The stronger the mix (say 3:1) and the rate (say 3 times per week) the more pronounced the growth of the plant will be - up to point. But over application can be harmful to plants. Plants will survive quite a strong application in the short term provided water is also added regularly to the basin to maintain plant health. This can produce an impressive result in the short term, say over one or two months for green vegetables like rape and spinach. But care is required. Although plants like rape, spinach and covo can accept an application of urine diluted with 3 parts of water, up to three times a week (0.5li application per 10 litre container), this may lead to weakening of the plants within 2 months due to potassium deficiency caused by the over application of nitrogen in the urine. But too little urine will have little effect. On rape, for instance, a 5:1 mix applied once per week may have little effect, especially if the soil has not been fertilised before. So a good balance is required and adjusted through the life of the plants.
7. 0.5 litres of a 3:1 mix of water and urine applied twice a week will provide 0.25litres of urine per week per basin (normally containing 3 plants like rape or spinach). A 5:1 application twice a week will provide 0.166 litres of urine a week. A 3:1 mix once a week will provide 0.125litres of urine a week. A 5:1 application once a week will provide 0.083litres of urine a week. Compared to the 5:1 application, once per week, the 3:1 application once per week provides 1.5 times the urine, the 5:1 application twice per week provides 2 times the urine and the 3:1 application twice per week provides 3 times the urine.
8. **A good standard procedure for green vegetables like rape and spinach growing in 10 litre containers is to apply a 3:1 mix twice a week for the first month, with intermediate watering. Reduce this to a 5:1 mix twice a week for the second month with intermediate watering. From then on apply a 5:1 mix once per week with intermediate watering.** A 3:1 mix can be made up with 2 litres of urine and 6 litres of water in a 10 litre bucket. A 5:1 mix can be made up with 2 litres of urine and 10 litres water in a 20 litre bucket. The diluted urine can then be applied to the soil in the container with a 0.5 litre jug. The best rate to suit the individual gardener can only be discovered with experience.
9. **Also for longer term onion (6 months to harvesting) in basins, apply a 3:1 mix twice a week for the first month, with intermediate watering. Reduce this to a 5:1 mix twice a week for the second month with intermediate watering. From then on apply a 5:1 mix once per week with intermediate watering.** The diluted urine is applied with a 0.5 litre jug to each container. Onions also benefit from wood ash being added.
10. **Tomatoes (3 – 4 months to harvesting) grown in buckets do not require an excess of nitrogen. Only apply diluted urine after the first small fruits appear. Then apply 0.5 litres of 5:1, once per week. Tomato like lots of potash. It is also best to add wood ash by digging in a tablespoon per week to the bucket soil and watering in.** Plant food using liquor derived from composted comfrey & other leaves also helps to give good crops of tomatoes (see later).
11. Normal watering of vegetables in containers should continue at all times. In hot dry weather water may be required 2 or 3 times per day in basins, but under different conditions a daily application may be enough. If the plants begin to wilt, then the time is overdue for watering.
12. Liquid plant food (such as leaf compost liquor passed through composting comfrey) may be best for tomatoes, where a subtle balance of nutrients is required. Extra potassium can also be applied as wood ash and extra phosphorus as single super-phosphate (see later).
13. Weeding is always an important part of the gardening process, and weeds should be kept down in the basins as well as on the larger beds. The plants benefit from regular weeding which also aerates the topsoil. Mulching with leaves also helps a great deal, especially in containers.
14. When the plants have been harvested to their full extent (several croppings are possible from plants like spinach), the old plant stumps are discarded and placed in the compost heap. The basin soil can also be moved on to a pile and mixed with other soils to rejuvenate. It can later be reintroduced back into the basin. Alternatively, the existing basin soil can be loosened up and mixed with fresh soil, compost or humus before planting begins again.
15. Containers can be used to grow a variety of vegetables including rape, covo, spinach, onion, tomato, beans, maize, strawberry, etc. Tomatoes are best grown in 10 litre buckets. Rape, spinach & onion are best grown in basins. The concrete basins, when carefully made, can last almost indefinitely, and thus are a good investment in time and money.

## The simple steps for growing vegetables in containers

1. Prepare the containers (10 litre buckets or cement basins)
2. Prepare the soil for the containers. A mix of *Fossa alterna* soil, compost, leaves, and topsoil is good. Or any fertile soil.
3. Grow the seedlings from seed in beds or seed trays
4. After a few weeks, when the seedlings are ready, transfer to the containers. For rape and spinach and covo, 3 seedlings per 10 litre basin. For onion up to 10 per basin. For tomato 1 per 10 or 15 litre bucket.
5. Water the seedlings with plain water for a week to establish
6. Plant food in the form of a urine/water mix can be applied to the basins at the rate of 0.5 litres per container, once or twice a week
7. For green vegetables like rape, spinach and covo apply:  
  
For first month use 0.5 litres of 3:1 (6 litres water + 2 litres urine)  
twice a week  
For second month use 0.5 litres of 5:1 (10 litres water + 2 litres urine)  
twice a week  
For third month and thereafter use a mix of 5:1 (10litres water + 2 litres urine)  
once a week
7. For Onion use same water/urine application as above.
8. For Tomato use liquid plant food from leaf compost with comfrey or 0.5 litres of 5:1 water urine once per week only after fruit formation. Add wood ash to the bucket soil (1 tablespoon ash per bucket, every week).
9. Water and weed often. Leaf mulch helps in containers.
10. When crop finished recycle soil in heap, bring in new soil for new seedlings.

## Examples of successful vegetable production in containers.

### 1. Growing plants on neat *Fossa alterna* humus

Several types of plant can be grown on unmixed, neat humus from the *Fossa alterna* pit. Here are some examples with plants growing on containers.

#### Green pepper

Green pepper is a valuable crop and can be grown on neat *Fossa alterna* humus or *Fossa* humus mixed with topsoil in buckets. However the best way is to mix the humus with garden or leaf compost. Pepper is normally grown in beds. When grown in containers the application of additional liquid feed also helps, like diluted urine.



Green pepper growing on buckets of undiluted *Fossa* soil (left), poor Ruwa soil (right) and a 50/50 mix of the two (centre). A 20 fold increase in yield from poor to rich soil

#### Sugar Bean



Sugar bean is a valuable and popular crop. Early trials show it grows well on both neat *Fossa alterna* humus and humus mixed with other composts and rich top soils. On the left sugar bean growing on neat *Fossa* humus on 23<sup>rd</sup> February - on the right same plant 30<sup>th</sup> March. However signs of nutrient deficiency are showing up in the earlier yellow leaf. Growth is enhanced by the application of diluted urine (5:1, twice a week) – see next chapter.



## 2. Effect of enhancing poor topsoil with *Fossa alterna* humus in containers

Most soils in this part of Africa are very deficient in nutrients and unless fertilised in some way, produce very poor yields. The fertility of poor soils can be increased significantly by adding compost and also cow manure, and these methods are often practiced and should be encouraged more. However, cow manure may not always be available, especially where people live in the peri-urban fringes. On this page you can see the effect of enhancing very poor soil (taken from Epworth) with *Fossa alterna* humus. In each case shown, the very poor topsoil was mixed with an equal volume of *Fossa alterna* humus (5 litres + 5 litres). The increase in growth is very significant. Poor soils, such as those used in the trial are very common in Africa. By combining poor soil and eco-humus, vegetable production can be enhanced significantly. Output of onion and leafy vegetables can be increased further by applying diluted urine in addition to eco-humus (see chapter 10).



**Left Photo:** The photo shows spinach grown on poor soil (from Epworth) in left bucket compared to spinach grown on the same poor soil mixed with an equal volume of *Fossa alterna* soil (right bucket) after 30 days of growth. The harvest was increased 7 times (546 gms compared to 72 gms).

**Right Photo:** The photo shows covo grown on poor soil (from Epworth) in the left bucket compared to covo grown on the same poor soil mixed with an equal volume of *Fossa alterna* soil (right bucket) after 30 days of growth. The harvest was increased 4 times (357gms compared to 81 gms)



**Left Photo:** The photo shows lettuce grown on poor soil (from Epworth) in left bucket compared to lettuce grown on the same poor soil mixed with an equal volume of *Fossa alterna* soil (right bucket) after 30 days of growth. The harvest was increased 7 times (912 gms compared to 122 gms).

**Right Photo:** The photo shows onion grown on poor soil (from Epworth) in the left bucket compared to onion grown on the same poor soil mixed with an equal volume of *Fossa alterna* soil (right bucket) after 4 months of growth. The harvest was increased nearly 3 times (391gms compared to 141gms). Whilst this a significant increase in onion production, the best crops are produced on very rich organic soil. Onions are hungry feeders. See next chapter on use of urine.

## 10. The usefulness of urine

Urine has been used as a valuable plant food for centuries in many parts of the world, particularly in the Far East. It is surprising therefore that nearly all the urine produced in the West and in Africa goes to waste and is lost to agriculture. Each of us passes about 1.5 litres of urine every day - and almost to the last drop, it is either flushed down a toilet or enters a deep pit latrine. The fact is that urine is a very valuable product - in several ways. It contains a lot of nitrogen and also phosphorus and potassium in smaller quantities, nutrients which are very valuable to plant growth. Simply put, urine is too valuable to waste.

The nitrogen found in abundance in urine is good for plant growth because it helps to build protoplasm, protein and other components of plant growth. It certainly promotes leafy growth. Leaves become more numerous, go greener and larger and more fleshy with urine application. Phosphorus is important in the root formation, ripening of fruits and germination of seeds, although the percentage of phosphorus compared to nitrogen in urine is low. Potassium is also essential for promoting good fruit (and flower) development. Plants differ in their requirements, but overall plants fed with some urine grow better than plants which never come into contact with urine. Urine is particularly valuable for grasses like maize and leafy green vegetables, and onions, which respond to the high nitrogen content of urine.

### Urine as a plant food

When applied to the soil the urea (a small organic molecule) in urine changes into ammonia ions which can be transformed into ammonia gas, which can evaporate and be lost or, in the soil, can be converted by autotrophic bacteria (*Nitrosomonas*) into nitrite ions and then *Nitrobacter* into nitrate ions which can be taken up by the plant. The conversion is thus dependent on these bacteria being in the soil. The process takes place in less than two weeks and often within a few days. It is the nitrogen in the nitrate and the ammonia ions which are available to plants, thus the urea in urine must be transformed before it becomes useful as a “plant food.” The nitrite ions, present during the conversion, can be toxic to plants, but the period is brief and normally there is little effect on plant growth.

The proportion of useful plant nutrients in urine will vary a little. According to Wolgast (1993) one litre of urine contains 11gms nitrogen, 0.8 gms. phosphorus and 2 gms. potassium. That is a ratio of NPK of about 11:1:2. If 500 litres of urine are produced by each person per year, that amounts to the equivalent of 5.6 kg nitrogen, 0.4 kg phosphorus and 1.0 kg potassium. The actual amounts of these minerals will vary from one person to another and also from country to country depending on the national diet. The more protein consumed, the more nitrogen is excreted. Thus in dealing with urine as a potential supplier of plant nutrients, one must accept that it has a very high, but variable level of nitrogen (and also common salt). The ratio of the main plant nutrients (NPK) is approximately 11:1:2, which is not ideal for growing most plants, especially in the early stages of their growth.

Most vegetable fertilisers in Southern Africa contain more phosphorus than nitrogen. In an assessment of 10 garden fertilisers available in Zimbabwe, the combined ratios of NPK amount to N = 98 points, P = 174 points and K = 125 points a ratio of very approximately 1:2:1. Compound vegetable fertilisers often have a ratio of 2:3:2 for NPK. Ammonium nitrate is quite often applied separately as a “top dressing” once the plant is established. The recommended fertilisers for maize provide more phosphorus than nitrogen in the ratio 1:2:1 at

the planting or seedling stage and then ammonium nitrate at a later stage once the roots have been established and the plant is secure and meaningful vegetative growth has already taken place. The high phosphorus content of these chemical fertilisers not only reflects the needs of the plant at an early stage of their life, but also that most soils in Africa are very deficient in phosphorus. 70% of natural soils tended by rural farmers in Zimbabwe are very deficient in phosphorus. It is interesting that studies in China show that the daily output of phosphorus in the faeces is greater than in the urine.

The balanced array of nutrients present in eco-humus is thus ideal for the early growth of plants with more phosphorus in relation to the other major nutrients, compared to urine. Later on urine can be applied as a liquid plant food during the main vegetative period of growth to supply extra nitrogen. Nitrogen loving plants like maize and green leafy vegetables are particularly responsive.

Also, according to Hill (1997) an excess of nitrogen can reduce the uptake of vital elements like potassium, which is an essential nutrient for healthy plants. Hill also explains that if you fill the plant transpiration stream with a salt and only a fraction gets used, then other more important nutrients may get blocked. The uptake of too much phosphorus may block potassium, whilst excess calcium locks up boron (Hill, 1997). It is not uncommon for magnesium to be deficient where chemical fertilisers provide lots of potassium. The answer to all these problems is to try to accomplish a balance of nutrients in the soil. It is also accepted that unless plants have plenty of humus in the soil, they cannot take up the minerals even if available, especially in drier conditions, a conclusion arrived at by Bromfield (1949) as well as Hill (1997) and many others.

The functions of nitrogen, phosphorus and potassium are interlinked. If large amounts of nitrogen are used, this will cause extra leaf and stem growth, but this growth response will cause the plant to demand extra phosphorus and potassium from the soil. Extra that is to the amount which would have been needed without the nitrogen application. Also nitrogen cannot be efficiently used by the plant unless potassium is there in a proper N/K ratio. Thus deficiencies in phosphorus and potassium show up if too much nitrogen is applied. Nitrogen is a primary growth nutrient, but without the accompaniment of adequate phosphorus and potassium the growth is unhealthy, more liable to pest attack and disease. Potassium in particular is needed to bring about a balance and ensure that the extensive plant structure is formed of healthy and efficient tissues. This imbalance is perhaps not so serious in short lived plants like lettuce (and green vegetable like spinach and rape and covo). But where the plant has to grow for a full season and eventually produce a seed or fruit crop, these derangements caused by unbalanced nitrogen become serious. Apart from the danger of pest attack and disease, the overstraining of the tissue building function leads to delay in the other functions of the plant and the seed formation or fruit ripening stages are held up.

According to Hopkins (1945) anybody wishing to demonstrate this by personal experience should see how much is lost by giving one or two tomato plants in a row, applications of soluble nitrogen in the late (European) summer. Further leaf and shoot formation will occur but the existing fruit will delay their yellowing and reddening until the autumn sunshine has departed. The fruit yield is thus reduced.

Thus a good balance of nutrients is required for the best plant growth, with generally more phosphorus being required at first in relation to the other major nutrients and then more nitrogen and potassium required later. Adequate amounts of potassium are particularly



necessary for crops like tomato, potato and also fruit trees. Too much nitrogen can block this vital element. So care is required in the overzealous application of urine.

The balance of nutrients available in urine can be influenced by various means. The addition of plants and other materials to form a liquor which is allowed to ferment in urine, can change the balance. Thus the fermenting of comfrey leaves in urine is known to increase the proportion of potassium in relation to nitrogen (Hill, 1997) – see description in gardening techniques. It is also possible that the peels of fruits like banana, which are known to be high in phosphorus, potassium, calcium, magnesium and sulphur and citrus peels, known to be high in phosphorus and potassium, if allowed to ferment in urine, may readjust the balance of nutrients (a possibility which has yet to be tested). Diluting the lower fraction of urine which has been allowed to sediment out (with the salts containing phosphorus being held in the sediment) may also adjust the balance of nitrogen and phosphorus increasing the phosphorus in relation to nitrogen. But the simplest answer lies in preparing the soil well first with humus and compost, and then feed later with urine in the amount required for specific plants.

### **Methods of collecting urine**

By far the simplest method of collecting and storing urine is for men to urinate in bottles when they visit the toilet. There are several other methods which can be used - the “desert lily” concept is one - where a funnel is mounted over a plastic drum in some position which allows the passing male to urinate in privacy. The simplest are funnels mounted over 20 litre plastic containers. Piping, fittings and containers should be made of plastic - the urine is very corrosive – metal will corrode badly. The urine diverting pedestal is also another suitable method for collecting urine. These pedestals are commonly used in ecological sanitation projects all over the world. There are variants which allow for squatting as well as sitting. The urine diverting pedestal has a pipe which can be used to convey urine into a storage vessel like a 20 litre plastic drum. Care must be taken to ensure than faecal matter does not enter the urine section. Pedestals mounted over removable buckets can also be used to collect urine - they are useful for women. “Potties” filled at night in the bedroom can also collect urine – a well established method. Urine collectors can also be made which fit into conventional flush toilets, the urine being decanted into plastic bottles. Once the urine is collected - it is stored in plastic containers which are capped before use or processing.



**Collecting and storing urine in bottles is the easiest way for men. On the left urine stored in discarded two litre milk bottles. A funnel placed over a 20 litre plastic container is also effective if well placed in some private location. It is a type of “desert lily.”**



On the left a 10 litre bucket is placed beneath a pedestal which helps women to collect urine. On the right a urine collector shaped from a plastic bucket is used to collect urine from a standard flush toilet.

## Storage

Urine can be stored in bottles (2 litre plastic milk bottles for instance) or containers for long periods provided they are well capped and the ammonia is not allowed to escape. Deposits of the phosphorus and magnesium salts will be deposited however on the base and side walls of the container. It is possible to place a small flexible tube through the side wall of a 20 litre plastic container and allow the phosphorus laden sediments to settle out. Decanting the upper half may produce a product which has a higher proportion of nitrogen in relation to phosphorus. Shaking and stirring the remaining urine in the lower half of the container may produce a liquor with a higher proportion of phosphorus, released from the sediments of calcium phosphate and magnesium ammonium phosphate, once stirred and shaken. Once stored, urine usually turns darker. The exact constituents of urine vary from one person to another.

## Uses of urine in agriculture

There are at least five ways of using urine for the benefit of agriculture. These are:

1. Urine applied to soil without dilution before planting
2. Urine applied to soil without dilution near the young plant, followed by watering
3. Urine applied to soil - diluted with water – to the growing plant
4. Urine as an “activator” for compost.
5. Urine as a medium for fermentation of plant residues

### 1. Urine applied to soil without dilution before planting

Urine can be applied without dilution to the topsoil of vegetable beds during the preparation stage, before planting. Later, after several weeks the vegetables are planted and watered normally and their growth will be enhanced. During the months after urine application, soil bacteria convert the urea into ammonia, then into nitrite and finally into nitrate which the plant can absorb. Heavy rain can flush the nitrates away, a risk also with some potassium salts, although to a lesser extent. The far less soluble salts of phosphorus tend to hold their place in the soil far better.

## **2. Urine applied to soil without dilution near the young plant, followed by watering**

Urine can also be applied without dilution to the soil near a plant and then diluted with either further applications of water or with rain water. Most plants will die if undiluted urine is applied directly to the roots of plants in the soil, so the urine must be applied to the side of the plant. Dilution in some form with water is required if applied directly to plants. Also some of the nutrients in urine are not immediately available to the plant as “food” - they must be converted first. As has already been discussed, nitrogen for instance, must be converted from urea into ammonia, then to nitrite and finally into nitrate salt which is available to the plant. Fertile soil, containing a higher number of beneficial soil bacteria are more effective at converting the urine than poor sandy soils which contain fewer bacteria. For this reason urine is best applied to soil containing humus. If diluted urine is added to a very poor soil on a prolonged basis, particularly sandy soil, the young plants will gain the nutrients and grow better than on poor soil without urine (see later maize trials), but the plant growth will never equal that on poor soil to which humus has been added. So if the soil is really poor, it is best to add humus first to get the best effects of urine.

## **3. Urine as a liquid plant food - diluted with water**

Perhaps the most obvious way of using urine is to dilute it with water and apply the mixture to the soil in which plants are growing directly. The urea must go through the same conversion as it does when applied without water - so the effects of urine/water application are not immediate.

The age of the plant and the condition of the soil are important. If the soil is poor and sandy for instance - the application of urine may stunt plant growth and even kill off the young plants even when diluted with water. So care is required. Where the soil is more humus like, then the urine can be applied with greater success. Humus application to sandy soil - seems to be very important if urine is going to be used effectively.

Obviously more mature vegetables can cope with a higher concentration of urine and water than young seedlings. The nitrite stage of urine conversion is actually toxic to plants. If seedlings of plants like tomato, rape and spinach are watered constantly with urine diluted with water (both 3:1 and 5:1 water/urine mix) the growth of the seedlings will be retarded, compared to identical plants which are irrigated with water only. The young plants may not die, but their growth is much slowed down. Thus the constant daily application of urine, even when diluted with water is not recommended. Remarkably, plants stunted by an overzealous application of water/urine will later recover when water alone is applied. Perhaps this is because the excess nitrogen can be flushed out and the soil itself has built up a reserve of basic nutrients (like phosphorus and potassium) which can then be used by less stressed plants. It is possible that in flushing out the nitrogen levels are much reduced leaving more phosphorus, which binds better with the soil, which is what the roots need to grow.

A range of dilutions of urine with water seems to work. A simple recipe which seems to work well for many plants is to use urine diluted three parts of water (3:1). This dilution appears to be well tolerated by plants from seedling stage, provided that the treatment is interspersed with regular normal watering. Such a mix is applied once, twice or even three times per week (see later) for use on a variety of vegetables and crops. To repeat, the application works if all other irrigation is applied using water only. Thus the initial water/urine treatment is diluted much further by more watering. Plants cannot sustain constant watering with the 3:1 mix



alone. The build up of salt (NaCl) and nitrogen would be too great and lead to stunting or death of the plants. The results of plant trials show that this mix of water and urine will considerably enhance the growth of green leafed vegetables when applied twice or three times during a week, interspersed with normal watering at all other times. For increased economy of urine the rate of application can be reduced to once or twice a week application of 3:1 or the dilution can be changed to 5:1 with reduced effect.

This dilution method is the one practiced by the writer and with much success. In practice a 2 litre bottle of urine is diluted with three or five times the amount of water in a 10 litre bucket. This water is drawn out with a jug which holds 0.5 litres of the mix and is applied to the vegetables in 10 litre containers, twice a week. This is an ideal recipe for growing vegetables in 10 litre buckets or cement basins. The soil in the container can be selected beforehand to give the best results. A mix of composted soil and leaf mould is ideal.

### **Examples of successful vegetable production in containers.**

Vegetables like covo, rape, spinach and several other green leafy vegetables can adapt to a wide range of urine applications when applied to containers provided that water is also applied liberally. In fact in the case of vegetables and other plants grown on containers, which hold a relatively small volume of soil, it will always be necessary to apply water regularly to sustain plant health, since the volume of water held in the soil is small. On a hot day, the plants will wilt easily, and require frequent watering. With such a constant throughput of water, diluted urine can be applied as frequently as 3 times per week. For use on containers, urine can be diluted with water at the rates of 3:1 or 5:1 and applied once, twice or three times a week. Where there is a large throughput of water in containers it is best to apply in small doses more often than bigger doses less often. Experience has shown that provided fresh water is added to the basin frequently, green vegetables can withstand the 3:1 and 5:1 applications without harm. Generally the rate of growth of green vegetables is in proportion to the amount of urine applied. However in the longer term, a build up of salt occurs, and there may be an excess of nitrogen which will inhibit the uptake of potassium.

For these reasons it is wise to empty the containers of soil treated with urine and remove them to a compost site where the soil can be mixed with other composts and soils and watered without urine application. Thus the soil can be restored and invigorated.

**A good standard procedure for green vegetables like rape and spinach growing in 10 litre containers is to apply a 3:1 mix twice a week for the first month, with intermediate watering. Reduce this to a 5:1 mix twice a week for the second month with intermediate watering. From then on apply a 5:1 mix once per week with intermediate watering.**

**For tomatoes grown in buckets only apply diluted urine after the first small fruits appear. Then apply 0.5 litres of 5:1, once per week with wood ash (add a tablespoon per week to the bucket soil and watering in).**

**Also for longer term onion (6 months to harvesting) in basins, apply a 3:1 mix twice a week for the first month, with intermediate watering. Reduce this to a 5:1 mix twice a week for the second month with intermediate watering. From then on apply a 5:1 mix once per week with intermediate watering.**

## Preparing the urine/water mix



General equipment required for applying urine. Various buckets, watering can, rubber gloves and 0.5 litre jug for dispensing the mix. Supply of urine (in 2 litre plastic bottles). A 5:1 mix can be made with 2 litres of urine and 10 litres water. A 3:1 mix can be made with 2 litres of urine and 6 litres of water.



Add the 2 litres urine first to a larger (20 litre) bucket, then add 10 litres water from the 10 litre bucket.



Apply to the containers from a 0.5 litre jug or similar container. Once or twice a week depending on duration of application. For shorter term (1 – 3 months) on green vegetables, twice a week with plenty of watering in between. For longer term (3 – 6 months) the mix should be applied once a week with plenty of watering in between (tomatoes and onion).

In some applications additional sources of nutrient are mixed in with the urine/water. Like extra phosphate or wood ash applied at the rate of 5gms per 0.5 litre charge of urine and water (5:1). The wood ash supplies extra potassium, particularly suitable for tomatoes.





Mixing in extra wood ash to the jug. 5 gms (level tablespoon) ash per 0.5 litres of 5:1 application. The ash helps to make plants more healthy and is good for fruiting. In this case it is being applied to spinach in an experiment. This type of application is particularly good for tomatoes.

## RAPE

Rape is one of the most popular vegetables grown in Zimbabwe. It is used a great deal in relish eaten with maize meal in combination with onion, tomato and meat. It responds well to being grown in containers which are fed urine diluted with water. In this trial, rape was fed diluted urine (3:1) twice a week. The urine application led to a 5 fold increase in harvest after 28days. This is an excellent response to urine.

Plant	Liquid plant food	frequency of application	weight harvested
Rape	water only	normal watering	160 gms (9 plants)
Rape	3:1 water/urine	0.5 litres 2 X per week	822 gms (9 plants)



Left: Photo shows 3 basins (on left) which were water fed and on right 3 basins fed with a 3:1 water/urine mix, twice a week. The effect only became noticeable after 10 days treatment. After 28 days water/urine application the effect is very noticeable (photo on right with water treatment below and urine treatment above). Some of the basins are obscured. Rape yield was increased about 5 times.





Left: The relative yields of water fed and water/urine fed rape grown on 10 litre basins after 28 days application. The plants have just been harvested for the first time. Right: the same plants almost a month later just before the second crop was harvested. Yellowing and mauve colour on some leaves begin to show after 2 months of urine application at this rate, indicating that the plants are beginning to weaken. This is probably due to over application of nitrogen from the urine. Longer trials like this provide the best indications of the most suitable water/urine treatment under these conditions. A weaker 5:1 application given to the plants once a week may be better in the longer term

## Spinach

Spinach is another popular vegetable in Zimbabwe. Like rape, several harvests can be taken from the same plant over a period of several months. It is ideally suited for growing in containers which are fed diluted urine as shown below. During the first month, the urine application (3:1, twice per week) led to a 3.4 fold increase in harvest after 28 days, compared to water fed plants. This is an excellent response to urine. During the second month the urine dose should be reduced to 5:1, twice a week and during the third month and after, the urine dose should be reduced further to 5:1, once per week. 0.5 litres of the diluted urine is applied to each basin per treatment. The plants are watered at all other times.

Plant	Liquid plant food	frequency of application	weight harvested
Spinach (22plants)	Water only	normal watering	741 gms
Spinach (22plants)	3:1 water/urine	0.5litres 2 X per week	2522gms



Photos taken of the 16 basin spinach trial. Basins to the left of the green band are urine fed, those to the right water fed only. Photo on left taken on 3<sup>rd</sup> December 2003 on the first day of urine treatment. Photo on right taken on 31<sup>st</sup> December 2003, 28 days after first urine treatment. The effectiveness of the urine treatment is very positive and very clear to see. Urine fed 3.4 times water fed.



Left: The total collected harvest of urine treated spinach on the left and water treated spinach on the right after 28 days of urine treatment (3:1, twice per week). Right: plants fed water/urine during their second month are beginning to lag behind plants fed the 3:1 water/urine mix for the first time. The best yield however is being produced by plants shown on the four basins to the right, which have been fed only two applications of the urine water mix and then leaf compost liquor under a mulch of leaves. These signs show that if urine is to be used as a liquid plant food over a prolonged period, the dose should become weaker as the time is extended. For spinach – first month 3:1, twice a week; second month 5:1, twice a week; third month and thereafter 5:1, once per week. Extended trials show that the lower dose can maintain spinach output, once the soil has been well fertilised by prolonged and correctly applied urine treatment. 0.5 litres of the diluted urine is applied to each basin per treatment. The plants are watered at all other times. Spinach responds very well to this type of treatment.

## Onion

Onions are well suited to growing in containers and also respond positively to the application of diluted urine. Onions do take a long time to grow, between 6 to 8 months being required between planting seedlings and harvesting. Seeds are best planted during January or February (for Southern Africa) and allowed to grow in seeds trays. They are transplanted into cement basins when about 4 – 6 weeks old. During this period they can be fed with leaf compost liquor. After transplanting, a weekly application of a urine/water mix (1:5) will help the onion considerably and can begin a week or two after transplanting. Onions need good supplies of nitrogen as well as phosphorus (in the early stages) and plenty of potassium later on. The application of wood ash will help. Planting on a mix of *Fossa alterna* humus will help, even better if mixed with compost. A good leaf mulch will help the supply of phosphorus and potassium. The application of leaf compost liquor will also help.



Up to ten onion can grow in a single 10 litre cement basin. Onion are first grown in seed trays, then transplanted to basins. These onion were fed a 3:1 water/urine mix, once a week. They were planted as seedling on 17<sup>th</sup> May and reaped about 6.5 months later on 27<sup>th</sup> October 2003. An average of 1 kg of onion was reaped from each of ten jars planted. The number of plants varied between 5 -9 plants at harvest with weights per basin varying from 0.7kg to 1.3 kg. The growth was improved by the application of a mulch made of leaves. This reduced weeds and also provided some nutrients as well as reducing water loss from the soil. The basin and urine method appears to suit onion.





Some very good looking onion can be grown in cement basins with the help of a water/urine feed. Here two prize specimens! Onion seeds are best planted early in the year, late January or February being good times, so they can be transplanted into containers towards the end of the rains in April. The healthy onion on the right was harvested in early September after 6 months of water/urine treatment in a 10 litre cement basin. 0.5 litres of a 5:1 mix of water had been applied once a week for all that period together with intermediate watering. Such a result reveals the usefulness of urine as a plant food.

## TOMATO

Tomato seedlings will grow in unmixed neat *Fossa alterna* humus, but grow better in a 50/50 mix of the humus and garden/leaf compost. The addition of the leaf compost makes the final mix more crumbly and well drained. The soil should be rich in phosphorus to start to help the plants grow sturdy roots and early shoots. When growing in containers most hungry feeders (like tomato, onion and other vegetables) will require additional feeding and in organic farming this is often supplied in liquid form. Diluted urine can be useful, if applied with care with the addition of wood ash (to enhance potassium) and also liquid feed from composting leaves. However diluted urine should not be applied until the flowers have formed and the early small fruit is starting to grow. If too much nitrogen is given (such as with too much urine application), the leaves will grow abundantly with less fruit production. After fruiting has begun more nitrogen (from urine) and particularly potassium (from wood ash) can be applied for the best yields. Tomatoes do require a lot of attention and special treatment to do their best. For more information on growing tomatoes using recycled human excreta, look at the chapter on gardening techniques.



Growing tomatoes in bags and buckets



## More examples of plants grown with the help of urine



Young mulberry cuttings once established respond well to a dose of 5:1 water and urine weekly (0.5 litres per plant). The same applies to the mint plant on the right growing in a 10 litre bucket.



Passion fruit also responds very well to the application of urine and water. In a 30 litre pot this passion fruit is fed with 1 litre of a 5:1 mix of water and urine weekly. The petrea tree is also fed a 5:1 mix of urine and water (10 litres every month).



Celery also responds well to a 5:1 mix of urine and water (0.5 litres per container weekly). This large radish was fed in the same way.



## MAIZE

Urine can have a significant effect on maize growth. In the fields urine can be applied neat to soil before planting in beds. It can also be applied neat in hollows made near the growing plant. Neat urine applied to maize fields at the rate of 100mls per plant per week and then diluted with rain water, led to increases of cob weight between 28 and 39% compared to watered fed plants only in trials on the Marlborough vlel in Harare (See bibliography Ecological Sanitation in Zimbabwe vol. IV)



Maize trials on the fields using urine.

### Growing maize in containers

Maize is rarely if ever grown in containers, but the effect of the growth of maize in containers when fed urine is stunning. Maize plants are hungry feeders and like a lot of nitrogen. The application of a 3:1 mix of water and urine, once or twice or even three times a week on maize grown in 10 litre containers is particularly effective. For small scale maize or sweet corn production, this method may have application. It is also an effective way of demonstrating the effect of converting the nutrients held in urine into vegetative growth of valuable plants.



Left: The maize plant on the right is being fed with a 3:1 mix of water and urine (0.5 litres) three times per week. The maize on the left is irrigated with water only. The difference is striking. Right: Urine treatment also improves maize cob yield significantly. The total yield of cobs from maize planted in three 10 litre basins is shown. On the left the maize was fed 1750mls urine per plant over the 3.5 month growing period, resulting in a crop of 954 gms. A reduced crop resulted from reduced input of urine (middle). Maize plants on the right were irrigated with water. This is a very high rate of urine application, but one happily accepted by the maize plants in the containers which were irrigated frequently with water to keep the maize plants healthy.

## A experiment with maize grown in containers



24 ten litre cement basins filled with relatively poor topsoil were planted with maize seedlings on 30<sup>th</sup> October 2002 and watered for a week. The application of varying concentrations of a water/urine mix then began.



Photos taken on 3<sup>rd</sup> December 2002 after about 5 weeks of water/urine application. The dramatic differences in growth rate of plants is easy to see – water treatment only on extreme left and maximum urine treatment on extreme right with intermediate applications between. Vigorous growth of maize can be seen with the highest urine application on the right. The maize was harvested on 30<sup>th</sup> January 2003.

### Part of the maize harvest



Part of the total harvest showing the effect of urine treatment on maize growth in basins. The maize plants held in basins which were fed only water produced a pathetic yield as what nutrients were available were quickly used up by the maize. However where diluted urine was applied, the growth of maize was considerably enhanced in proportion to the amount of urine added.



## The complete maize harvest

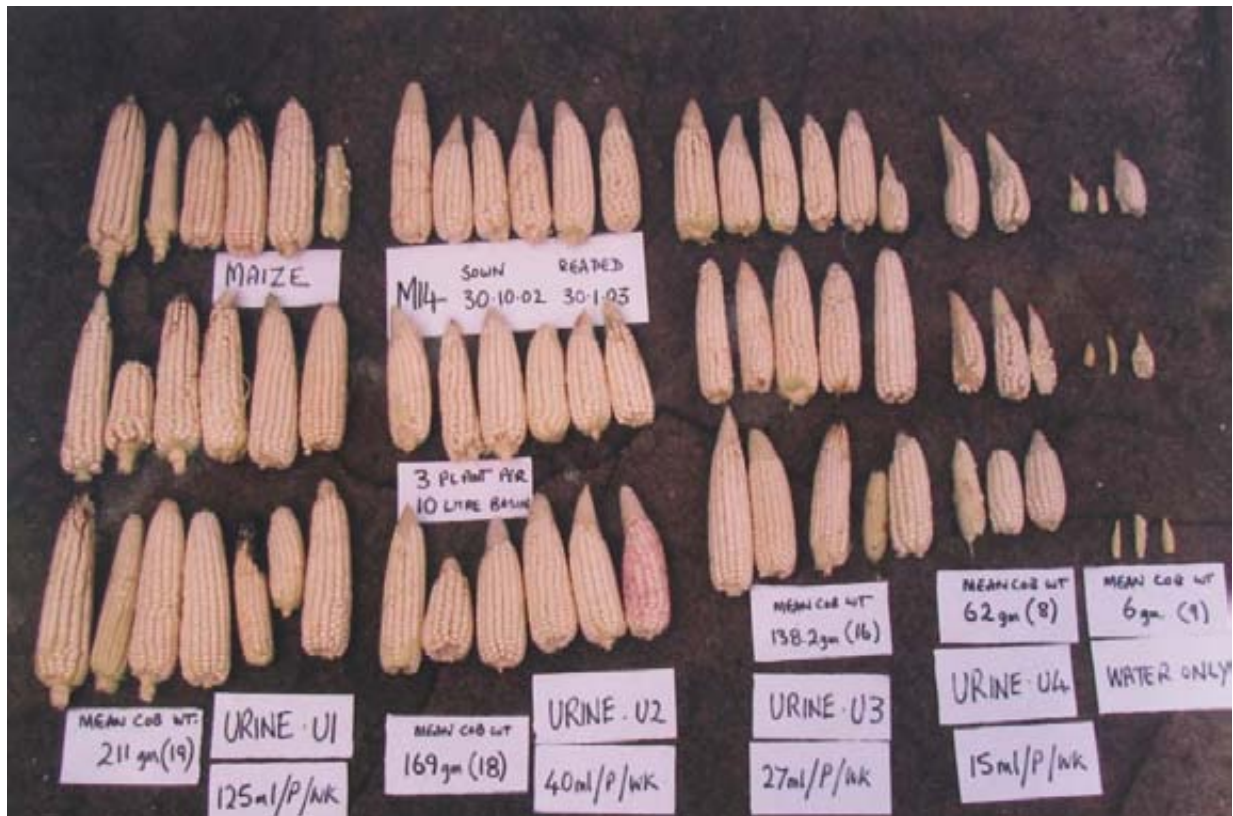

A single photo shows the effect of different amounts of urine applied to maize plants over a 3 month period. On the left (U1) the plants have been fed a 3:1 water/urine mix three times per week (125 mls per plant per week). This has led to a mean cob weight of 211 gms. The 3:1 mix was applied to the U2 group once a week (40 mls per plant per week) and has led to a mean cob weight of 169 gms. A 5:1 mix was applied to the U3 group once a week (27 mls per plant per week) and has led to a mean cob weight of 138.2 gms. A 10:1 mix was applied to the U4 group once a week (15 mls per plant per week) and has led to a mean cob weight of 62 gms. Those plants fed water only produced a mean cob weight of only 6 gms. 99.4% of the total cob mass shown in this photo is derived from the nutrients provided by the urine.



Maize – Africa's most important crop

## 11. Urine diversion – how to build and manage a single vault composting toilet system.

### Urine diversion

In a third range of latrine designs, the concept of **urine diversion** is used. This is a well established method which is being used successfully in many parts of the world. Countries in Europe like Sweden, use it a great deal in the new era of ecological sanitation which is taking off in the northern hemisphere. It is being strongly promoted by the Swedish EcoSanRes group and also GTZ. The concept of **urine diversion** is also being used widely and successfully in Mexico, Central and South America (El Salvador, Guatemala, Ecuador), India, Japan and also in China, where the recycling of human wastes has been practised for generations. It is also being promoted on a relatively large scale in South Africa (Austin and Dunker, 2002) and Uganda by the Ministry of Water, Lands and Environment (MoWLE, 2003). The use of this method is well documented. A book entitled *Ecological Sanitation* (1998) by Esrey et.al. is particularly valuable and the second updated edition will be available in 2004. For a list of suitable references see the bibliography at the end of this book.

Urine diverting toilets use a special pedestal in which the urine enters the front part of the pedestal and is then diverted through a pipe and is thus separated from the faeces. In China and a few other countries where the squatting position is favoured, urine diverting squat plates are used. These are very successful. The urine can either be collected in plastic or concrete containers of some sort, or it can be led into a soakaway system. Considering the value of the urine, to allow it to soak away, unless on to a mature tree like a banana, is somewhat wasteful of a valuable resource. The faeces fall down directly into a brick lined vault beneath the pedestal. Some dry soil and wood ash (or lime in some countries) is added to cover the faeces after every visit. This covers the deposit and helps to dry out the surface of the faeces and makes them easier to handle and transfer. The distinct advantage of this method is that the urine can be collected separately, making it available as a liquid fertiliser. Also the solid component, being in a semi dry state, is much easier to handle and is safer from the beginning, even if it does initially contain pathogens. Being semi dry, it does not smell so much and its potential as a fly breeding medium is much reduced compared to the mix of urine and faeces. Eventually the faeces become completely desiccated.

Semi dryness is essential for the success of the urine diverting system. There must be no malfunction of the urine diverting pedestal. In other words, urine must always go down the front and faeces down the back. If there is an error made in this use, the system can malfunction badly. Blocked pipes carrying urine need unblocking. It is possible that soil thrown down the pedestal may enter the urine pipe, and sometimes even faeces if used by children. Thus the pipes used must be wider rather than narrower, and easily washed out. Also if urine (or water) finds its way into the above ground “dry” vault, the result can be messy and unpleasant. Meticulous use is rather an essential component of the urine diverting concept. This is one reason why alternatives are also recommended in Southern and Eastern Africa, as they are simpler and cheaper, being more forgiving of misuse. The writer has used an above-the-ground single vault urine diverting toilet for several years in his garden and this experience is reported in this chapter. Both home made and commercially made urine diverting pedestals have been used. Initially urine was taken to a seepage area, but this was modified so that urine was collected in a 20 litre plastic container for use in the garden. This system has proved to be an excellent asset to the homestead and has given far fewer problems than the conventional water born system used in the house.

## The “*Skyloo*”

The *Skyloo* is the name given by the writer to this particular version of a urine diverting toilet. It differs in several ways to the standard urine diverting method of building and processing the excreta. In the “*Skyloo*” faeces are collected in a single small vault built above the ground. Whilst faeces can accumulate directly in the single vault for periodic removal, the preferred method in this case, has been to contain them in a 20 litre plastic bucket (together with toilet paper, soil and wood ash). The bucket contents are held within the vault only for a relatively short period, until the bucket is nearly full. Then they are transferred to a “secondary composting site” for further processing. These sites may be in the form of cement jars or buckets or shallow pits or trenches and even garden compost heaps. In each case the formation of humus is encouraged by combining the various ingredients in the bucket with more soil and also some water to add moisture to the mix. Some leaves can also be added. The mixture of ingredients is converted into a pleasant smelling humus-like soil within a few months. This humus can be used to grow a variety of trees, vegetables and flowers. Nothing has gone to waste. Once again the recycling of human excreta is made as simple and convenient as possible. Natural processes are involved.

The humus resulting from composted human faeces makes an excellent soil conditioner and is rich in nutrients as the soil analyses revealed later shows. The important lesson that comes out of this experience is that human faeces, once composted into humus, have a considerable value of their own, not only in providing extra nutrients, but also by improving the texture of soil. The resulting humus can be used directly for growing trees, vegetables and flowers or it can be mixed with less fertile soils to improve the overall quality of the soil. The use of garden and leaf compost generated in the garden is also important so that a combination of these various plant growing media can be encouraged. Thus those practising ecological sanitation should also be familiar with the methods of making garden and leaf compost so that all these fertile materials can be mixed to form a good planting material. The human fraction enters the system and becomes part of it. Such humus when properly used in agriculture helps to improve food yields and also food quality and hence provides more food security and improves the nutritional status of the beneficiaries.

### **The *Skyloo* - a general description.**

The *Skyloo* is built upon a base made of concrete cast on the ground. Above this concrete base is built a shallow “vault” made of bricks and cement mortar. The vault only needs to be a little deeper than the bucket which will be fitted inside it - that is less than 40cm deep. A concrete slab is laid on top of the vault with openings for a vent pipe and urine diverting pedestal. An additional slab is made to fit on the rear of the vault for easy access into the vault and removal of the bucket. A urine diverting pedestal is fitted over the hole in the concrete slab. The urine pipe from the pedestal can direct the urine into a soakaway or preferably through the wall of the vault into another brick built chamber which contains a 20 litre plastic container to receive the urine. Next, a suitable superstructure is built or mounted on top of the latrine slab. This can be made of wood, bricks, plastic sheets attached to a frame or in any way that affords privacy. All hardware in direct contact with urine should be made of durable plastic – not metal - urine is very corrosive.



# How the urine diverting toilet works

## SIDE VIEW

The urine diverting pedestal directs urine into a pipe which is led to a urine storage container

The faeces drop directly down into the bucket held within the vault

Dry soil and wood ash are added to the bucket after every visit

When the bucket is nearly full the contents are deposited in a composting site away from the toilet.

The empty bucket is returned to the vault.

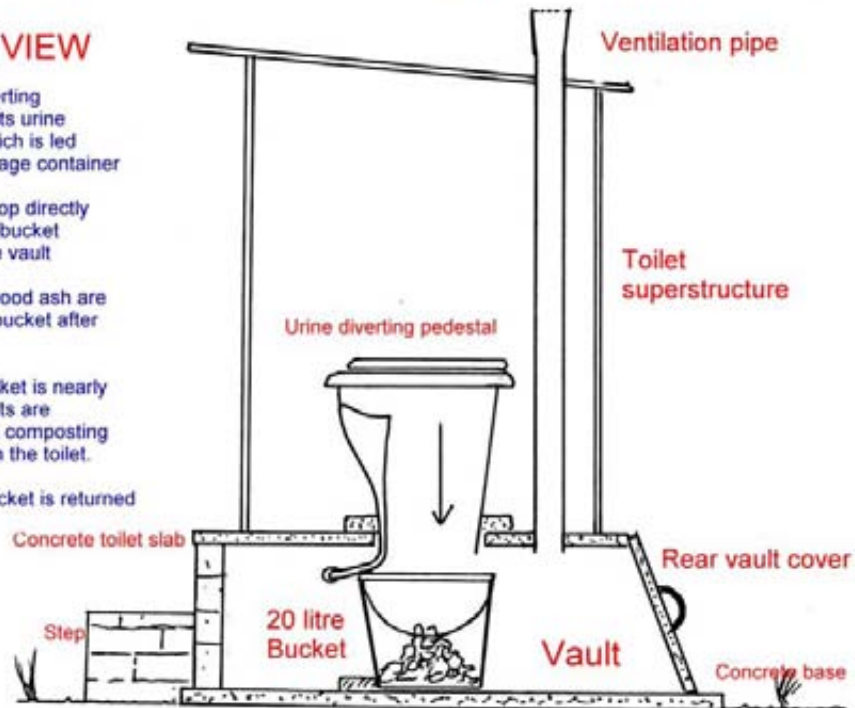

## FRONT VIEW

Bucket contents taken to "secondary composting site" such as a trench pit or cement jar

Urine pipe to funnel and urine tank inside side chamber

Faeces, soil and wood ash added to bucket in vault

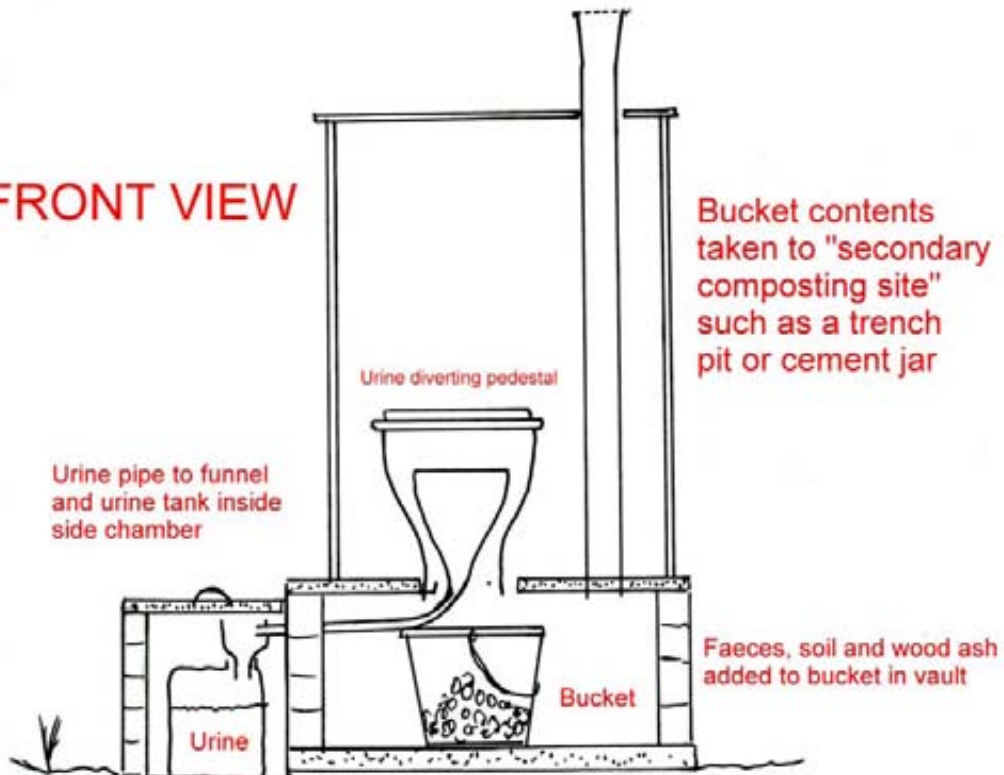

## The “SKYLOO” - Stages of construction

### Stage 1. Making the base slab

This is a concrete slab laid on level ground which will form the base of the *Skyloo*. This forms the foundation for the whole toilet. A concrete mix is made using five parts clean river sand and one part cement (or 3 parts river sand, 2 parts small stones and 1 part cement). The concrete is cast within a mould made of bricks, the dimensions being 1.35m long X 0.9m wide X 75mm deep. An area for the step is also made 450mm long and 335mm deep. Some steel reinforcing wires are placed in the concrete. It is left to cure for at least 2 days before any brickwork is built on top of it. It should be kept wet for several days to cure properly



On the left the brick mould for the *Skyloo* base slab. This is cast on level ground at the toilet site. The whole structure is built on top of this. On the right the mould for the toilet slab. This is cast with the same mix of ingredients as the base slab and is 1.2m long and 0.9m wide and about 40mm deep. Holes are cast in the slab for both the pedestal and the vent pipe. The exact method of making the concrete slab is described in the toilet construction chapter. In fact the same basic slab can be used to make an *Arborloo*, a *Fossa alterna* or this urine diverting “*Skyloo*.” Using the same slab it is therefore possible to upgrade the system over time. Money spent on making concrete slabs and other concrete structures is well worth while since they usually last for a lifetime and are a good investment in both money and time.

### Stage 2. Making the latrine slab

This is made with a mixture of 5 parts of quality river sand and 1 part of cement or three parts river sand, two parts small stones and one part cement. It is reinforced with 3 or 4mm steel wire - 4 lengths in each direction. The slab is made 1.2 metres long and 0.9 metres wide and about 40mm deep. Holes are made for the vent pipe and the pedestal. The pedestal hole is made about 30-35cm from the rear end of the slab and the vent pipe hole (110mm in diameter) is made about 15cm in front the rear and side of the slab. The hole for the pedestal is made using a plastic basin or 20 litre bucket and this is laid in the final position. The hole size must match the pedestal being used. The vent hole is made using a short 75mm length of the pipe which will be used for the vent. This may be a PVC vent 110mm diameter. The slab is cast on flat ground on a plastic sheet. Bricks can be used as a mould, or timber. Half the mix is made first, then the wire reinforcing is added, followed by the remaining cement. The concrete work is made flat with a wooden float, then finished off with a steel float. About 10 litres of cement (quarter 50 kg bag) mixed with 50 litres good river sand (or 30 litres of river sand and 20 litres small stones) is a good mix. The slab is best cast in the late afternoon, left to harden overnight, then watered and covered with plastic sheet. It is kept wet for at least one week before moving. Whilst the slab is curing, the rest of the *Skyloo* structure can be built. Such a slab, well made will last indefinitely.

### Stage 3. Making the vault, step and lintel

The vault is built up in fired bricks and mortar to the required height on the base slab. If a 20 litre bucket is used the vault should be about 40cm high. This will require about 4 courses of bricks built on edge or about 6 courses built normally. The walls are built so that the outer measurements of the top are 1.2m X 0.9m and the base 1.35m X 0.9m. This allows for the slope at the back of the vault over which the vault access slab at the rear will be fitted.



Stages in making the vault. The brickwork

Since the rear end of the latrine slab will not be supported on a brick wall it is desirable to make a reinforced concrete lintel which spans the rear end of the vault. This is made with 3 parts river sand and one part cement and reinforced with 3 or 4mm wire. It should be 0.9m long and be 225mm X 75mm wide. Once cured after 7 days it can be carefully mounted on the rear wall of the vault as shown in the photo above.

### Stage 4. Making and fitting the vault access slab

This is made in thin high strength concrete using 2 parts river sand and one part cement with 15mm chicken wire as reinforcing and two wire handles inserted for lifting. The dimensions are about 90cm X 45cm high (the exact dimensions must match the vault). This is cured for a week and will be rested against the sloping rear side of the vault. A neat, almost airtight fit is required. This is made by applying strong cement plaster to the vault brickwork and grease to the adjacent cement panel side and bringing the two together. After curing the panel can be withdrawn leaving an exact impression on the vault. This is shown in the photo below. The concrete slab is then fitted and bonded on top of the vault in cement mortar.



The vault access slab and the toilet slab have now been fitted. The superstructure must now be made.



## Stage 5. The urine diverting pedestal

Urine diverting pedestals can be home made (see chapter 13 for various methods of home made urine diverting pedestal and squat plate construction), purchased commercially or modified from commercial non urine diverting pedestals which are more commonly available. The “*Skyloo*” described in this chapter used a home made urine diverting pedestal at first. Later this was replaced by a urine diverting pedestal made from a commercially available non urine diverting pedestal. This was modified by adding a urine diverting wall and a urine outlet pipe.

Home made urine diverting pedestals can be made from off-the-shelf plastic buckets and cement. The photos below show one possibility. The plastic bucket forms the inner shell of the pedestal and it is surrounded with cement mortar. Another plastic bucket is cut and trimmed to fit inside the first. The urine is channelled down and led off through a pipe to a soakaway or preferably into a urine storage container.



Stages in making one “home made version” of a urine diverting pedestal. Urine in this case ran down through the hole into another plastic bucket held within the vault and then to a soakaway.



On the left the home made urine diversion unit is fitted over the slab. On the right the improved urine diverting pedestal, fitted with wooden seat. Note also the vent pipe fitted behind the pedestal to the right.

### **Stage 6. Mounting the pedestal.**

Pedestals are mounted over the hole in the slab and cement mortared in position. It is important that this joint is watertight, so that any water falling on the slab (from rain or washing water) does not drip into the bucket below which must contain faeces, paper, soil and wood ash only – absolutely no water.

### **Stage 7. Adding a urine collector.**

Urine is a valuable plant food and is best collected in a container. The best method is to build an extra brick side-chamber on one side of the vault. This will house a plastic container of about 20 litres capacity which will receive and store the urine. A plastic pipe is led from the urine outlet of the pedestal through the side wall of the vault into the brick side chamber so that the urine can be caught by a small funnel which directs it into the urine storage container. The brickwork of the side chamber is built up to enclose and protect the container and the piping. The chamber is covered with a concrete lid with handles. It is important to ensure that the plastic pipe leading from the urine outlet to the container falls continuously and does not pass through a loop which will act as a water trap or air lock. The side wall chamber must be big enough to house the container so that it can easily be withdrawn. Since urine is very corrosive, the piping and container must be made of stout plastic. Metal parts will corrode.



**A plastic pipe is led down from the urine diverting pedestal through the side wall of the vault into a plastic container held within a small brick built side vault. A home made funnel is used to guide the urine into the container. The side vault is built up on soil so that any urine overflow can drain away.**

### **Stage 8. Making the superstructure**

Many types of superstructure are possible for urine diverting toilets. They are built in one location and thus can be made from bricks or timber, metal sheeting, asbestos sheeting, reeds, grass or of any material that offers privacy. In this case, the vent pipe is placed within the structure and the roof must have a hole made for the ventilation pipe to pass through. Structures are fitted with a door of some sort. A roof is essential as this prevents rain water entering the interior and the pedestal. Water must not be allowed to penetrate into the vault.



## *Skyloo* superstructure



The superstructure in this case has been made from a frame of polyethylene pipe covered with plastic "shade cloth." This is not very robust, but has proved very adequate over a four year period. The urine diverting pedestal is smart and comfortable. A mixture of soil and wood ash (4:1) is stored in one container, with dispenser. Toilet paper is held in another container.



Finished structure with side vault for urine collection. The rear vault access door is neatly fitted. A 20 litre bucket has been fitted within the vault. Two bricks cement mortared to the floor locate its best position directly beneath the pedestal chute.

### **Stage 10. Finishing off**

Make sure the rear access door fits well at the rear of the vault. The vent pipe will function better if the vault is well sealed. Two bricks can be mortared on the base slab to locate the best position for the bucket which is directly under the pedestal. The vent pipe is fitted into the toilet slab and through the roof. A latch is fitted to the door to hold it closed. A mix of dry soil and dry wood ash (4:1) is provided in a container. It is best to mix bulk dry soil and ash first and hold in a sack, or dust bin, then bring to the toilet in small lots.



## Use and management of the *Skyloo*

Since the faeces from the *Skyloo* will be used to make humus, it is essential that soil and wood ash are added after every visit to the latrine. The bucket then fills up with a mixture of materials which compost easily - faeces, paper, soil and wood ash. It is wise to pre-mix the soil and the ash first (mix of four parts soil to one of ash), when these materials are in the dry state. This can be stored for use in a larger container or sack and brought and stored in smaller containers within the toilet. The ash and soil can be applied down the chute using a small cup or home made dispenser – the one used on the *Skyloo* is made from the upper part of a plastic milk bottle. Half a cupful of the mix is added after every deposit made. When the bucket of contents is nearly full, its contents are transferred to a “secondary composting site” for further processing. The rate of filling obviously depends on the number of users and the amount of soil/ash added. Weekly transferral may be required for a family of about 6. For a single user, the bucket may take 4 – 6 weeks to fill up. The urine accumulates in the plastic container until it is nearly full. This urine can be used in various ways (see Chapter 10).

### Processing the faeces

The faeces (without urine) fall directly into the bucket, and it is wise to put some humus or leaves in the base when it is empty to avoid sticking and to help start the composting process off. In this unit the bucket is removed and its contents transferred to a “secondary processing site” quite regularly. The frequency of moving the bucket and its contents depends on how quickly the bucket fills up and this is related to the number of users. In the *Skyloo* fresh excreta does not remain in the toilet system itself for long. It may be just a few days or a week or two at most. However, at the ambient temperatures found in Harare (the temperature of faeces held in buckets hovers around 18 degrees C.), the combination of faeces, paper, soil and wood ash does start to degrade. Thus in practice the toilet can be considered the “primary processing site” (in so far that the ingredients are placed together and start to change their form) - but the period is brief. When the bucket is nearly full, the rear vault access slab is removed and the bucket withdrawn and its contents tipped into a “secondary composting site” nearby. Some soil is placed back into the empty bucket and then it is placed back in the vault beneath the pedestal. The rear vault slab is replaced and the toilet can be used again. This transferral of materials from primary to secondary composting sites is quick and easy.



The bucket is withdrawn from the vault and its contents tipped into a shallow pit composter or a split cement jar as shown above. The 30 litre split cement jar is ideal for processing human faeces. Fertile soil is added on top of the excreta and a strong lid placed over the top for protection. More deposits are made when the bucket fills again. After 3 or 4 months the contents are pleasant to handle. Naturally it is always wise to wash hands after handling humus of any type – including this variety. The conversion is a *Miracle of Nature*.

## Secondary composting sites.

Several “secondary processing sites” have been tested over the last three years with the *Skyloo*. These are sites where the raw excreta is converted into a product which is best called humus. The humus has the appearance of loam like soil and smells pleasant. These sites include shallow pits (tree pit or fertility pit or twin shallow pits), trenches, compost heaps and also buckets or split cement jars where the composting process can take place. Plastic bags have also been used. The tree pit is a shallow pit covered with a lid into which the bucket contents are placed and then covered up with fertile soil. When the pit is almost full it is topped up with a good layer of topsoil and a young tree is planted in the topsoil. This works like the *Arborloo* – in fact this method preceded the *Arborloo* which evolved from it. A similar method is used with a trench, which is filled up in stages with buckets of the mixed composting ingredients.

### What system to use as a secondary composting site?

This will depend on the number of users. If the number of users is small, a series of small jars described later is ideal. If the family is medium to large say between 5 – 10 persons or more it is best to build a twin pit composter where the contents of the bucket are added to one shallow pit until it is nearly full, then to a second shallow pit which fills whilst the contents of the first pit are composting. A composting time of at least 6 months should be allowed.

A single user will completely fill a 20 litre bucket with a mix of faeces, paper, soil and ash in about 4 - 6 weeks. Thus a family of about 6 persons will fill a 20 litre bucket in approximately one week. This means that the bucket must be removed and its contents placed in a “secondary composter” every week. The actual rate of filling will be quickly established. In this case the best composter is the double shallow pit type. This can be built near the toilet.

Amongst these various techniques the writer has predominantly used the method of processing the faeces in split cement jars. This is a very effective and adaptable method and has the advantage that the forming humus can be exposed by dividing the split jar – taking off one of the two jar shells. Over the years this has been one of the best demonstration tools for promoting recycling and ecological sanitation - visitors can see the humus – it is very convincing.



Tipping the contents of the bucket from a *Skyloo* into a small shallow pit for processing. The shallow pit is covered with a concrete lid with hole which is itself covered. On the left three cement jars are shown. The one actively being filled is covered with an attractive painted concrete cover.



## Stages of building a twin pit composter for single vault urine diverting toilet



Stage 1. Choose a level site near the toilet and cast two ring beams from concrete on the ground. The internal measurement is variable but in the case shown here the internal measurement was 0.8m X 0.8m. The width of the ring beam was 15cm and the depth 7.5 cm. A mix of 5 parts river sand and 1 part cement was used. The two ring beams were placed about 0.75m apart. The concrete was allowed to cure for a period of 3 days under plastic sheet. In the photo on the right the bricks and timber shuttering have been removed from the ring beam and each filled with water to loosen the soil beneath.



After a day and night soaking the soil is easier to dig. The photo on the right shows the two pits dug down to about 0.5m metres. The removed from the twin pits has been laid around the ring beams and rammed in place. This makes the pits more stable. The pit which will not be used first can be filled with leaves to compost, whilst the other pit will be filled with a mix of faeces, paper, soil and ash from the toilet. The area around the ring beams is smoothed down and made neat.



A wooden lid is made for the twin pit composter and placed over the pit which is being filled with excreta, soil, paper and ash. The almost full bucket is removed from the toilet vault and tipped into the shallow pit. The deposit is covered with more soil.





On the left a motivated pensioner tips his bucket of contents into the shallow pit. The photo on the right shows the first deposit made into the pit. Many more will be added until the pit is almost full. Since the excreta is close to the soil and is surrounded by soil and the additions are made in "small lots," the composting process is quite efficient. The pits are called secondary composting sites because the actual composting process starts off in the bucket itself and the process continues in the shallow pits.

Leaves can also be added to the shallow pit. These add more air into the system and also further organisms which help to break down the excreta. The final humus is more crumbly in texture if leaves have been added.



Photo showing first addition (left pile) and second addition a month later (right pile) in the composter.

The conversion to humus is already well advanced in the first pile. Note how the toilet paper has disintegrated. The new additions to the shallow pit are covered with a layer of soil and the wooden lid is laid over the pit for protection and safety. Water is added periodically to keep the composting ingredients damp. The two pits are used alternately. Once the first pit has filled up which should take rather more than 6 months, the second pit is used. When the second pit is full, the first pit can be emptied. And the process started again on the original pit.

### **Routine maintenance of the *Skyloo*.**

Routine cleaning and maintenance of the *Skyloo* is important for the best functioning of the unit. This is not an arduous task and can be carried out quickly once every month or two. Urine diverting pedestals have no means of flushing down the sidewalls and it is inevitable that some fouling will take place. Whilst the vent will carry any odours down into the vault and up the pipe, periodic cleansing of the chute is desirable. During normal use, the dry soil/ash mix will cover any side wall fouling, dry it out, and make it less objectionable.

The great advantage of the *Skyloo* system described here, where the faeces are contained in a removable bucket and not a static vault, is that the system can be washed down completely once the bucket and the urine container have been removed. It is desirable that the vent pipe, pedestal and urinal pipe are washed down and cleaned from time to time. First the bucket and urine container are removed and put to one side. The vent pipe (which will normally be made

of PVC) is also pulled out. Cobwebs which may have developed in the vault can then be cleaned out with a small tree branch. The whole unit can then be thoroughly washed down and cleaned out. The pedestal is cleaned entirely from top to bottom including the side walls. The urine pipe is also flushed out with water. The toilets floors and vault can also be washed down with water.

The ventilation pipe must also be washed down and cleaned out from time to time to retain its efficiency. This is because spiders weave their webs inside the pipe and this seriously disrupts the air flow inside the pipe. Efficient ventilation is important and helps to reduce odours and also maintains a constant flow of air through the vault which reduces moisture.

The toilet and its parts are then allowed to dry out and are all put back together (put back bucket, urine container and vent). The dry soil/ash container inside the toilet is constantly being recharged from a larger stored stock elsewhere.

During the wet season, it has been found that Culicine mosquitoes (which do not carry malaria) can hide in the vault and emerge up the pedestal chute during use. Attempts at controlling these mosquitoes have been made by introducing springs of the wild basil *Ocimum canum*, which is know to be a mosquito repellent. No flies have ever been seen.



**The interior of the Skyloo can be completely washed down once the urine container and the bucket containing the faeces, soil and ash have been removed. In the middle the wild basil, *Ocimum canum*, can be used to chase mosquitoes away. On the right a spider – fortunately they rarely travel up the pedestal!**



**Flies have never been seen in the *Skyloo* system, but spiders and mosquitoes do invade during the wet season. Spiders do no harm but can block vent pipes. Mosquitoes in this case are the culix type and not malaria carrying. They look for dark places to hide – they do not breed there – there is no water.**

## **A study of humus formation in jars, soil analysis and re-use of the humus**

The formation of humus derived from human excreta using soil, wood ash and leaves in shallow pits has been described in some detail in the *Fossa alterna* chapter. In the *Fossa alterna* the urine and faeces together are combined with soil and ash etc to form the humus. In the case of urine diversion methods, e.g. *Skyloo*, the urine is separated off and the deposits of faeces are combined with dry soil, wood ash and the paper (used for anal cleansing) and dropped into the bucket held in the vault. This “bucket of contents” is then transferred to another “secondary composting site” like a shallow pit or trench or, as in the case described below, a 30 litre split cement jar.

### **Use of split cement jars as a “secondary composting site”**

When nearly full, the bucket of contents (faeces, toilet paper, dry soil and wood ash) are tipped into the jar, levelled off with a trowel and covered with a layer of good fertile soil. The soil is full of life forms which digest and convert the excreta into humus. Two or three bucket loads may enter the jar before it is nearly full. After the last filling the excreta is levelled off again and topped up with about 5 cm layer of soil. This jar of contents should be watered, then covered with a lid and left to decompose. The various ingredients will decompose within three or four months to form humus which can then be removed and used much in the same way as the eco-humus taken from the *Fossa alterna*. Tomato growing is the best option. The empty jar can then be reused time and time again.

When made properly, the cement jar can be used time and time again - being made of concrete. It is also cheap. The jar has a wider base than top so the contents held within it are well drained. That is important if a good conversion from excreta to humus is to be effected. During the period when the faeces are converted into humus, which may be as little as three or four months with this method, there is no (or very little) temperature rise within the jar. The conversion is rapid because the conditions seem to be ideal. There is a relatively high ratio of soil to excreta, and the conversion is made “in small lots” where no pocket of excreta is large and all excreta is relatively close to some living soil. As the mass is converted, it also contracts as the water content of the original excreta (which may be as high as 70%) is absorbed into the soil within the jar or drains away under the jar. In practice the level of the plug of soil held within the jar drops as its volume decreases. Also the diameter of the “plug” is reduced and this can leave a gap or small air space between the soil and the jar, which obviously retains its original dimensions. The soil near this air space is very active biologically. Thus the core of converting matter is moist, well drained, well aerated and close to the living soil - all ideal conditions for an effective conversion of faeces into humus.

### **Biological activity within the jar**

The contents of the jar are biologically very active during the conversion stage and thereafter. The process is aided by adding a layer of fertile topsoil to the container and planting young plants of various types into this upper layer. The conversion process whereby faeces are converted into humus is the result of the activity of bacteria and fungi present in the added soil which thrive under ambient temperatures (that is temperatures which are close to the surroundings). Many other beneficial organisms, including worms, insects and many other life forms also thrive at their best at ambient temperatures. These animalcules and microbes appear to digest the excreta and may also considerably reduce the number of pathogenic



organisms, such as bacteria which carry disease. In tests carried out on jar humus, pathogenic bacteria such *Escherichia coli*, *Salmonella sp*, *Shigella sp*, and *Staphylococcus sp*. were absent after only 3 months of composting (From tests carried out by Clinical Laboratories, Harare - Frank Fleming. pers.comm.). This aspect is further discussed in the chapter on Health. Care is obviously required when handling any compost of this type.

The process is an entirely natural one leading to the formation of humus. The process may best be described as “*Ambient Temperature Composting*” since it takes place at a temperature close to the natural surroundings. The soil added should ideally be fertile and contain living organisms for the process to take place at its best. These fertile soils and leaf moulds also absorb much of the moisture content of the excreta, and the process is normally associated with a reduction of volume of the mass. Remarkably however the process still takes place where poor soils are added to the excreta, albeit less efficiently, and the final product may lack the texture of the best humus – but it certainly is high in nutrients, which come from the faeces.

In addition, the roots of the plants invade the body of the container as the plants grow and this provides an extensive biological structure within the decomposing materials which assists the process of converting the faeces into a friable and acceptable humus like soil. The extent of the root invasion depends on the plant type. Not all plants will send their roots down the entire depth of the jar. Certain types of flower are very effective at invading the contents of the jar (or bucket) and penetrate the entire space occupied by decomposing matter. The giant “*crackerjack*” marigold is a good example. Within 3 months its roots invade the entire contents of the jar or bucket and provide an extensive biological surface which assists in converting the faeces into soil. Obviously in doing this the flower is taking nutrients away from the humus.

The absorbing root-soil interface is called the rhizosphere. It is within this thin microscopic layer that surrounds the roots and root hairs that much biological activity takes place. There are many living organisms present in soil and around the rhizosphere - bacteria, fungi, protozoa, slime moulds, algae, soil viruses which together with nematodes, earthworms, millipedes, centipedes, mites, snails and other small animals, compete for water, food and space. The roots provide a multitude of surfaces for microbial colonisation. The roots also provide oxygen, essential for effective biological processes and also other nutrients that the micro-organisms require. These include carbohydrates, organic acids and many other substances essential to the life within the rhizosphere. The abundance of life in this active biological zone form micro-cavities where the micro-organisms live. In nature, decomposing vegetable matter within the soil helps to make conditions optimal for these organisms. The plant itself takes up water, nitrates, phosphates, potassium, sulphates, and many trace elements. Thus as the roots of plants invade the decomposing materials in the bucket, they greatly assist in the natural processes which lead to the conversion of faecal material into humus simply by generating enhanced biological activity throughout the root zone.

## Diagram of cement jar and contents

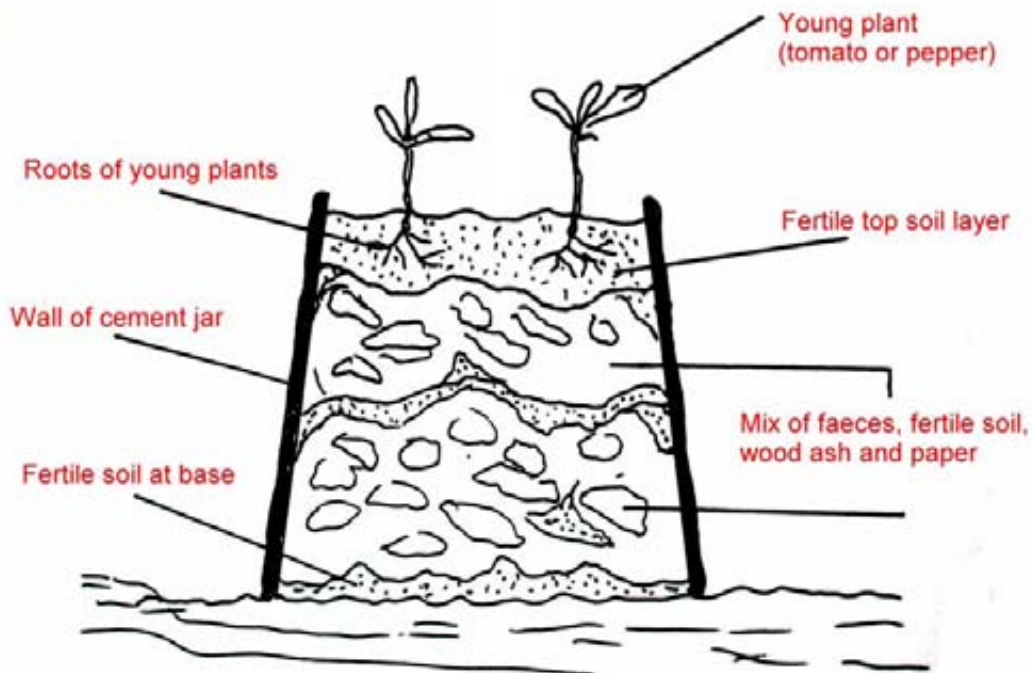

The final texture of the humus formed very much depends on the type of soil added. If the soil is a lifeless sandy soil, the final texture of the humus will be more sandy. If the soil added is fertile and humus-like itself, then the final product will be more crumbly and humus like. Thus the texture of the end product depends on the soil added. It is also possible to add leaves to the mix and this will greatly improve the texture of the humus. In all cases the combination of soil and human faeces considerably enhances the level of nutrients in the final soil produced. The increase in nutrient levels is dramatic and can transform even the most barren soils into soils which are fertile and able to sustain plant growth. The following charts show the levels of major nutrients in the 30 litre “secondary composting jars” combining human faeces, wood ash and soils.



View of composted humus derived from faeces, soil, ash and paper held in jar

## Nutrient levels in 30 litre jar humus - an analysis of soil

Soil analyses reveal that humus formed in cement jars which act as secondary composting sites for the *Skyloo* is rich in nutrients and well above levels found in naturally occurring top soils. Soil is enhanced by the addition of faeces alone as can be seen in the jars used to compost humus faeces following separation in the urine diverting system.

The figures below show the pH and levels of Nitrogen (after incubation), Phosphorus, (ppm) and also Potassium, Calcium and Magnesium (ME/100gms.) in samples of humus excavated from jars used to process faeces derived from the *Skyloo*. These results are compared with soil analyses carried out on various naturally occurring soils in Zimbabwe and also *Fossa alterna* humus.

### Examples of nutrient levels of soil formed 30 litre composting jar (*Skyloo*)

Soil source	pH	N	P	K	Ca	Mg
Jar 1.	7.1	211	351	2.22	30.89	14.11
Jar 2.	6.8	230	272	4.40	46.71	30.3
Jar.3.	6.2	308	274	0.96	34.60	14.22
Jar 4.	6.8	141	204	4.64	32.56	11.79
Jar 5.	6.1	148	347	1.38	29.36	6.90
Jar 6.	7.1	328	350	5.76	15.30	7.25
Jar 7.	6.7	246	194	3.24	63.80	9.68
Jar 8.	7.0	249	387	1.95	4.56	2.29
<b>Mean value (composting jar-Skyloo)</b>	<b>6.72</b>	<b>232</b>	<b>297</b>	<b>3.06</b>	<b>32.22</b>	<b>12.06</b>

### Comparisons

Mean value (local soils)	5.5	38	44	0.49	8.05	3.57
Mean value ( <i>Fossa alterna</i> )	6.75	275	292	4.51	11.89	6.14
Mean value (composting jar-Skyloo)	6.72	232	297	3.06	32.22	12.06

These figures show clearly how human faeces when mixed with soil can produce a product with significantly more nutrients than most naturally occurring soils. Enough nutrients in fact to mix in equal proportions with existing top soils to enhance the final product sufficiently to make viable vegetable production possible without further fertilisation.

Whilst in most cases good fertile topsoil taken from the garden was added to the jars and wood ash had also been added in the toilet itself in combination with dry topsoil to help the composting process, in some cases the soil added was deliberately poor and added without wood ash, to assess the importance of the faeces in providing nutrients to the final product. The following figures show these the dramatic elevation in nutrient levels.



## The effect of human faeces on soil fertility

### Example 1.

Soil source	pH	N	P	K	Ca	Mg
Nutrient level of soil added.	4.0	18	9	0.08	1.46	0.32
Nutrient level of final soil in jar.	6.1	148	347	1.38	29.36	6.90

### Example 2.

Soil source	pH	N	P	K	Ca	Mg
Nutrient level of soil added.	5.5	27	5	0.29	10.23	4.11
Nutrient level of final soil in jar.	7.1	328	350	5.76	15.30	7.25

### Example 3.

Soil source	pH	N	P	K	Ca	Mg
Nutrient level of soil added.	6.2	27	32	0.63	9.68	2.30
Nutrient level of final soil in jar.	6.7	246	194	3.24	63.80	9.68

In each of the three cases cited, the resulting soil was derived from a combination of poor soil and human faeces only. These results reveal the value of nutrients available in human faeces. There are dramatic increases in nitrogen, phosphorus and potassium in the resulting humus compared to the original soil. The writer cannot explain some of the high figures reported for calcium, but they are recorded directly from laboratory analysis. The overall picture however is clear enough.

## Comparing the formation of humus in jars and shallow pits

It is interesting to discuss how the processes which take place within small 30 litre jars compares to the processes which takes place within the shallow pits used with the *Arborloo* and *Fossa alterna*. In the *Arborloo* and *Fossa alterna*, the pit volume is about 600 – 800 litres in a 1 – 1.2 metre deep pit. The most significant difference between humus formation in jars and shallow pits is that in the latter, urine is added in combination with faeces. The urine diverting pedestal is not used in the *Fossa alterna* to simplify the construction and use of the unit and also to reduce cost.

However, this does not appear to make a significant difference to the final product as the following figures for eco-humus show. The soil added to both pits was the same.

Soil Source	Ph	N	P	K	Ca	Mg
Soil added to pit	5.5	27	5	0.29	10.23	4.11
<i>Fossa alterna</i> (urine included)	7.6	355	258	7.14	8.97	6.26
<i>Fossa alterna</i> (urine diverted)	6.9	305	230	6.65	12.00	10.32

There is a slight increase in nitrogen as one would expect from humus enriched with urine. Levels of phosphorus and potassium are about the same. Most of the nutrient available in urine is nitrogen (ratio NPK for urine about 11:1:2).

There are several other differences to be noted between the environment of a jar converting human faeces and that of a shallow pit converting human faeces and urine in combination. These can be listed as follows:

1. **Volumes.** The jars are of 30 litres capacity, the pits about 600 – 800 litres capacity depending on depth. The process of conversion is more efficient, the smaller the volume.
2. **Faeces/urine mixes.** The excreta content of jars is faeces only, that of pits a mix of faeces and urine. Thus the moisture content may be higher in pits.
3. **Excreta volumes.** Small lots of faeces are added to the jars and interspersed with soil whereas excreta may build up in larger volumes in pits without being interspersed with soil.
4. **Soil/excreta ratio.** The ratio of soil to excreta in jars is quite high. The volume of soil may be the same as the faeces or even higher. This will promote rapid conversion. This will rarely be the case for shallow pits. It will depend on the nature of management. Soil content in shallow eco-pits will normally range between 30% and 50% by volume. It will be very variable however. Some users may add little soil, thinking that the pit will fill up more quickly and unnecessarily. Others may be more generous. If no soil is added, the unit will act just like a normal pit latrine and the conversion into humus may take several years. People may only be convinced when they have seen the humus being excavated from pits in which meaningful amounts of soil have been added.
5. **Type of soil added.** There may be little choice of the type of soil added to shallow pits. Ideally fertile soil should be added, as this will hold a wider variety of living organisms, but this may not be available, or if it is, it may not be used. As a rule of thumb, the final product of an excreta/soil combination will take the texture of the soil added - the resulting colour will be darker. If sandy soil is added - the resulting eco-soil will be sandy in texture. The combination of poor sandy soil and excreta will not form into a humus-like crumbly soil. That will only happen if leaves are added as well, or if the soil added is humus-like. However the nutrient levels of the eco-humus will always be significantly higher than the soil thrown down the pit.
6. **Distribution of soil and excreta.** In jars, small lots of excreta and soil are added and there is a good mix of ingredients. In pits, when the soil/ash mix is added, a pile of excreta may build up directly under the squat hole or pedestal and added soil may be diverted to the sides of the pile. This forms a core of excreta with a lower percentage volume of soil present, surrounded by material which may have a higher content of soil. The distribution of soil to excreta in the pit will therefore be uneven. It is best to redistribute the various pit materials with a pole.
7. **Drainage.** The jars are well drained. They are mounted above ground with the base having a larger diameter than the top. By comparison, pit drainage will vary, depending on soil type, pit lining type, volume of fluids added (urine and washing water), partial sealing of the pit base with raw excreta etc. Fully brick lined pits will not drain as well as partially lined pits or pits with “ring beam” or no lining. Seepage properties of the pit will also vary depending on factors such as soil area available for drainage and also soil type. Sandy soils drain better than clay soils. When pits are brick lined, some cement may fall to the base and not be removed. This will also slow down drainage. Raw excreta, if spread over the pit base can also form a type of plug also reducing the drainage of the liquid fraction (urine and water) from the pit. None of these conditions apply to the jar. It is advisable to add humus, leaves or compost to the base of shallow pits to assist in drainage. Humus formation is inefficient if the ingredients are too wet. An important challenge is to absorb the urine into the soil added to the pit as this will retain some nutrients in the soil, which will improve the overall quality and usefulness of the resulting humus.

8. **Aeration.** This is related to the volume and type of soil and other organic ingredients added (such as leaves) and its dispersal within the excreta. Generally shallow pits will be less well aerated than jars. The addition of leaves and other vegetable matter will help break up the pit contents. Good aeration is important to humus formation.

Thus the conditions found within the jars and the method of application of the material components of jars favour a more efficient process than is found in shallow pits. It would be expected therefore that the conversion of excreta into humus would take longer in pits. And this is always the case. However, excreta conversion can be efficient within pits if the conditions are right. These will include good drainage, and regular addition of soil/ash/leaves. The higher the ratio of added ingredients like soil, ash and leaves the better the outcome. The urine must either be absorbed into the added materials (soil, leaves, ash) or should be allowed to drain away. Higher temperatures also favour a more rapid conversion. In Salima, Malawi, humus is formed after about 2 months in a very warm climate and well drained sandy shallow pits (Mbachu Msomphora pers. comm). In fully brick lined pits built in soils which drain poorly, the conversion is much slower. In such pits, if the soils are not regularly added, the conversion may take much more than one year. In such cases much more added soil will be required to absorb the urine. Thus the best conversions take place in pits which are only partly lined.

### **Growing plants directly in the jars**

These jars are an excellent way to start off young trees and other plants. Banana, mulberry, guava, paw paw and eucalyptus do exceptionally well. In each case the young plant seedling is placed in the soil layer above the excreta/soil layer. Water is added regularly to keep the jar contents moist. Flowers like “busy lizzie”, canna, and marigold will also grow well in these jars. If the jar is watered regularly, tomato seedlings will grow spontaneously from the humus. Jar humus is an excellent medium for growing pepper and tomatoes – see later.



**Spontaneous growth of tomato seedlings on left are growing on a 30 litre jar with mixed ingredients, including human faeces. Tomatoes often germinate spontaneously in humus derived from human excreta and from organic kitchen refuse. On the right a “busy lizzie” growing on 30 litre jar, also with human faeces and soil mixed. Most plants enjoy growing on this type of soil.**



## Growing tomatoes in *Skyloo* humus

The most obvious use for the humus formed in jars or other containers where the *Skyloo* humus has been processed is to grow tomatoes. When the *Skyloo* humus is watered, tomato seeds present in the mix germinate freely and form into excellent seedlings and later into healthy plants. It is assumed that the seeds are derived from tomatoes consumed months before by the toilet user. The seeds are passed out in the faeces into the bucket and there lay dormant until the humus is processed and watered. Then the seedlings appear in large numbers. If the seedlings are just allowed to continue growing in the jar, they become overcrowded and do not provide a good crop. So the best procedure is to move the seedlings from the jar and transplant into other containers in preparation for placing in buckets.

Tomatoes grow very well in the *Skyloo* humus, especially when mixed with an equal volume of garden compost or leaf compost. Bumper crops of tomatoes rely on adequate levels of phosphorus at an earlier stage, and then later sufficient quantities of nitrogen and potassium. Potassium is particularly important for the best yields. Potassium can be supplied in the form of wood ash added to the soil or to liquid feeds. The careful application of diluted urine (5:1) can also help, provided wood ash is also applied to improve the balance of nitrogen and potassium. Leaf compost liquor (see later) also helps to increase crop production. An excess of nitrogen gives a lot of leafy growth at the expense of tomato production, so a careful balance of nutrients is required for tomatoes. For more information on the technique of growing tomatoes using recycled human excreta look at the chapter on gardening techniques.



A tomato planted on a bucket of humus collected from the *Skyloo* jar. Once watered the humus produces large numbers of tomato seedlings which can then be transplanted into other containers.



The seedlings can first be transplanted into seed trays and then into small pots or tins.





Here an established tomato seedling is transferred to 10 litre bucket full of neat *Skyloo* humus.



On the left a tomato seedling planted on a 10 litre bucket of neat *Skyloo* humus on 10<sup>th</sup> Jan 2004. On the right the same plant about 5 weeks later on 16<sup>th</sup> February. It was irrigated with water only. The plant is healthy. Lower shoots and the shoots growing in the axils of larger shoots have been removed. Bumper crops of tomato rely on adequate amounts of potassium being available. The addition of wood ash to the soil or in the liquid food or water can increase production. But tomatoes do require a lot of care and management. The tomatoes shown on this page succumbed to a fungus disease called late blight. For more information see the chapter on techniques that assist eco-san supported vegetable gardening.



## Growing tomatoes on mixes of *Sky/oo* humus and composts



The best soil for growing tomatoes under the umbrella of ecosan is a mix of humus from the toilet and leaf or garden compost. A 50/50 mix is ideal. Similar seedlings planted on 10<sup>th</sup> January growing in 50/50 mix of *Sky/oo* humus and garden (80 litre jar) compost after 5 weeks of growth (left photo). Right photo: 5 weeks of growth on tomato seedling grown on a 50/50 mix of *Sky/oo* humus and leaf compost. Photo taken 16<sup>th</sup> February.

## Feeding tomatoes growing on neat *Sky/oo* humus with liquid feed



Similar seedlings planted on 16<sup>th</sup> January growing on (left) neat *Sky/oo* humus fed with a 5:1 mix of water and urine (0.5 litres) once per week and on (right) neat *Sky/oo* humus fed leaf compost liquor, twice a week. See details on leaf compost liquor later. Photo taken 16<sup>th</sup> February, 2004. The plant on the right had 44 flowers at that time, each one with the potential to become a tomato weighing 100 gms.





Healthy tomato grows from 30 litre jar filled with *Skyloo* humus. On the right green pepper grow in jar of composted faeces with soil and ash. The jar humus is perfect for tomatoes and peppers.

### Starting young trees on *Skyloo* humus

Young trees of all sorts grow very well in these split cement jars. Once the contents have been changed to humus and the young tree is well established, the two halves of the jar can be removed and plug of soil bearing the tree can be removed by cutting through the base with a flat spade, thus separating it off from the ground. The tree and the “organic plug” can then be transferred to another site where the tree can continue its growth. The jar is then used again. Alternatively, if the jars are placed in a suitable place, the jar can be removed and re-used and the tree can continue to grow on the original site. This seems to work well.



This young guava tree was grown from seedling stage in the jar. It was planted in the topsoil placed above the faeces/soil/ash/paper layer. In a few months all the faeces have been converted and the young tree can then grow in rich humus. It is later moved to its final growing site. This is like a miniature version of the *Arborloo*. The same method can be used for shrubs and perennial flowers.

The jar method is also very valuable as a teaching aid. The contents can be closely observed at any time by removing one of the jar halves (shells) temporarily. The two halves are held

together with a loop of wire. I have shown many people these jars in my garden and all of them have been most impressed when the jar is opened and the contents are handled and sniffed! It is possible to take out a handful of “soil” from the jar, after 6 or more months of composting. This demonstration is most convincing.

Bacteriological analysis of the soil has revealed it to be free from pathogenic bacteria like *Escherichia coli*, *Salmonella sp*, *Shigella sp*, and *Staphylococcus*, that had been artificially added two months before. This is very remarkable since half the volume of the original contents were raw faeces only a few months before analysis. Nonetheless care is always required when demonstrating and handling converted faeces, whatever they look or smell like. A period of at least 4 months should elapse before the jar humus is handled. It is a good idea to show the hand washing device too and get participants to use it. In the writer’s garden plenty of soil was added and the jars kept moist to encourage composting. The ingredients taking place in this remarkable transformation are human faeces, fertile soil, wood ash and toilet paper. Leaves are also being added and help a lot. The pH is about 7.0 and the temperature of the jar contents less than 20 degrees Centigrade. This conversion, from a harmful and most offensive material into pleasant and valuable humus is nothing short of a miracle of Nature. Every visitor who views the transformation is both surprised and convinced. It is perhaps the most compelling evidence that transformed human excreta can be both relatively safe and valuable too. To sum up, the conversion of faeces into fertile humus is a remarkable process which is entirely natural. It is truly one of Nature’s marvels.



***YES- raw faeces can change into fine humus!***

**BUT CARE IS REQUIRED IN THIS IMPORTANT DEMONSTRATION**

## **12. Gardening techniques that assist eco-san supported vegetable and fruit production**

We have now discussed the methods of building and using eco-toilets and how their produce may be used with beneficial effect in the garden, but some extra techniques will also help. The production of vigorous healthy vegetables requires effort and also knowledge of the soil and the plants themselves. Some vegetables are easier to grow than others. Most basic top soils do not have sufficient nutrients in them to provide healthy vegetable growth. Such soils require extra ingredients added to them in the form of humus, compost, manure or organic liquid food or ideally a combination of these. A good soil texture as well as an adequate level of soil nutrients is also very important. And the other vital component is water - without it no plants can grow and plants supplied with insufficient water become stressed and cannot provide an abundant harvest, no matter how much nutrient they may have.

Countless thousands of books have been written on vegetable gardening, and there is little need to repeat what has been written so many times before. However, the writer has used a few special techniques which he has found particularly valuable in eco-san assisted vegetable production. These include the production of garden compost using organic kitchen wastes, leaf compost, liquid plant foods, seedling production, mulching techniques, worm farming, watering techniques, etc. A few of these are described here.

### **1. Compost making and application**

The compost heap is a familiar sight in most well run vegetable gardens. Compost can be made in piles, pits and every sort of container imaginable (drums, tyres, wooden and brick enclosures, buckets etc). A compost heap is a bacteria and fungus farm which breaks down all sorts of organic matter - with the presence of both air and moisture being essential.

#### **Compost heaps**

These are the most common. The largest component is vegetable matter, with smaller amounts of soil and manure being added in layers. Typically a 150mm deep layer of vegetable matter (chopped up vegetables, leaves, crop residues, weeds, grass, tree prunings, straw, organic kitchen wastes etc.) is laid down first. This vegetable matter is covered with a 50mm deep layer of manure, which can be taken from the urine diverting toilet or from the droppings of various animals (chickens, goat, horse, dog, cattle etc). A thin third layer, about 25mm deep of soil or soil and wood ash is added over the manure layer, then another 150mm deep layer of vegetable matter is added on top and the process of building up the "sandwich" is repeated until the pile is about a metre high. The pile should be kept moist at all times but not wet.

The use of urine as an activator is recommended - it should be diluted with water about 2:1 or 3:1 and applied to the heap. Air vents can be added and ideally the pile should be turned twice during the three month period when the compost is forming. This may be easier said than done. The resulting compost is dug into beds and mixed with other soils to enrich them.





Full compost heap at the Eco-Ed Trust, Mutorashanga. The base layer of vegetable matter has been laid down to a depth of about 150mm and has been covered with a 50mm deep layer of manure (including human). This has been covered with a thin 25mm layer of soil (with a little lime). The next layer is vegetable matter again and the process is repeated. Thanks to Jim Latham and Eco-Ed Trust.

### Compost pits

The same process can be carried out in pits below ground level. In fact, during its first year of operation, the second pit of the *Fossa alterna* can be used to make garden compost. However, it is equally well used to make leaf compost. It can also be filled with a mix of leaves, soil and animal manures and used to grow comfrey or other vegetables. There are many uses of small shallow pits, not least that used for making humus from human excreta, soil, ash and leaves.



The second pit of a *Fossa alterna* in its first year can be used as a compost pit.

## Compost baskets

A simple compost maker can be made from a tube of chicken wire. A piece of 12mm chicken wire 0.9m wide and 2m long is formed into a tube. The ends of the wire can be brought together and the twisted together to make a tube. Such a basket is self supporting if leaves alone are added to make leaf compost, but it will not be self supporting when a mix of vegetable matter, leaves and manure and soil is held within. So four stakes or cut bamboo must be held firm in the soil around the basket to keep it upright. Once the basket is secure, add leaves and a variety of other vegetable matter to the base - about 150mm deep. Then add a layer of manure about 50mm deep (this can include buckets of human faeces and soil taken from the *Skyloo*) topped up by a layer of soil 25mm deep. Fertile topsoil is best. As an activator, a mix of water and urine (about 3:1) can be added when the basket is half full. Then repeat the additions of vegetable matter, manure and soil. Add some more of the diluted urine when the basket is full. Adding some compost from another pile helps. Keep moist by watering with the water/urine mix or plain water from time to time. After about three months the end result should be pleasant-smelling, crumbly dark brown compost which can be applied to the vegetable garden at the rate of a 10 litre bucket full per square metre.



**Chicken wire baskets held up with bamboo poles contain compost - a mix of vegetable matter, manure and soil in layers. Behind there are two similar baskets made of chicken wire which are particularly useful for making leaf compost. The leaves are placed inside the basket with very thin layers of soil added. Often no soil is added at all. They are much lighter when filled with leaves only and do not need support. A very useful size is where these baskets are cut in half and are about 45cm high. The baskets are about 65cms in diameter. The baskets can be scattered about in the garden where the leaves are falling.**

## Cement compost jars

A combination of vegetable matter, thin layers of soil and manure can also be built up in composting jars made of cement. In fact split cement jars (30 litres capacity) are ideal for composting human faeces together with soil (see section on *Skyloo*). Larger 80 litre jars can also be made in cement. A mould made from a plastic dustbin is ideal. The plastic dustbin is cut in half and used as a mould. The two halves of the resulting cement jar, once cured are wired together and the build up of ingredients inside can begin. Vegetable matter (from garden and kitchen), manure and soil are added in layers and watered down. It is this watering which can contain urine - a mix of 3 parts of water to one of urine will help to activate the pile and also add nutrients to the final compost.

The writer has used this method to utilise dog manure in his garden. The dog manure is swept up and added to the 80 litre split cement jar composter. Vegetable matter discarded from the

kitchen and elsewhere is also added and covered with a layer of soil. The compost produced is rich in nutrients as the table below shows. Four such jars have been built and the soil, dog manure and kitchen wastes are placed in each in rotation. It takes a year to fill all four jars, thus the period of composting before subsequent extraction is one year. The compost when mixed with topsoil is an excellent growing medium for vegetables. The ideal mix for growing a variety of vegetables consists of 50% of this jar compost and 50% leaf mould mixed with an equal volume of top soil. 80 litre jars of this type could also accept the buckets of faeces and soil from the *Skyloo* to replace the dog manure. Currently a series of smaller 30 litre split cement jars are used for this purpose and have proved over several years to be perfectly satisfactory for this task.



**80 litre cement composting jars**

### **Nutrient levels in jar compost**

The following table shows how the combination of dog manure and organic kitchen wastes in combination with garden topsoil can be used to make valuable compost. Nitrogen and phosphorus in ppm and potassium (K), calcium (ca) and magnesium (mg) in ME/100gm sample

<b>Soil source</b>	<b>pH</b>	<b>N</b>	<b>P</b>	<b>K</b>	<b>Ca</b>	<b>Mg</b>
<b>Woodhall Road base soil</b>	6.2	27	32	0.63	9.68	2.30
<b>80 litre jar soil</b>	7.2	314	171	1.00	67.38	17.52

When the jar soil is combined with Woodhall Road topsoil, all nutrient levels are increased together with soil texture. It is a good way of getting some benefit out of dog manure!

## **2. Leaf compost making and application**

Leaf compost (sometimes called leaf mould) is the humus-like material formed when leaves decompose. The process takes place in Nature constantly under trees or in the woodland or forest. Forest humus is the complex material originating from the decomposition of both animal and plant residues by micro-organisms. It forms the fertile “forest floor” in which so much life abounds. Humus provides food for bacteria and fungi and also a medium in which they can work. Different groups of microbes are vital for transforming organic residues to nutrients which can be used by plants. Microbes associated with the root system encourage mycorrhizal association - channelling of nutrients into plant roots through the fungal threads. Humus also improves the texture of the soil making it more crumbly and also improves its water and nutrient retaining capacity.



Leaf compost is the end result of a natural decay of leaves and is performed mainly by action of fungi, but there is also some bacteriological breakdown. The normal compost heap in which vegetable matter, manures, and soil are mixed in layers is also broken down as a result of fungal activity, but bacteria are very active in this process and the presence of air is essential.

If plenty of leaves are added to the *Fossa alterna* pit during the filling process, then there may be little need to add any more humus (including leaf compost) to the final mix of eco-humus and soil to make an ideal growing medium for plants. However, if a poor soil is added to the pit, there will almost certainly be a need for additional humus to be added. Leaf compost is one source of humus which is easily made, costs nothing and may be readily available. Its effect on improving the soil, texture and level of nutrients is very significant.

Leaf compost helps to improve the soil by improving its physical characteristics, making it more crumbly and also improving its water retaining properties as well as releasing plant foods into the soil. It is thus a most valuable material and every effort should be made to utilise it in vegetable production associated with ecological sanitation.

### **How to make leaf compost**

Leaf compost can be formed artificially when leaves are stacked up in heaps and watered. Leaf compost can be formed by watering leaves contained in chicken wire baskets, half drums, brick enclosures, pits, plastic bags etc.

If dry leaves are stacked up in piles, or even in chicken wire baskets and left dry they do not change much. Like paper, they retain their characteristic for years. If the leaves are soaked in water they begin to decompose and the temperature rises. It is the fungi (*Ascomycetes*, *Paco Arroy*, *pers.comm*) present on the leaves which multiply and do much of the breakdown of the leaves, but also bacteria are active too. The formation of leaf compost is a relatively slow process because the cellulose in the leaves must be broken down and this takes time. However, there is much variation. The temperature increase varies from one leaf type to the next, and this also relates to the rate of breakdown. Indeed in terms of leaf compost production there is a great variation between leaves, some are easier to process than others. Thinner leaves like bougainvillea and Mexican apple are easy to process and actually heat up quickly when water is added. Temperatures of 60 degrees C can be reached in just a few days, indicating that bacteria are very active in this stage, but are not maintained and temperatures between 20 - 35 degrees C are more common during the formation of leaf compost. Leaves like Kenya coffee, guava and avocado seem to heat up less and take longer to form the leaf mould - they have thicker leaves.

### **Making leaf compost in wire baskets**

This may be the best way of making leaf compost. A piece of 12mm chicken wire 0.9m wide and 2m long is formed into a tube. The ends of the wire can be brought together and the twisted together to make a tube. When filled with leaves the wire basket is self supporting. This tube can be cut in half to make two leaf mould baskets each 0.45m high. The shorter baskets are actually more convenient. Experience has shown that if dry leaves are broken up first then leaf mould production is accelerated. One way is to stack them in the "basket" and pound them with a pole. For the luckier ones, an excellent method is to stack the dry leaves in a pile in the garden and run the lawn mower over them. The technique involves raising the

mower over the leaves and gently lowering the rotating blades over the leaves. They will immediately be cut up. This process is continued until all the leaves are cut up. The volume of cut up leaves may be one third or less of dry un-pounded leaves. It is these leaves which are introduced into the basket and compacted. They are then soaked with water and covered with a sack. Water loss can be reduced further by wrapping plastic sheet around the basket.

Within a day the temperature starts to rise significantly, but the temperature attained will depend on the type of leaf. A mixture of Bougainvillea and Mexican apple leaf was ideal and rose from ambient temperature of around 20 degrees C up to over 60 degrees within 4 days of packing in a basket and soaking. Leaves of Kenya coffee, guava, and avocado only reached temperatures in the 20's having been processed in the same way. Both Bougainvillea and Mexican apple leaves are thinner than the leaves of Kenya coffee, guava and avocado, and thus more easily broken down. The chart beneath provides a temperature chart.

<b>Date</b>	<b>Bougainvillea and Mexican apple</b>	<b>Kenya coffee, guava, avocado</b>
5 <sup>th</sup> August 2002 (5.00pm)	leaves placed in basket	leaves placed in basket
5 <sup>th</sup> August (ambient temp.)	20	20
7 <sup>th</sup> August (8.40 am)	54.6	22.4
8 <sup>th</sup> August (7.00 am)	60.2	22.2
10 <sup>th</sup> August (9.10 am)	56.0	20.9
11 <sup>th</sup> August (noon)	41.9	20.5
12 <sup>th</sup> August (8.15 am)	41.3	22.2
15 <sup>th</sup> August (noon)	38.6	27.1
16 <sup>th</sup> August (5.30 pm)	36.9	26.1
18 <sup>th</sup> August (9.00 am)	27.2	25.2
20 <sup>th</sup> August (9.00 am)	23.2	23.3
21 <sup>st</sup> August (7.30 am)	22.7	22.3
25 <sup>th</sup> August (9.00 am)	20.8	20.0

The rate of leaf compost production is accelerated considerably if the leaves are cut up first and then enclosed in the basket and surrounded by plastic sheet. Leaves can even be contained within large plastic bags within the basket. Whilst leaf compost may take several months to form heaps or even open baskets, if the leaves are soaked and contained within baskets surrounded by plastic sheet or contained in plastic bags, thus retaining constant moisture, the rate of production is increased. An excellent leaf compost made from Bougainvillea and Mexican apple leaves was ready for use after six weeks in the basket surrounded by plastic sheet and after 4 weeks when the leaves were enclosed in a bag within the basket. In both cases the dried leaves had been chopped up before being placed in the basket.

Soil analyses were undertaken on both the leaf compost made in the basket and one processed in the bag. In both cases an excellent leaf compost was made which were very rich in nutrients. Figures for pH, nitrogen and phosphorus in ppm and potassium (K), calcium (Ca) and magnesium (Mg) in ME/100gm sample are shown below.

<b>Soil source</b>	<b>pH</b>	<b>N</b>	<b>P</b>	<b>K</b>	<b>Ca</b>	<b>Mg</b>
Leaf compost (in basket)	8.2	256	344	13.92	29.86	9.42
Leaf compost (in bag)	7.8	267	294	8.50	25.40	6.35

These figures show what a very valuable product leaf compost is, rich in all the important plant nutrients.

### Making leaf compost in steel drums

A 200 litre steel drum can be cut into half and also used as a leaf composter. This method was tried at Woodhall Road with success. Layers of leaves were placed in the half drum and covered with a thin layer of soil and then more leaves were added. A good leaf compost was prepared in about 6 months. This leaf compost was analysed at the soil testing laboratory. Figures for pH, nitrogen and phosphorus in ppm and potassium (K), calcium (Ca) and magnesium (Mg) in ME/100gm sample are shown below.

Soil source	pH	N	P	K	Ca	Mg
Leaf compost (in drum)	7.6	239	255	0.60	40.20	14.80



On left chicken wire baskets used to make leaf compost. This is the most effective method. Water is applied to the leaves to keep them moist. They retain water better if the basket is surrounded by a plastic sheet or sack. It also helps to cover the leaves with sacking or plastic. On the right two half steel drums with leaf compost. Later they were turned into worm farms

### Making leaf compost in brick composter

Bricks can also be used to contain the leaves. These are built up without mortar to form a brick box. The unit used at Woodhall Road measures 0.95m X 0.70m X 0.3m deep. The leaves are stacked in the brick box and watered and covered with newspaper. Within a few days they contract in size and more leaves are added, being covered with the newspaper again. After several months the decomposed leaves can be removed and bagged ready for mixing with other soils used in eco-san and other gardening projects. This leaf compost was also analysed at the soil testing laboratory. Figures for pH, nitrogen and phosphorus in ppm and potassium (K), calcium (Ca) and magnesium (Mg) in ME/100gm sample are shown below.

Soil source	pH	N	P	K	Ca	Mg
Leaf compost (in brick composter)	7.4	540	266	9.00	29.1	12.90

The overall conclusion is that leaf compost is a valuable, and indeed even vital component to eco-san. Obviously where there are no trees there can be no leaf compost, but where trees are growing it is readily available form of humus and also nutrients which are of the greatest



value to the organic farmer. What is so important is that leaves are added to the shallow pits systems used in eco-san - like the *Arborloo* and the *Fossa alterna*. When soil alone is added, nutrient levels of the final humus can rise significantly. The addition of leaves as well, and as many as possible, improves the texture of the final product considerably. In the initial trials of the *Fossa alterna* at Woodhall Road in mid 1999, leaves were added to the pit contents together with soil and human excreta. The humus like qualities of this mix were much appreciated and led to the use of the word “humus” as a description of the product. Without leaves (or other vegetable matter) being added to the shallow eco-pits, the soil produced tends to be similar to the soil added, sandy, clayey grey, dark and light etc. The addition of humus forming matter like leaves provides the extra qualities that good soil requires. Leaf compost added to sandy soils also assists in the conversion of ammonia to nitrate which the plants can use.



**Unmortared bricks stacked up in a box shape make a good leaf compost maker**

### **Use of leaf compost in eco-san**

The final leaf compost is mixed with other soils and also can be mixed with soil from the *Fossa alterna*. An excellent combination is one third *Fossa alterna* humus, one third leaf compost (or other compost) and one third topsoil taken from the vegetable garden. This has been tried in several experiments. The leaf compost provides improved physical properties to the soil as well as providing extra nutrients which are released over time. Another excellent mix is 50% compost jar humus and 50% leaf compost mixed with an equal volume of topsoil. The jar humus can include human faeces as well as animal faeces. In this case it is allowed to compost for one year before use. But the greatest value of leaves in eco-san is when they are allowed to compost in the shallow pits of the *Arborloo* and the *Fossa alterna*. As we have seen they provide many improved properties to the final humus, not least improving nutrient level and air content and thus improving composting efficiency but also absorbing urine which greatly assists in the composting process.

### 3. Liquid plant food

Plants grow best when there is a good balance of nutrients available. According to the organic farmer Lawrence Hills, if you have too much nitrogen available at once, you “lock up” the potassium, as well as wasting nitrogen. Use too much phosphorus, and this too locks up potassium, whilst excess calcium locks up boron. In tomatoes, pale green leaves denote a shortage of nitrogen. Small blue green leaves turning purple show a phosphorus shortage. This is particularly noticeable in rape - the leaves tips or sometimes the whole leaf turns purple as a result of a phosphorus deficiency. This often affects the older leaves and plants have the ability to transfer nutrients from one part of the plant to the other - providing the younger leaves with a higher proportion of nutrients. This obviously only happens if the soil is deficient in nutrients.

Swedish work which is well documented shows how valuable the urine is for providing quite a full range of nutrients (Wolgast 1993, Jönsson 1997 etc). However, some plants, notably tomato and onion and even potato, are known to require quite high levels of potassium and it is useful to investigate methods of bringing these special nutrient requirements to the vegetable garden. The Mexicans (Paco Arroyo pers.comm.) have shown that whilst urine is an excellent source of nitrogen, readily absorbed by plants and essential for leaf growth, when used on deficient soils, there is not enough phosphorus and potassium available, which can reduce fruiting, particularly in those plants which have a high requirement for those elements, like tomato. The Mexicans solved this by employing the red worm (*Eisenia foetida*), which produce castings containing a lot of phosphorus and potassium and also minor nutrients which the plants need and which are not supplied by urine. Apart from garden humus and compost, liquid feeds made from manure, composting leaves and other materials rich in nutrients can be very valuable. The use of supplementary liquid plant food to satisfy the requirements of a wide range of vegetables is therefore of interest. One method is to add wood ash to the soil or even to the liquid feed. The writer has used this method and also turned to the comfrey plant as a valuable supplier of a wide range of nutrients. This can be supplied as a mulch or a liquid feed.

#### The value of comfrey

The comfrey plant (*Symphytum officianale*) has extraordinary properties of being able to gather a wide range of minerals from the ground and hold it in the leaf. The leaves can be used in compost heaps directly or can be used as a mulch. One valuable technique involves making a liquid feed from the comfrey leaves and applying this to plants. There are several methods available. One involves mixing water with cut up comfrey leaves and allowing the mix to ferment. The other involves adding cut up comfrey leaves to urine first, allowing the mix to ferment and then diluting with water. The method with urine is interesting because it produces a product which has the value of urine in it with an extra dose of potassium and other minor minerals.

This method of providing extra nutrients is interesting and particularly valuable for tomato and onion, which require a lot of potassium for the best results and it seems more than the urine alone may provide. Potatoes, beans, cucumber, squash, marrow and peas also require a lot of potassium and this may not be available in sufficient quantities in the urine alone. The urine and comfrey combination ensures that the best use is made of the urine which is a great nitrogen provider and comfrey which is a great producer of potassium. Both products do yield a wider range of nutrients but in differing levels according to Hill.

### 3.1. Making comfrey liquor with comfrey and water

The simplest method is to chop up comfrey leaves and add them to water in a container with a lid and small hole drilled in the lid to let off gas. The comfrey is added at the rate of 1.5 kg chopped comfrey to 20 litres water. The mix is allowed to ferment for about four weeks before use. It can then be applied directly on the soil in which plants are growing. Application of about 0.5 litres per three plants or in a 10 litre container containing the plants three times a week can help the plants.



The comfrey plant is a most valuable addition to the garden. It can be used as the nutrient supply for a liquid plant food, with and without urine and as a mulch. It is an excellent addition to the compost heap. It also has medicinal properties. On the right, cutting up comfrey and adding to water. This will ferment and provide a good plant food.

### 3.2 Making liquid plant food from manure

It is possible to make a liquid plant food from cow, horse, goat or chicken manure. It involves taking a bag of the manure and suspending it in a container full of water. A ten litre hessian bag of manure suspended in a 200 litre drum will work. The manure is bagged and suspended from a string into the water, and left for a week. It is best to cover the drum with a lid to stop any smell or fly problems. After a week the bag is removed, allowed to drain off and the brown liquid in the drum is stirred and then diluted with three parts of water to make the liquid feed. This can be applied to the vegetables with a watering can. The bag of manure can be placed back in a new drum of water and after a week used again diluted with about two parts water. If the bag is used a third time, the resulting liquor can be used neat on the plants. The manure can then be added to the compost heap. This method advocated by Tom Manson (see bibliography), which I have tried, works well. Eventually the bag rots – but a new one can be found.

There are several plant foods available on the market, the one known as Groesia is well known in Zimbabwe and has been available from the Marlborough Nurseries for decades. The secret formula no doubt has liquid manure in it, plus an assortment of additives. Even chemicals are sometimes added to the liquid manures and Manson recommends adding 2kg per 200 litres of ammonium nitrate for green vegetables or one high in potassium for tomatoes and potatoes. In eco-san we try to look for non chemical ways of providing extra nutrients.



### 3.3. Making liquid plant food from leaf compost

This is a simple and effective technique for making a good liquid plant food which can be applied directly to seedlings and young plants as well as more mature plants. It is made by composting leaves of various sorts in a covered bin composter (such as an 80 litre plastic dustbin), which is kept moist by the periodic addition of water from above. In this case the liquor which drains through the composting leaves is directed to a liquor catching tray and retained and can then be applied to seedlings and more mature plants as a plant food. The liquor has the appearance of tea.



**The leaf compost liquor maker**



In the left photo, the leaf compost liquid plant food maker can be seen next to a leaf mould basket covered with a plastic sheet to retain moisture. The liquor catching tray can be seen with the jug inside it. On the right, the liquor catching tray and the inverted metal dust bin lid can be seen more clearly.

It has already been seen that composting leaves have a high content of valuable nutrients suitable for plant growth. The range and nutrient content of the leaf compost can be improved further by adding comfrey leaves which contain a wide range of nutrients including a high content of potassium, which is valuable for plants like tomato, potato and onion. Worms may develop naturally in such a composting pile, and if not can be added artificially. They flourish. So the resulting compost mix contains not only nutrients derived from composting leaves, but also from the worm castings which are also rich in valuable nutrients. Water is added every few days to the mix and the resultant liquor collected. When water is passed through this mix it picks up a valuable range of plant nutrients. The liquor can be used neat or

diluted with water on plants with beneficial effects. After some months the leaf composted can be harvested from the composter and recharged with fresh leaves. The harvested material can be used as a mulch or mixed with other soils before planting vegetables.



The leaf compost liquor maker is filled with semi composted leaves taken from the leaf composter basket and extra comfrey leaves are added (right). Worms can also be added. Those flourishing in this system were not added deliberately, they were already present in the leaf compost. In this case the composted leaves are mainly bougainvillea. Thin layers of soil can also be added.



Five litres of water (from a pond in this case) is added to the top of the composting leaves. This drains down through the mix of leaves and worms. On the right healthy worms living in the leaf compost.



In the left photo, spinach seedlings on the right basins have been fed with the leaf compost liquor and are growing more vigorously than the water fed seedlings in the left basin. In the right photo, healthy spinach have been grown in basins by the combined use of diluted urine (2 treatments of 3:1) and the remaining 6 treatments (2 per week) of leaf compost liquor. The liquor contains less nitrogen than urine, but more minerals of other sorts.





The leaf compost liquor is also excellent for feeding seedlings and can be used undiluted. Here seedling tomatoes which have grown from compost are transplanted into seed trays. They are transferred again to buckets to grow to full maturity. The leaf liquor can also be used to feed the larger tomatoes. The humus formed from human manure invariably contains tomato seeds which germinate when watered.

#### **4. A worm farm**

The writer has made excellent potting soil which is rich in nutrients by farming worms in manure and leaf mould, using leaves placed on the surface as a worm food. Small red worms are used, but in general most worms will do. The technique involved cutting a 200 litre steel drum in half (various other containers, sometimes known as “worm bins” can also be used) and using these to make the “worm farm.”

Holes are made in the base of the drum for drainage. The drum with the open side up, is mounted on three bricks to raise it above ground level. These bricks, surrounded by wood ash, help to reduce the nuisance from ants. A layer of river sand 50mm thick is added to the base of the drum. Then a layer of manure (in this case goat manure) is added about 75mm deep, followed by some leaf mould. Then a hand-full of worms are added. Further layers of manure and leaf mould are added followed by more worms. This layering is continued until the drum is nearly full. Finally the manure is covered with a mix of fertile soil and leaves. The leaves act as food for the worms and more leaves are added to the top of the pile from time to time. The drum is watered down and kept moist from time to time. It should never be flooded with water.

In a few months the worms will have turned the manure and leaves into rich potting soil. They will also have multiplied and new small worms will start to grow. The worms take the leaves down into the manure which turns into a rich and valuable potting soil. The potting soil can be removed in small amounts from time to time as it is required. The worms can also be harvested and used to seed more worm farms.

The earth worm is nature’s farmer. Earthworms are tireless workers turning over the soil, and taking down fresh vegetable matter, such as leaves, from the surface, down into the soil. The burrowing of the worms aerates the soil and the worm’s faeces (worm castings) are also very rich in nutrients. Where earthworms are present in the soil, you can be sure that the soil is good and fertile.





**Worms are Nature's gardeners**

The well researched and widely used art of farming worms to increase soil fertility, known as vermiculture, and its used in ecological sanitation, has been described in many books and magazines. Perhaps the best known is the Worm Digest (email : [mail@wormdigest.org](mailto:mail@wormdigest.org)). A comprehensive list of sources of information is available in the Sanitation Promotion Kit (WHO – 1997 see bibliography).

## **5. Modifying urine as a liquid plant feed.**

As we have seen urine is an excellent plant food rich in nitrogen and is particularly valuable for maize and green leafy vegetables. The technique of diluting with water in ratios of 3:1 or 5:1 and applying to maize and vegetables once or twice a week can produce very positive results. But care is required because of the high ratio of nitrogen compared to other major nutrients. If over-applied, urine can be toxic to plants and is quite capable of slowing down plant growth as well as accelerating it, if the urine is applied in too concentrated a form or when the seedlings are still young. For instance, if young tomato seedlings are planted in potting soil and watered just with water only, the growth will be good. If a 3:1 mix of water and urine is applied to the seedlings which are too young, the growth may become stunted.

It is possible to manipulate the urine to increase the proportion of phosphorus in relation to nitrogen – a technique which may be useful for young seedlings. One technique which has promise, but still needs more investigation, is to sediment out the *struvite* (the mix of phosphorus salts contained in urine) and then dilute these with water. When shaken the sediments rise up in the water and can then be applied as a liquid feed for young tomato.

A technique which I have tried with some success is to add banana skins to the raw urine in bottles and then allow the sediment to form. These skins are high in phosphorus and may help to promote the sedimentation, but I have no proof for this. A second, taller bottle is prepared and a small plastic pipe introduced in the side wall one 6<sup>th</sup> of the way up. This is stoppered or bent to close it off. The urine from the holding bottle is then shaken up to release sediment and poured into the tall bottle and allowed to sediment over a few days. The top 5/6<sup>th</sup> of the urine is then drained off through the pipe and can be used as a nitrogen liquid feed, diluted with water. The tall bottle is then topped up with water and shaken, making a mix which contains more phosphorus and less nitrogen than the original urine. This is shaken up before applying to the soil. I have found this concoction helps the tomato seedlings a lot. However,

the phosphorus in *struvite* is released slowly and its effects are felt over a period of time. The proportion of phosphorus can be increased further by repeating the process. In practice however the plant food derived from the leaf compost liquor maker is easier to make and use.



**The covo seedlings on the upper layer have been given the *struvite* mix as described above. Those covo below have been given water only. An increase in growth of the seedlings can be seen. This may be due to the higher proportion of phosphorus in the *struvite* mix and the greater dilution with water (5:1) compared to the normal diluted urine, (3:1) which can stunt very young seedlings.**

Once the seedling is well established and during the later vegetative stage of growth, the 3:1 or 5:1 water/urine mix can be applied to the plants (leafy vegetable) once or twice a week. In Mexico, a small handful of humus is applied to the raw urine and allowed to ferment. This is also reputed to enhance the properties of the urine as a liquid plant food. It seems there are many ways of manipulating and diluting urine, so it becomes more effective as a plant food. It is also possible to add some single super phosphate fertiliser to the diluted urine mix, about 10 gms per litre of a 3:1 or 5:1 mix of water and urine. This will increase the ratio of phosphorus, with positive results. Also wood ash can be added to this mix (also about 10gms per litre of a 3:1 or 5:1 mix of water and urine. This will increase the proportion of potassium, which is good for fruiting vegetables like tomato. In practice, a teaspoonful of single super phosphate fertiliser can be added to 0.5litres of a 3:1 or 5:1 mix of water and urine and applied once a week to 10 litre containers. This is useful earlier on in that plant's growth. Later on wood ash (to provide potassium) can be applied with the diluted urine. In practice, a tablespoonful of dry wood ash can be added to 0.5litres of a 3:1 or 5:1 mix of water and urine and applied once a week to 10 litre. Wood ash and other sources of potassium are particularly good for tomatoes.

## **6. The usefulness of mulch**

Mulch is the name for material like leaves or leaf compost which are placed over the soil's surface where plants are growing. The advantages of mulch are many. These include reducing water loss from the soil's surface, protecting the soil's surface from baking hard after watering in direct sun, thus increasing aeration, also weed formation is reduced, so the competition for nutrients is reduced - the planted vegetable gaining what the soil can provide. Also the variation on surface soil temperature is reduced and is more moderate – an important factor in hot climates – reducing stress on plants. But one of the most valuable properties of mulch is the extra nutrients it can provide. We have seen how many nutrients there are in leaf compost, and when this material is applied to the surface, the rain or watering will slowly release these nutrients into the soil beneath for plant use. The same applies to leaves which will remain moist in an environment where the plants are being regularly watered. The use of comfrey leaves is a good example. These are cut up and applied to the soil surface around the plant and slowly release their valuable nutrients into the soil for plant use. Comfrey leaves are

rich in many nutrients, notably potassium, so mulching tomato with comfrey leaves can work wonders for the crop. The leaves are placed over the soil around the plant, once the soil's surface has been loosened to help aeration. Mulching is a simple but most effective technique.



The soil in these 10 litre basins of onions have been covered with leaf mulch. The mulch helps in many ways. It conserves water, adds nutrients and reduces weeds. Well worth the effort of applying.

## 7. Growing tomatoes

Most of the techniques described in this chapter can help to grow good crops of tomatoes. Tomato is an important crop, but it is a sensitive plant and special attention is required to get good harvests. Very often harvests may be poor due to disease or to poor management. Tomatoes are particularly susceptible to disease during the rainy season. How can we use recycled human excreta (humus from *Skyloo* and *Fossa alterna*) and our urine to get bumper crops of tomato? This process can be made easier by understanding that the young plant needs soil with a balanced mix of nutrients, but with more generous supplies of phosphorus, early on, to encourage strong root and early shoot growth. At the early stage nitrogen is not required in such quantity, although potassium which encourages the formation of fruit should also be present in adequate quantities. Too much nitrogen can block the uptake of potassium, so at first the application of nitrogen, by urine application, should be avoided. Plant food in the soil (ideally a 50/50 mix of *Skyloo*, or *Fossa alterna* soil with leaf or garden compost) should be sufficient, perhaps with assistance from liquid feeds like leaf compost liquor. When commercial fertilisers are recommended at this early stage, they contain more phosphorus than other nutrients. Only when the flowers have formed and the very young tomatoes are starting to develop, should extra supplies of nitrogen and potassium be given. This can be achieved by applying a pea tin full of wood ash to the soil (about 400mls or 170gms) and digging in. Also urine can be applied to provide nitrogen. Diluted urine (5:1) can be applied at the rate of around 1 litre per week or 100mls neat per week and watered in. Thus the right food should be given at the right time. Then the plants require pruning as they grow and also staking. Regular watering also helps. Let us look at the step-by-step process that can lead to improved crops.

### The right seed and seedlings

The books say that it is wise to get the right seed or seedlings first to get the best crops. Varieties called “*Moneymaker*” and “*Roma*” are known to provide good crops in Zimbabwe, and tomato seeds are generally cheap to buy, and store well. But we can also obtain good seedlings for free when the *Skyloo* is used, as the humus contains many seeds, which germinate when the humus is watered. Several varieties may be present. Try to avoid growing too many tomatoes when the seedlings are free and numerous. Experience shows that it is far better to grow a few tomatoes well, than a larger number poorly.



## Growing tomatoes from seed

Seeds can be planted in seed trays or small pots and they germinate in about a week. They are best planted in potting soil or good crumbly fertile soil. Several seeds may germinate in a single pot and it is best to thin these out so that a single plant chosen from the group continues to grow in the single small container. These are watered regularly and can also be fed with leaf compost liquor. They should be allowed to grow in the seed tray or small pots until they are about 10cm tall. Then they are transferred into a 10, 15 or 20 litre plastic bucket (or other container) with good drainage holes drilled in the base. If small seedlings are growing in the humus derived from the *Skyloo*, these can also be carefully freed, together with some soil attached to the roots and transferred also into small pot or containers, where they can be fed and watered until transferral to the larger bucket (see *Skyloo* chapter). The best time to sow tomato seeds is between August and December, but with care they can be planted any time. If grown during the rainy season, they must be kept under cover and watered artificially.



## Preparing the bucket of soil

It is important to prepare the soil carefully for the tomato bucket. It is generally best to make a mix of either *Skyloo* humus and garden or leaf compost or *Fossa alterna* humus and garden or leaf compost. It is important that fertile soil be used and it must be able to drain well. Soil processed from human excreta will contain a range of nutrients (see earlier chapter) and a good proportion of this will be phosphorus, which is ideal for the early growth of plants. Vigorous development of the root system and early shoot development above ground level depends on their being adequate supplies of phosphorus. It is the nutrients found in the soil which will carry the plant through the first two and important months of its 6 month life. The bucket is filled with the soil mix, perhaps placing a few stones in the base to help drainage.

## Transplanting into buckets

When the young tomatoes are about 10cm high they can be transferred into the bucket soil and watered regularly. One plant is placed in each bucket, best late in the afternoon. Rich soil should be able to carry the plant for several weeks without any additional feeding, but as the plant grows it will benefit from the application of a mild liquid feed like leaf compost liquor. The application of urine (or nitrogen fertiliser) should not take place at this stage. The tomatoes should be placed in a sunny location but sheltered from the wind. Tomatoes also do well under shade cloth. Too much harsh sun should also be avoided. The plants should be well spaced (at least 0.5m apart) and in a place where they get plenty of air circulation. During the rainy season they must be placed under cover, and watered artificially. Avoid overcrowding and allow for adequate air circulation – otherwise fungus disease will develop. A layer of mulch, a few cm thick, made of composting leaves placed on top of the soil within the bucket will also help to retain moisture and will also provide extra nutrients.



### **Early application of liquid feed.**

It is very important that a well balanced diet of liquid feed be given to the tomatoes. At first this can be a mild feed like leaf compost liquor, where water drains through composting leaves to form a liquid. The presence of comfrey leaves in the compost helps a great deal. Comfrey is rich in potassium which the tomatoes require for best fruiting. Urine can be used at this stage, not directly on the soil in which the tomatoes are growing, but by applying to the comfrey plants themselves. Their growth is enhanced and the leaves pick up the vital minerals from both the soil and the urine and these are later released during the composting process. The nutrients are picked up by water passing through the compost to make the liquid feed (see earlier in this chapter). The presence of worms in the compost also enriches the liquid feed. Their excreta (worm castings) is also rich in minerals. The leaf compost liquor is not strong and can be applied undiluted two or three times a week or even daily (0.5 litre per bucket), together with sufficient additional watering to keep the plants healthy. Nutrients from the soil and mild liquid feeds should be able to sustain the growth of the tomato until the flowers start to form between 4 – 6 weeks after transplanting into the bucket..

### **Staking**

As the plant begins to grow it is wise to place a tall reed or bamboo stick (1.5 metres high) in the bucket and tie the main tomato stem to this for support as the plant grows.



### **Removal of side shoots (pruning) as the plant grows**

As the plant grows it is wise to remove some of the lowest shoots and leaves and also those shoots which grow in the axils of larger shoots (see photo). This practice will allow for plant food rising up the stem to feed the most important fruit bearing shoots.



**Lower shoots should be removed (left) and the shoots growing in the axils of larger fruit bearing shoots (right)**

### **Formation of flowers and young fruits**

The formation of yellow flowers and young fruits is an important stage in the life of a tomato plant. When a large proportion of flowers produce developing fruit, it is referred to as a “good set” in gardening terms.



### **Increased feeding after first fruiting**

Once the first few groups of flowers (“trusses”) have formed and the first “sets” of very young tomatoes are starting to grow, the time has arrived to increase the level of feeding. This can be achieved by applying a pea tin full of wood ash to the soil (about 400mls or 170gms) and digging in. Also urine can be applied to provide nitrogen. Diluted urine (5:1) can be applied at the rate of around 1 litre per week or 100mls neat per week and watered in. By itself urine contains too much nitrogen in relation to potassium, so the balance must be adjusted by adding wood ash. According to Tom Manson, Zimbabwe’s expert gardener, the application of wood ash to tomatoes can give “bumper crops.” If too much nitrogen is given without corresponding quantities of potassium, the leaves will grow abundantly with less fruit production. When chemicals fertilisers are applied to growing tomatoes after the “trusses have set” a 3 weekly application of 5gms ammonium nitrate and 7.5gms potassium sulphate is recommended (Moran 1992). This amount of nitrogen (5g N per 3 weeks) can be supplied by



applying a 0.5 litres of 5:1 water/urine mix twice a week – or one litre per week together with regular watering. But the urine alone does not provide enough potassium – as this twice weekly application will only provide about 1 gm of potassium per 3 weeks. The potassium must be gained from other sources. This is where the wood ash is useful. It contains about 10% by weight of potassium, so in order to gain about 6 gms of potassium every 3 weeks, a heaped tablespoon of wood ash is required twice a week for each plant. To make it simple put on a pea tin of ash – one time after the first fruits have set. Experimentation is required if the eco-san gardener is to learn the best technique.



### **Harvesting**

Tomatoes can be picked at any time after they start to turn in colour from dark green to pale green (the fruit will ripen in about one week), or when they are light red to full red. They should not be left on the plants after this stage. If everything goes well a tomato plant can yield up to 4 – 5 kg of fruits.

### **Disease**

Tomatoes are also susceptible to fungus and other diseases, particularly during the rainy season and also to attack by eelworms, cutworm and bollworm. Care must be taken to ensure they are spaced well apart and in a position where they will be well aerated. The leaves should never be watered. Sick plants should be removed and burned. Chemicals are available to control fungal and insect problems, but in organic gardening the use of these is normally avoided.



## Growing tomatoes using the “ring culture” technique

This method involves growing the tomato in a container (like a 20 litre bucket) from which the bottom has been removed. The bucket is placed over another container or layer of river sand. In this case a sealed 10 litre cement basin has been used. This significantly increases the volume of sand/soil/compost in which the tomato roots can grow and can enhance fruit production. Also nutrients added to the system are not all lost by seepage through the base of the bucket - they can accumulate in the bed of river sand. The following photos show this method put into use. The bucket is filled with a 50/50 mix of toilet compost and leaf compost, and watered until small marble sized fruits appear. At this stage extra potash is applied by adding a pea tin of wood ash to the soil. Also from this time urine is applied once a week – one litre of a 5:1 mix of water and urine. Comfrey leaves can be cut up and applied as a mulch to provide extra potassium, reduce evaporation of water and reduce the number of weeds.



The lower container is filled with river sand. The upper container is a 20 litre bucket with the base cut off. Two 10 litre buckets are filled, one with toilet compost, the other with leaf compost. These are mixed and added to the 20 litre bucket.



A young tomato seedling is added to the mixed compost and watered regularly. It is allowed to grow in the compost without additional feeding until marble sized fruits appear.





At this stage a pea tin full of wood ash is added to the soil and mixed in. Also the diluted urine can now be applied at the rate of one litre of a 5:1 mix every week. Otherwise normal watering continues. A mulch layer of comfrey leaves is also added over the soil. This reduced evaporation from the soil and also adds potassium. It also reduces the growth of weeds which would otherwise take up nutrients.



Weekly additions of the 5:1 water urine mix continue together with normal watering. More comfrey mulch can also be added. The fruits are harvested when they start to turn red



## 8. Some examples of growing young trees from cuttings and seed

Many of the most successful fruit trees for planting on *Arborloo* pits can be grown easily from seed or cuttings. These include banana, mulberry, guava, paw paw, avocado pear, mango and many others. Citrus trees are more difficult to grow from seed and will normally be purchased as grafted trees from a nursery. Innovative programmes which promote the *Arborloo* method may also provide not only small material subsidies like divided packets of cement to make a concrete slab, but also tree seeds and/or seedlings. Instructions for toilet construction and use and the planting and caring of trees can also be included in such packages, sometimes called “start up kits.” The young tree or tree seeds can be planted in a suitable container, in preparation for later transplanting, at the same time as the concrete slab is made and the *Arborloo* is built and put to use. This period may extend between 6 and 12 months. By that time the young tree will have become well established in the container and will be ready for transfer to the *Arborloo* pit. It is a good way of starting off the process of uniting sanitation with food production.

### Mulberry

Perhaps the most successful tree to grow from cuttings is the mulberry. This is an excellent tree to start because it rarely fails and grows particularly well of organic pits. It also provides delicious fruit, rich in iron and vitamins A, B and C. There are two types of mulberry, black (*Morus nigra*) and white (*Morus alba*). The black type is the best known and the most tasty.

The method involves cutting a piece of **mulberry** tree branch about the size and width of a pencil. Each cutting should have 4 or 5 good buds on it. Cut at an angle with a sharp knife or cutter. Remove any leaves and plant in potting soil or humus in a pot. Plant so the part nearest to main stem of the cutting is placed in the soil. Keep well watered. After a few weeks new shoots will appear on the cuttings. The young tree can be transferred into a bigger container to allow the roots to extend prior to planting on the *Arborloo* pit. This tree is usefully used in Compost toilet starter kits, as it is easy to propagate in large numbers.



Young mulberry sprouting new leaves 3 weeks after planting the cutting. Once well established, the young tree can be transplanted into a larger container or bag prior to the final transplant into the *Arborloo* pit. (Photo: April 2004). On the right the tree is growing fast in a 10 litre bucket.

## Guava

Guava (*Psidium guajava*) is a tasty, nutritious and prolific fruit bearer and is very hardy. It grows almost like a weed in most parts of Southern Africa once established. Very often young trees will germinate and grow in areas where guava has been eaten and the pith thrown to one side or has just fallen off the tree. Guava can also be grown from seed and this is a good way of distributing the trees in *Arborloo* programmes. But guava seeds do take a long time to germinate

Guava like mulberry and most of the other trees grown on *Arborloo* pits grow into very large trees eventually. The pit should be spaced about 4 - 6 metres apart. The young trees pick up the nutrients left in the mix of composted excreta, soil, ash and leaves. The presence of a good supply of phosphorus is particularly valuable when the tree is young. Also the presence of potassium is particularly valuable for later fruiting. As the tree matures, extra supplies of nutrients will be required and this can be provided by adding diluted urine mixed with wood ash (see *Arborloo* chapter).



A pink fleshed cultivar which has been cut to reveal the seeds. In the region guava fruit ripens between February and April. The seeds should be taken from fresh fruit and soaked in water to remove the fruit pulp. The seeds are dried in the shade (right) and stored in a cool dry place for later planting. It is wise to plant 3 or 4 seeds in a suitable container or potting bag and later thin out the best young tree.



Once established the young guava tree can be transplanted into the *Arborloo* pit. On the right a young Guava growing in a potting bag. On the left a wild sown guava growing in a garden. Where guavas are common in the garden, large numbers of guava seeds become dispersed and grow like weeds. The guava is a tough resilient tree, with delicious fruit and like the mulberry a good choice for the *Arborloo* pit.



## Avocado

Avocado (*Persea americana*) trees grow very large and provide huge amounts of fruit over the years. After eating the fruit take the large seed and plant in a clean deep container with the point of the fruit facing upwards and just beneath the surface of the potting soil. Keep well watered. Some people place the fruits in water and wait for them to germinate. Some seeds may be attacked by fungus which causes root rot and this can be dealt with by placing the seed in water at 50 degrees C for 30 minutes before placing in the soil. Root rot kills trees slowly and can spread to healthy trees. Once well established the young tree can be placed on the filled *Arborloo* pit. Since the trees can grow very large, the pits are best spaced between 8 and 10 metres apart.



Bucket of avocado seeds. On right a seed has germinated in a small container.



Avocados growing in bags from seed originally soaked in water and once germinated transferred to the soil in the bag. On the right more mature avocado growing on an organic pit at the Friend Foundation in Harare.

## Other Trees

Many other trees can be grown from seed including paw paw and mango. The tree of choice is chosen by the family itself, bearing in mind that some trees are easier to grow than others. It is best to consult the local tree nursery or Forestry Department for all details of tree cultivation and care.



## **13. Some special constructional techniques**

Ecological sanitation is partly concerned with building toilet structures and partly with recycling the humus and urine to grow vegetables and other plants. The details of latrine construction and methods of applying the humus and urine to improve crop production have already been described. What remains is a brief description of some allied constructional techniques which are valuable in supporting the practice of ecological sanitation. These include the construction of cement jars in which humus can be formed from human excreta and also cement basins in which plants can be grown. It also includes various low cost pedestals, both urine diverting and non urine diverting. Also low cost ventilation pipes for latrines and hand washing devices. None of these have so far been described in this book.

### **Making cement jars and basins**

The most economical method of making containers that will last year after year (if treated carefully) and be recharged many times is to use off-the-shelf buckets or basins as a mould and cast replicas in concrete. The concrete containers are heavier than the plastic bucket or basin, and thus more cumbersome to move, but in the long term they are very durable, being made of concrete, particularly if they are well made and cured and cared for. Split cement jars can be made of 30 or 80 litre capacity and a good concrete basin of 10 litres capacity. The best shape for growing shallow rooted vegetables (lettuce, spinach, rape, covo, onion) is broader and not so deep, so the concrete basin of 10 litres capacity is possibly best and most economical. The ten litre basin about 38cm in diameter and 14cm deep serves this ideally. Up to 50 ten litre concrete basins, can be moulded from a single bag of cement and river sand. Each basin will contain 2 or 3 rape or spinach plants, 1 or 5 – 10 onions. This is quite an economical way of containing precious eco-humus and using it efficiently for vegetable growth. Maize can also be grown on shallow basins of this type for small scale production. Tomatoes are best grown in buckets.

#### **1. Making a 10 litre cement basin for vegetable growing.**

This method is very simple and effective. The ingredients are river sand and cement. The mould is a standard 10 litre plastic basin. The mixture is 3.5 parts river sand to 1 part cement, using a pea tin container as a measuring device (400ml containing 500 gms cement). Two tins of cement (1 kg) are mixed with 7 tins of sand and water is added to form a moderately stiff but workable mix. The mix can be made in a separate basin. A piece of plastic sheet (from plastic bag) is cut into the shape of the base of the basin and laid down within the basin. The cement is spread and drawn up the inner sides of the basin using hands and trowel. A layer is also trowelled evenly over the base. The cement mix is spread out evenly. Several of these can be made at one sitting depending on the number of basins available. Six is a good number and can be made in less than one hour. Once finished, the concrete work is covered with a plastic sheet and left overnight. The following morning the concrete is watered and left under the plastic sheet for another one or two days. The next morning the basins are turned over, exposing the base, and laid in the sun. This heats the plastic, which expands and the plastic basin mould can easily be lifted off the concrete replica. The concrete basins are then carefully lifted and immersed in water or kept wet under plastic for several more days - the longer the better - to gain strength. Once cured, five 8 - 10mm holes can be drilled in the base with a masonry drill for drainage. With care nails and hammer can also be used to make holes. The concrete basin is now thoroughly washed down and is now ready for filling with a suitable growing medium.



On the left six plastic basins are lined up ready to have the concrete mix added. A disc of plastic sheet has been added to each basin to ease the extraction of the cement basin later. On the right the mix has been made up (2 parts cement, 7 parts river sand and 2 parts water – made into a stiff mix). The mix is trowelled on the base and up the sides and smoothed down. It is then cured over a period of days. Various other photos in this book show the basins in use. About 50 can be made with a bag of cement.

## 2. Making a 30 litre split cement jar for excreta processing or vegetable growing

Where a family is using a urine diverting toilet (*Skyloo*) and processing its faecal matter into humus held temporarily in buckets, the 30 litre split cement jar is a very good option as a “secondary processing site”. The section below describes how a cement jar can be made in two halves (shells) so that it can be used to contain the combination of faeces, paper, wood ash and soil from the toilet - it can also be used to grow vegetables.

A 30 litre plastic bucket is carefully cut exactly in half with a hacksaw blade along a line marked on the bucket. The bottom surface and the top rim are retained to keep the shape of the bucket. In addition it is useful to cut a wooden spacer and attach to the top rim of both halves of the bucket to ensure that the rim keeps its shape. It is best that the two halves cast in concrete on the bucket mould keep their shape and match each other when fitted together. Once cut in half the bucket handle mounts are cut off and trimmed. The outer surfaces of the bucket are then sanded down to roughen the surface slightly. A layer of grease or thick oil is applied to the outer surface. The concrete mix is then prepared. This is a mixture of river sand (3 parts) and cement (1part). A small tin (volume 450mls) containing about 500 gms of cement can be used as a measure. 15 tins of sand and 5 tins of cement are used for each split jar (2 pieces). The cement is applied to a thickness of one centimetre and smoothed down.

The castings are allowed to set overnight and the following morning they are watered and placed under a sack or plastic sheet. They are kept wet for another 5 days mounted on the moulds. Then they are carefully separated from the moulds to provide two halves. The longer concrete (cement/sand mix) is kept wet, the stronger the jar will become. It is best to immerse them in water for another week. The moulds are cleaned down and coated with another layer of grease to make another set of castings. About 18 split cement jars can be made with a single bag of cement. Cement, when properly cured is a very strong and long lasting material and a makes a very valuable container.



**Plastering the two shells of the 30 litre split cement jar on a mould made from a 30 litre plastic bucket. After a few days of curing the two cement shells can be separated from the mould.**

### **Making the lid**

The same mixture (3:1) is used to make the lid. This will require about 3 tins of sand and 1 of cement). A 15 litre plastic bucket is topped up with soil and a sheet of plastic paper is cut and placed on the soil. The cement mix is then added to the top surface about 1.5cm deep and a handle (such as a steel chain link) is set in a raised section in the middle. Only 1 or 2 lids are required, as only one will be filling at one time. The rest will be holding plants or will be empty. Lids are required to protect the excreta from flies and animals.

### **Assembling**

The two shells are placed on the ground together in a suitable place in the garden, possibly in a flower bed. They are then wired together to make the shape of the container. In this case the container is erected so that the broader base is at the bottom. This allows for good drainage from the container. The additions of soil and excreta are then made over some days or weeks. These may be the contents from buckets containing excreta coming from the urine separating toilets or even dog/animal manure. Layers of soil (and leaves) are added between the additions of excreta as the layers build up. The lid is kept in place at all times when the fresh material is being built up. Good drainage is important on containers holding fresh excreta and soil.



**30 litre split cement jars are ideal for processing faeces. The two shells are held together with wire. A lid is made to fit over the jar. Painting makes the jar more decorative.**



### 3. The 80 litre split cement jar

This is made in a similar way to the smaller jar but on a bigger scale. An 80 litre plastic dustbin can be used as a mould. The handles of the dustbin are cut off and the outer surface smoothed down. The bin is carefully marked and cut in half with a saw. The same process is followed as for the 30 litre jar. A thin layer of grease or oil is applied to the outer surface and the mix of river sand and cement made up. The mix is 3 parts river sand and one part cement. In this case 18 (450 ml) tins of sand are mixed with 6 tins of cement for each of the two shells made. The mortar is built up to 15 - 20mm thickness. The curing, removal and further curing are carried out in the same way as for the smaller jar. It is important to allow sufficient time for the cement to cure by keeping it wet for several days under plastic sheet. Once fully cured the two shells are carefully separated from the mould and then wired together with the wider end at the base. A cement lid should also be made to fit the jar. This jar makes an excellent container for composting manure and organic kitchen wastes. If four are made, the processed manure, together with kitchen wastes can be used in sequence continuously, with one being filled with another two processing and the fourth reaching a stage where it can be emptied.



Making the larger 80 litre split cement jar using a plastic dustbin as a mould.



Four 80 litre jars were made and used in rotation to process compost from kitchen wastes and manure

## Low cost pedestals

There are several ways of making low cost pedestals for use in toilets. In each of the methods described here a plastic bucket is used as a mould and insert for the pedestal. That is the pedestal is built up around in the bucket in cement, which acts as a mould, but also the bucket is left in place to provide a smooth surface inside the pedestal which can be cleaned down.

### 1. Very low cost pedestal

There is a pedestal which can be made cheaply from a 10 litre bucket. In this case the base of the ten litre bucket is sawn off and laid wide end down on a sheet of plastic. A line is drawn around the base rim of the bucket about 75mm out. Some strong cement mortar is now made 2 parts river sand and one part cement. This is built up along the inside along the line drawn on the plastic and up the side walls of the bucket. With care this can be done in one sitting. This is left to cure for two nights and then the bucket and its concrete surround is lifted up and turned into a base mould made of wood measuring about 40cm X 40cm. The base is cast in 3:1 sand and cement and left to cure. The seat is formed by the rim of concrete laid around the bucket on the plastic. It can be shaped and smoothed down with sand paper and once it is dry painted with an enamel paint. This is really a low cost but practical method of making a pedestal with easy to wash down plastic insert.



Very low cost pedestal made from a ten litre plastic bucket and cement only. It is durable and with suitable painting can be made very smart.

### 2. Low cost pedestal with concrete seat

This method uses a 20 litre bucket - and to reduce cost - a seat made of concrete. In this case a mould is first made in concrete for the seat. This is made by mixing cement and river sand (about 1:3) and building up a "slab" about 50 mm deep inside some bricks (dimensions about 50cm X 60cm). The commercially made plastic seat is then pressed into the cement and held down with a weight. It is left there until the concrete is stiff and then the plastic seat can be removed, leaving an impression of the seat. This should be done with care. It may be necessary to finish off the mould with a small trowel to get it smooth. The mould is left to cure for a week, being kept wet at all times. Once cured and dry, it is smoothed down with sand paper. Then it can be used to make more concrete seats. These are made by taking very thin plastic sheets and covering the seat part of the mould. A very strong mix of river sand and cement (2:1) is then used to fill the depression to make the seat.





The toilet seat mould is covered with very thin plastic sheet and a layer of high strength concrete is laid in the depression which will form the toilet seat. A loop of wire is laid within the concrete. After levelling off, L shaped wires are then inserted into the concrete. An upturned plastic bucket (with base removed) is then placed over the mould with the wire arranged around the outside of the bucket as shown above. Cement is then built up around the sides of the bucket. The wires strengthen the cement work.

A loop of wire is introduced to provide strength. L shaped wire inserts are now placed in concrete to strengthen the link between the seat and the side walls of the pedestal. This is done by laying the wider end of the 20 litre bucket (with the base already sawn off) on the seat. L shaped pieces of wire are then introduced into the cement around the rim of the bucket. The bucket can be left in place whilst the seat cures. Next a layer of strong cement mortar (2 parts river sand and one part cement) is built up around the bucket till it reaches the top. This is left to cure overnight and some thin wire is wrapped around the cement work (in a spiral form) and another layer of cement is applied. This is left to cure for another day or two, then the seat and the side walls of the pedestal can be removed. The pedestal (right way up) is then mounted within a wooden base mould (dimensions - outer 50cm X 50 cm - inner 40 cm X 40 cm) and the space between the wooden mould and the side walls of the pedestal are now filled with a 3:1 mix of river sand and cement with some wire reinforcing. This left to cure for another few days being kept wet at all times. Once cured and washed down, the pedestal seat can be sanded down and any small holes filled with neat cement slurry (nil) and then allowed to dry. The pedestal is then painted with an enamel paint and put to use by cementing in place within the latrine.



Very low cost and durable pedestals can be made with off-the-shelf plastic buckets and cement. With care and paint they can be made into very attractive units.



### 3. Low cost pedestal with plastic seat

This is easier to make and smarter, but more expensive. A commercially made plastic toilet seat is required. First holes are made with a hot wire in the supporting plastic ribs under the seat, so that a ring of wire can be threaded through under the seat. The “hollow” under the plastic seat can then be filled with a strong 2:1 river sand/cement mix with the wire inside. At the same time the 20 litre bucket (with base sawn off) is placed over the seat in a central position and L shaped pieces of wire inserted around the rim of the bucket into the cement. This is left to cure for a few hours. Then the side walls of the bucket can be covered with a 2:1 sand/cement mix. This is left to harden a little. Later some thin wire is laid spirally up the side walls of the pedestal to strengthen the unit. A further layer of mortar is then applied to the side walls. This is left to cure, being kept wet at all times. The pedestal is then overturned into a base mould made of wood, and the base made with more strong concrete - and left to cure. This procedure makes a neat, comfortable and long lasting pedestal.

#### Sequence of making pedestal



Finally a strong durable pedestal is made

#### 4. Home made urine diverting squat plate

Squatting is the preferred position for defecation over much of Africa. It therefore makes sense to use a squatting type urine diverting device, if urine diversion is the chosen method of taking up ecological sanitation. The urine diverting squat plate is used almost universally in China and commercially made units are also available in Kenya. A home made copy of this effective unit can be made using off-the-shelf buckets and cement.



**Make a mould in wood to make a small concrete slab 60 cm long by 30cm wide. Before pouring concrete cut a ten litre bucket, using the lower part to make rear squat hole, 20 cm wide and the upper part of the bucket to make the front hole (about 23cm wide) for later insertion of urine receiver. The strong concrete mix can be made from 3 parts river sand and one part cement. Reinforcing wires are laid in the cement for additional strength. This is left to cure for a few days, being kept wet after the concrete has set.**



**To make the urine receiver, take another 10 litre bucket and drill hole in lower end and attach a small 20mm plastic pipe fitting. This can be attached by welding the plastic or by using an epoxy adhesive. The bucket is cut so the upper edge at the front is higher than the rear. The rear edge should be at slab level.**





Before the bucket is finally cut, it is inserted in the front hole of the slab and tilted so all urine will drain into the urine exist hole and the forward part of the bucket is higher. The bucket is marked and cut and then placed in the hole and strong cement mortar is laid all around the bucket on top and beneath. This is also allowed to set and cure.



1. After curing the unit is allowed to dry and is painted with an enamel paint. Note the side view of the unit on the left photo. See how the front of the urine collector is raised and the rear is low allowing good drainage of urine into the urine pipe. A raised front end catches urine better. The great advantage of the urine diversion squat plate is that males can urinate whilst standing above the unit. This offers a larger target for urine compared to most urine diverting pedestals. It is important however that males urinate in the correct hole. The urine diverting squat plate is fitted over a concrete slab in which a rectangular hole of suitable size has been made. Cement work does absorb urine, so the cement parts should be well protected with enamel paint.

## 5. Home made urine diverting pedestals

This can be an adaptation of the pedestals which have been described earlier in which a urine diverter, made from a plastic bucket, is inserted in the front part of the chute of the pedestal. This urine diverter can be attached to the main bucket of the home made pedestal by welding, gluing, bolting or by wiring.

There are many ways of doing this, the main aim being to catch and divert as much urine as possible so it can be piped to a plastic storage container. The faeces can then drop into the vault below.





In this method a piece of plastic from a bucket is bolted to the side wall of the larger chute bucket to make the urine diverter. At the base of the diverter a polyethylene pipe is fitted in place with epoxy putty. Urine passes down the diverter, through the pipe into the urine storage vessel. This plastic unit is then built up in cement and a seat is fitted as described earlier.



In this method the urine diverter (yellow) is made from a 10 litre bucket and fitted inside the larger chute bucket (25 litre) with wire straps. These wires pass through the plastic and later cement work. The rest of the pedestal is then built up as described earlier. A plastic pipe fitting is then attached to the yellow bucket to lead the collected urine into a urine storage vessel.



On the left the completed urine diverter fitted to a Skyloo. The bucket which collects the faeces, soil and ash can be seen directly beneath the pedestal. On the right a home made urine diverting pedestal made in Kenya.



Once again a 10 litre bucket is cut to shape as shown to make a urine diverter which can fit into a standard (non urine diverting) pedestal as described earlier. A urine outlet pipe is fitted through a hole made in the bottom of the urine diverting bucket. When fitted on to the pedestal, the bottom of the urine bucket is sloped so that urine drains towards the outlet pipe. On the right the wire loops formed in the pedestal to hold the urine diverter. These can be fitted when the pedestal is being made or threaded through holes drilled later through the bucket and cement work.



A side view with the pedestal upside down showing how the lower part of the urine diverter slopes downwards so that urine will drain into the pipe. The lower part of the urine diverter must be able to pass through the hole made for the pedestal in the slab in such a way that the pedestal itself sits on top of the slab. The part of the diverter which holds urine before it drains through the pipe is actually held underneath the slab. On the right the finished urine diverting pedestal.

### Method of making a urine diverting pedestal with urine pipe above slab level

Normally the urine diverting pedestal directs urine into a pipe which is held beneath the toilet slab or floor. In this way the pipe is protected and is able to safely lead the urine either to a soak pit, into a garden or a urine collecting chamber made of plastic. Great care is required to ensure that the pipe allows urine to flow freely downwards to avoid air locks occurring in the pipe, as these can cause problems with the free flow of urine from the diverter to the collector. When a double vault system is used, care is required in disconnecting the urine pipe linked to one vault with the urine pipe of the second vault.

These problems can partly be overcome by making a urine diverting pedestal where the urine outlet pipe is placed above the floor or slab level. Thus it is possible to connect a pipe directly to a fitting on the pedestal and lead the pipe away and to the rear above ground. This method is particularly suitable where the urine diverting pedestal is placed over a shallow pit toilet. Once the pedestal is fitted on top of the toilet slab, the urine pipe can be led away to the rear of the toilet and direct urine either into a seepage area around a tree, or vegetable garden or into a urine container which can be dug in a shallow hole below ground level.



## Sequence of making a urine diverting pedestal with urine outlet pipe above slab level



The material requirements are a 20 litre plastic bucket, a 20mm polyethylene bend, a plastic toilet seat and cement, sand and wire. First the base is sawn off the bucket squarely.



Next the plastic base of the bucket is sawn in two, one of these halves will be used to make the urine diverter within the bucket.



The half base is fitted within the bucket about half way up the walls at an angle. It is secured in place by drilling small holes through cut base and bucket walls and passing wire through and tightening.





A hole is drilled through the bucket wall just above the base of the urine diverter. The 20mm polyethylene bend is fitted through the hole as shown. It is placed at the angle shown above.



The toilet seat is now prepared. Using a hot wire, holes are drilled through the plastic ribs which support the seat. These allow a wire to be threaded in a loop under the seat.



A strong mix of concrete using 3 parts river sand and 1 part cement is mixed and added to the toilet seat as shown. This will add strength to the seat and form a bond between the seat and side walls of the pedestal. The bucket is now fitted centrally over the toilet seat as shown.



8 pieces of bent wire are now introduced into the cement supporting the seat. This is allowed to cure overnight. Next a further mix of 3:1 sand and cement is made and plastered half way up the walls of the bucket. This is left overnight again to cure.



The following morning the upper half of the bucket is cemented with a 3:1 mix and allowed to cure overnight. The next morning the bucket and seat are overturned into a base mould made with wood, about 60cm X 60cm and 40mm deep. It is laid over a plastic sheet.



The base mould is filled with the same 3:1 river sand/cement mix. Some wire is added to the base. Also some thin wire is also coiled around the pedestal. Next a final layer of 3:1 mix is plastered up the side walls of the pedestal over the wire. The final layer can be made with cement watered down to make a thick paint and is applied with a brush. This is allowed to cure for several days being kept wet at all times. It is covered with plastic sheet and sacking.



The space between the bucket side wall and urine diverter is now sealed. Any type of pliable putty can be used for this job. Even chewing gum will do. It is pressed into the gap from underneath first. The putty should also be pressed into the gap from the upper side too. Urine passing into the urine diverter should find its way through the plastic bend and through the plastic pipe.





The urine outlet pipe has been added to the polyethylene pipe bend. This is led back over the concrete base of the urine diverting pedestal to the rear of the toilet.



The pedestal can be made more attractive by coating with enamel paint once the concrete is completely cured and dry. Once dry it can be mounted into the toilet.



The urine diverting pedestal can be fitted into a single or double vault dehydrating or composting toilet. It can also be fitted over a shallow pit toilet. The urine pipe can be led into a soakaway or into a vegetable garden, preferably beneath ground level. It can also be led to a tree like a banana, as shown above. The urine can also be led to a plastic container placed in a hole dug in the ground. It is advisable to protect the pipe in some way by covering with soil etc. Here the pipe is exposed for the photo.

### Final note on this method

Where the urine is led through the pipe to a tree or vegetable garden, it is possible to add more water through the urine diverter to cleanse the pipe and dilute the urine. When the diverter is used over a shallow pit toilet, it is advisable to add soil and ash to cover the deposit to encourage dehydration. If composting is required in the pit, as in the *Fossa alterna*, the pit contents must be moistened by adding urine or water, with soil and ash and preferably leaves.



## 6. Home made vent pipes.

A vent pipe is a valuable part of any pit toilet. It draws out air from the pit, mostly by the action of wind blowing across the top of the pipe. The air that flows out of the pipe is replaced by air passing down the squat hole or pedestal. This is most efficient when the slab and pit collar are sealed and airtight. The effect is that any foul odour from the pit does not escape into the structure, but is diluted by air and passes out of the pipe into the atmosphere. The effect is that the toilet becomes almost odourless. The other property of note is that, if the top of the pipe is screened with a corrosion resistant screen made of aluminium or stainless steel, and the structure is fitted with a roof, the pipe also acts as a flytrap. Where the interior of the toilet is semi dark, flies will enter the pipe from inside and are trapped. This is because flies are attracted to light when they leave the pit and enter the pipe which is the most obvious light source. From the outside, flies are attracted by odours coming from the pit and most of these are expelled through the head of the vent. If the head of the pipe is screened, they cannot enter the pit. This simple effect can dramatically reduce fly breeding in the pit toilet and thus reduce the passage of fly-borne disease. So the vent helps to reduce fly breeding and odour. Toilets fitted with a vent are generally known as VIP's (ventilated pit latrines). There are over half a million in Zimbabwe alone.

Even on shallow pit eco-toilets like the *Arborloo* and *Fossa alterna*, venting helps. Whilst the addition of plenty of ash and soil, helps to reduce odours and the potential for fly breeding considerably, the action of the pipe also helps to remove excess moisture from the pit chamber, as well as removing odours and reducing fly breeding. Vent pipes can be made from bricks, steel, asbestos and PVC. Asbestos is more durable than PVC, and the most efficient are smooth walled round pipes, asbestos and PVC being the most common. 110mm is a minimum acceptable vent diameter, although 90mm may just pass for eco-toilets which already have some degree of fly and odour protection from the regular addition of soil and ash. Commercial pipes are very expensive, but there are ways and means of making them at the homestead.

Several methods are available, one being the use of hessian cloth (sacking) soaked in a mix of cement and sand (ratio 1:1). The cloth absorbs the cement slurry which is best cut into strips about 10cm across. The slurry filled strips are then wrapped around a suitable mould. This can be made of a wire or reed tube or even a bundle of grass suitably wrapped. Alternatively a PVC tube can be used as a mould to make many cement pipes. In this case the PVC tube is covered with plastic sheet and the hessian strips wrapped around it and spiralled up the tube. Four lengths of thin wire (about 2 – 3mm thick) are then placed down the length of the pipe and held in place with thinner wire. Then the strips of cement filled hessian are then wound spirally back down the pipe again with strips overlapping. The final layer is painted with the slurry using a brush. It is left to set overnight and then made wet in the morning and covered with plastic sheet. The pipe is kept wet for at least 7 days before it is moved. The PVC pipe is then twisted out of the cement pipe and the plastic sheet extracted. A suitable screen is then fitted by wrapping around the head of the pipe and fixing with wire. Plain steel screens corrode quickly and are of little value in fly control. Aluminium screen is best. If well made and cured, such cement pipes are very strong and durable – far more so than PVC.



A durable home made vent pipe constructed from Hessian and a sand cement slurry with some wire reinforcing. Very effective and longlasting.

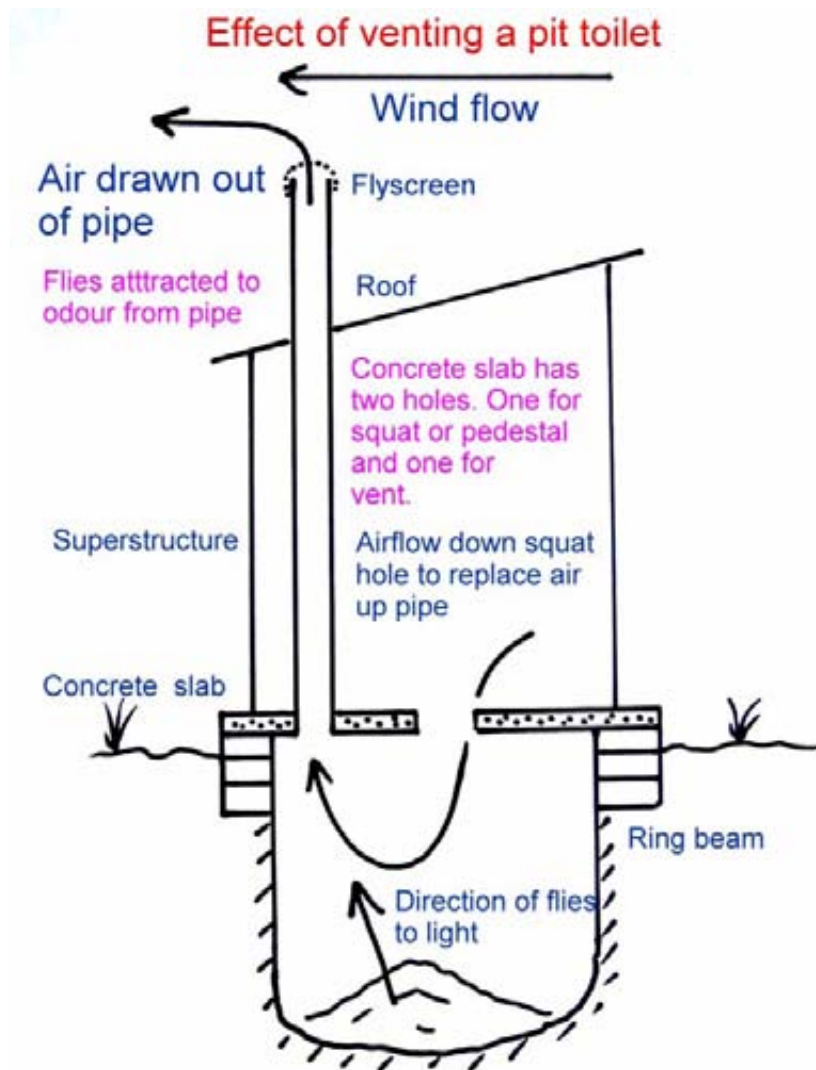

## **A steel framed superstructure for use on a range of on-site toilets**

We have read in the book about the huge range of superstructures which can be used with these eco-toilets. Grass and poles through to brick, or iron sheet. All work, their primary aim is to provide privacy. One particular technique has proved itself to be particularly adaptable to a wide range of conditions and is described here. It consists of a light steel frame welded together using a combination of 25mm angle iron and 25mm flat bar. The durable hinge is made from old car tyre. The roof panel is covered with chicken wire and then a plastic sheet. Grass can be placed on top or thin iron sheet. The walling can be covered with any suitable material, which can include grass, reeds, plastic sheet, sacking or hessian, thin plywood or even wooden slats or other timbers. Whilst the frame is not particularly low cost (the steel costs around US\$50 and a similar amount for labour), one made it will last a family for many years and can be covered with locally available materials which can be collected freely or cheaply.



**Front and side views of the superstructure frame covered with grass**



**Rear view of structure and close up of carrying handle and rubber hinge**





**Close up of hinge and carrying handle and arrangement of steel work.**



**Close up of upper parts of the frame and roof**



**The asbestos pipe passing through the roof and a neat seat made from a bucket and concrete work only.**

# The frame dimensions

## PORTABLE STEEL FRAME SUPERSTRUCTURE FOR FOSSA ALTERNA & ARBORLOO

MEASUREMENTS IN CMS

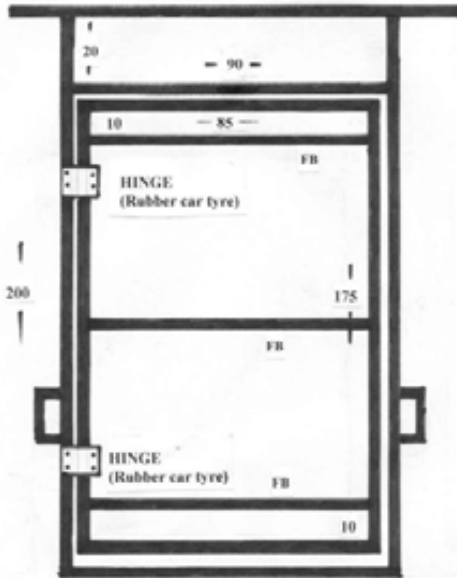

FRONT VIEW (WITH DOOR)

SIDE VIEW

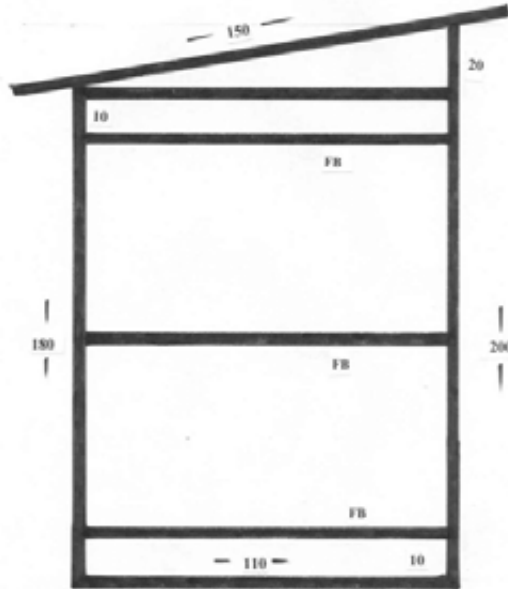

ANGLE IRON = 3.5mm X 25 X 25mm

FLAT BAR = 3.5mm X 25mm

REAR VIEW

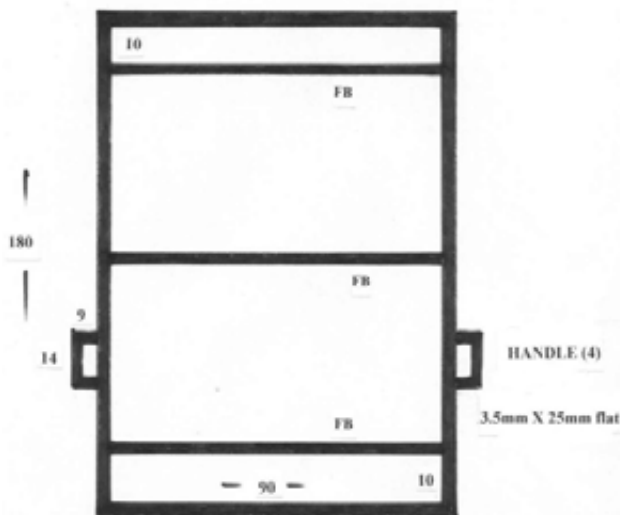

Painted with Red Oxide

FB = FLAT BAR  
ALL OTHER ANGLE

ROOF

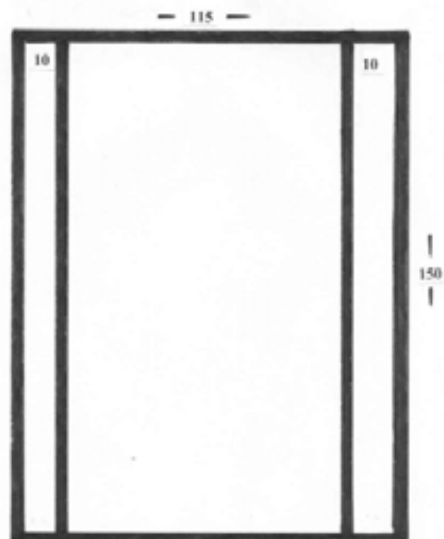

Cover roof with chicken wire and plastic sheet and grass

## 6. Hand washing devices

Hand washing facilities are vital if any hygienic value can be expected out of a toilet system. Hand washing is perhaps the most vital part of the process of improving personal hygiene. In fact hand washing is essential if an improved state of health is to be achieved in relation to toilet use. So all eco-toilets (and any other toilet) should be fitted with a simple hand washing device. There are several ways of making them.

### 1. Using a 5 litre plastic oil container and pill bottle.

In this design a discarded pill bottle and an old 5 litre plastic oil container are used.



Hand washing device made from an old 5 litre oil container and pill bottle

The pill bottle is chosen to fit into the neck of the oil container. Cuts are made in the pill bottle lid and side wall as shown - one in the bottle cap, one in the bottle base and a 2mm hole is also drilled - see photo. The 5 litre container must be suspended on a wire or string so that it is balanced. A hole is drilled in the handle section and the container suspended on a wire placed through this hole.



The container is then thoroughly washed out and filled with water and the modified pill bottle



inserted in the neck of the container. When the water container is tilted forwards, water will flow into the pill bottle through the cut made in the lid and slowly drain out of the small hole. The second opening in the pill bottle allows air out of the bottle whilst water is entering. Otherwise there would be an air lock. The small amount of water released is sufficient to wash the hands - one or two charges may be necessary. There are several variations on this theme of putting together a novel hand washing device using discarded plastic containers. Local innovation is required. There is no end to the variation of design.

## 2. The Mukombe hand washing device

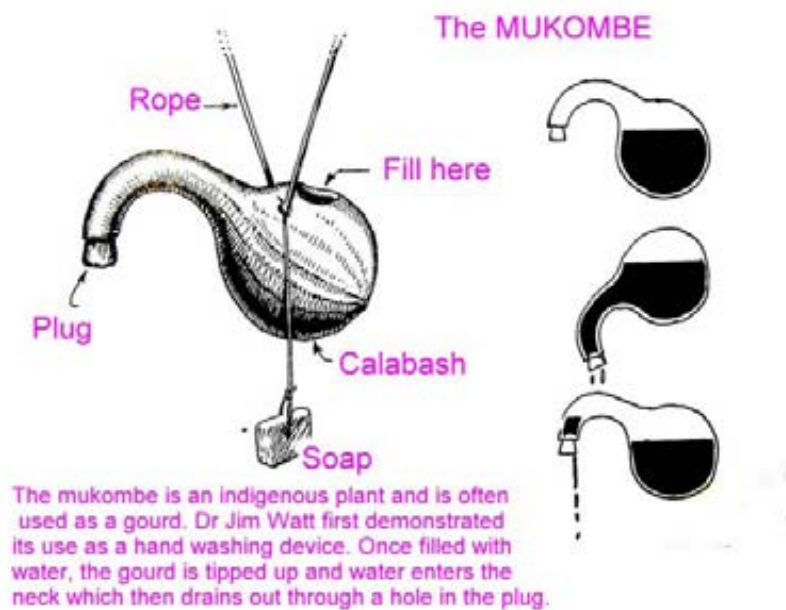

## 3. The milk bottle hand washing device



Another type of hand washing device made from a milk bottle. In this case the lower part of the neck of the handle is blocked off and a small hole drilled above this level. The device hangs on a string attached to a wire passed through the bottle. When the bottle is tipped up, water enters the upper side of the handle and drains out through the hole.

#### 4. Making a hand washing facility from a plastic bottle and “ball point” ink tube.

The discarded ink-carrying plastic tube from an old “ball point” (biro) pen can be used here. A 50mm section is cut off with sharp knife at an angle. A 2 litre (or another size) plastic water bottle is taken with a screw top. The bottle should be round. A small hole is made in the lower part of bottle with a thin hot wire and then the plastic “ball point” tube is pushed through the hole. It should be a tight fit. The bottle is now suspended in some way - with wires or strings near the toilet. The bottle can also be laid on a shelf or laid on a hand washing basin. The bottle is filled with water. There are two ways of regulating the discharge of water through the “ball point” tube. The first way is to release the water by unscrewing the top and thus allowing some air in the bottle. This will release some of the water through the pipe. The water flow will stop once the top is screwed up tight again. The second way is to find a small wire, grass or thin piece of wood which will act as a stopper when placed in the “ball point” tube. This can be attached to a piece of string. Water is released by removing the stopper and replacing after hand washing is complete. It is a very simple and effective device which can be made at “no cost” since all the parts are “throwaways!”



Take a plastic bottle with a screw cap. Make a hole near the base with a hot wire. Next take an old used ball point ink cartridge. Cut a section at an angle about 30mm long. Push the section of ink cartridge into the hole. Experiment so it makes a tight fit. Fill the bottle with water, and close the cap. Water will be released when the cap is opened and sufficient to wash the hands. It is an economical way of using precious water to wash the hands which can carry disease. The pipe regulates the flow of water.



All hand washing devices should be provided in some way with soap or some other hand washing material like wood ash which helps to clean the hands properly. The soap can be suspended from a string passed and tied through a hole drilled or cut through the soap.

***Clean hands for Health!***

## 14. Summing up

This book has described the fundamental principles of ecological sanitation and provided a detailed description of how to build and manage a small range of lower cost eco-toilets where the recycled products can be put to good use. Ample evidence has been provided for the value of both humus derived from human excreta and also the urine for enhancing the production of a range of food crops. The greatest effect is normally achieved by combining the use of both humus and urine. Methods of growing vegetables using recycled human excreta have also been described. The importance of combining the use of recycled human excreta and other recycled organic materials like garden compost has also been emphasised. A number of gardening and constructional techniques which assist eco-san based projects have also been described. The health implications of using processed human excreta, has also been summarised.

The techniques described here cover only a very small, and as yet little known range of on-site options for lower cost sanitation. Many large scale projects based on ecological sanitation are being undertaken around the world and these are receiving much attention. The techniques and methods described here are less well known and intended for use by poorer members of the community, who may in the past have used only the pit toilet or no toilet at all. However it is this proportion of the world's population which is perhaps the largest, the least served and the most in need of improved facilities. It is hoped that this extended range of lower cost options will help to increase the coverage of this underprivileged segment of the population.

Ecological sanitation can also assist where people have used conventional water born systems like the flush toilet before, but where these systems are failing due to a lack of water or lack of maintenance of sewage processing systems. Overburdened or poorly maintained conventional sanitation systems can also pollute the environment considerably. These conditions apply mostly in the cities and peri-urban areas surrounding these cities. Where there is space, the systems described in this book may be useful. There are many projects currently being undertaken all over the world, where these same basic problems are being addressed by the application of ecological sanitation. GTZ and Sida/EcoSanRes are at the forefront of such work internationally.

There are a few central themes on which this particular approach to low cost sanitation, described in this book, has been built.

- \* The toilet system itself must be thought of, not so much as a disposal system, but as a processing unit.

- \* Soil can provide the all-important link between the toilet system and agriculture. In the toilet systems described in this book, soil is added to the toilet in quantity – approximately equal to the volume of solid excreta added. And for best results, the added soil should be combined with wood ash and leaves.

- \* The added soil, together with its companion ash and leaves, converts, purifies and otherwise hastens the conversion of the foul and dangerous mass of excreta into humus, which becomes pleasant to handle, relatively safe and is rich in nutrients. The process is entirely biological, with beneficial organisms of all kinds tending to thrive and pathogenic organisms tending to die out. The inventor of the process is Nature itself.



\*The end result of this natural process is a valuable humus-like soil, which can be used to enhance the growth of both trees and vegetables. Excreta, soil, ash and leaves are abundant and cost nothing. In combination and when processed they have great value.

\* The processing of human excreta (both humus and urine) is best integrated into a broader scheme of recycling all organic products in both the home and the garden.

Ironically this method of using soil to process excreta was first used in the form of the “earth closet” over 100 years ago. This technique preceded the use of water born sanitation as we know it today. The concept of using earth, rather than water, quickly went out of fashion however, after the invention of the flush toilet. As we have seen the “earth closet” and its variants still have considerable merit and greatly deserve revival.

All organic material can be composted. Thus leaves are recycled by making leaf compost. Organic vegetable matter, derived from both kitchen and garden are recycled to make garden compost. Manure derived from animals is recycled to enter the compost heap. The composted materials from all sources, of both animal and plant origin, are applied back into the soil, which becomes enriched. Thus it is the combination of recycled leaves, manure, vegetable matter, kitchen scraps together with recycled human excreta which are used to form a medium which is mixed with topsoil to enhance the growth of food crops.

Put simply, eco-toilets form part of an ecological approach to managing the garden and home in a holistic way. Even used water (grey water) can be recycled in such a way that it can enhance the production of food. The home and garden becomes part of an eco-home and eco-garden. Recycling in all its forms is encouraged. That is how Nature works!

The question then remains, what if I am not a gardener and have no interest or time to produce my own vegetables? Many may have no garden, but this will rarely apply to those for whom this book has been written. If this is the case, these eco-toilets will at least save water if the alternative is a flush toilet. If the alternative is a deep pit toilet, this new approach will provide an alternative facility which is safe, relatively cheap and pleasant to use. The fact remains that all pit toilets will eventually fill up and must be replaced sooner or later. For those millions who use pit toilets, low cost eco-toilets may provide a good answer for the future. For many, it will be the low cost of the simpler toilet systems described in this book which will have the greatest appeal. For others, it will be the ease of construction and the possibility of self sufficiency which will appeal. For others, the selling point may be that for the first time a toilet can do more than just dispose of excreta.

There is also the possibility that once put to use, the production of humus from the eco- toilet, together with the re-use of urine, may encourage the home owner to consider growing vegetables or enriching flower beds or growing more fruit trees. My own interest in gardening and the organic approach was much encouraged when I started to use an ecological toilet and reused the humus formed and the urine.

In this study I have been constantly amazed by the conversion process - how all these materials which in their prime state could never be classified as soil, easily turn into a product which can only be described as soil. Thus leaves turn into soil, organic wastes from the kitchen turn into soil, vegetable and manure turns into soil and even human excreta turns into

soil. Soil is surely the beginning and the end of it all. In this discipline, the answer does indeed lie in the soil.

But even the richest soils need rejuvenation when they have yielded their nutrients up to the growing plants and a method of constantly re-introducing the nutrients derived from urine and humus into the soil is required. Thus compost or processed manure should constantly be introduced into the vegetable garden. Where jars, basins or other containers are used, once the vegetables have been harvested, the used soil can be tipped out into a pile, sieved and introduced into a fresh pile of soil to which fresh compost or eco-humus is added. So there is constant rejuvenation of the soil which is used.

I subscribe to the view held by Louis Bromfield, that there is nothing wrong with carefully combining different techniques in the garden, provided that the soil is enriched, biologically, and plant life is helped to flourish. And careful use of organic and even inorganic plant foods, even those available on the market can also be used carefully in combination with the methods described.

## **Conclusions**

This book attempts to provide practical information which will allow those living in rural, peri-urban and even some urban areas of Africa to build and practice the art of recycling nutrients from their own excreta in order to gain better crops and vegetables in their own back gardens. The work is primarily intended for use in East and Southern Africa, where there is space, where back yard gardening is practiced and where the climate is warm and wet seasons are interspersed with dry.

The basic principles outlined in this book are the most important. These principles can be adapted to suit local conditions in various countries in the sub-region. The method chosen will depend on several factors, not least the amount of money available to build a facility and the willingness of the user to engage in the practice of recycling.



*Eco-toilet in an African setting. Ruwa, Zimbabwe*

It should be remembered that all these eco-toilet systems require a degree of management which is far more demanding than required by users of the normal deep pit latrine or even the

flush toilet. This may not always be clearly understood at first. Thus practical hands-on training and demonstration are vitally important. Often judgements about final design and processing methods may be taken only on-site where soil type, ground stability and drainage have been assessed.

The methods described in this work represent new ventures into the world of low cost sanitation, and there is still much to learn. This work has been written by a researcher, who dabbles at the fringe of understanding. There is an ocean more still to learn. The methods described are intended to add on to the sanitary range of options already available and not compete with them. The pit latrine, currently the commonly used excreta disposal system in the world, has survived over the centuries because, along side its many potential deficiencies, it has great merit. The flush toilet and related waterborne systems have brought with them the possibility of people living together in cities, and of greatly reduced incidents of disease which has made modern life possible. Thus the application of waterborne systems made possible a huge rise in living standards for countless millions of people. And this continues to be the case. All sanitary systems have their place. Both the pit and flush toilet systems will remain as major excreta processing systems for as long as we live. They will be joined by urine diverting systems and variants of both the flush and pit toilets which make recycling possible.

One thing has become clear to me, since I have undertaken this work. This new approach to sanitation has come just in time to add a new perspective and dimension to sanitation itself. The low cost alternatives described in this work, offer really practical solutions for providing acceptable sanitation on a small budget. Very often it is the simplicity, ease of construction and low cost of a method which may appeal at first to the user. The additional benefits of recycling may only become apparent later on. Such an awakening takes time.

***ONLY TIME WILL TELL!***

***Peter Morgan  
Harare***

***July 2004.***



# *The Arborloo Book*

*How to make a simple pit toilet  
and grow trees  
or make humus for the garden.*



*Written by Peter Morgan*

# ***Introduction***

***Most of the rural population of Africa do not have access to safe and reliable toilets. A good toilet, together with a safe reliable water supply and the practice of good personal hygiene can do much to improve personal and family health and wellbeing.***

***So there is an urgent need for the construction of simple, low cost, affordable toilets that are easy to build and maintain and are relatively free of odours and flies.***

***This booklet describes how to make a toilet which is both low cost and easy to make. Builders and artisans are not required, once the householder has learned the basic methods of construction.***

***To start all that is required is part of a bag of cement (between one eighth (5 litres) and one quarter (10 litres) of a 50 kg bag), and some good river sand and thick wire. With this the householder can build a concrete slab which will last for many years. The slab is mounted on a “ring beam” of bricks or concrete and a shallow pit is dug down inside the beam. A simple structure for privacy, made from locally available materials, is then built around the slab.***

***Flies and odours are controlled by regularly adding soil, wood ash and leaves into the shallow pit. By adding the soil, ash and leaves, the excreta in the pit turns into compost. It is possible to grow a tree on this compost, which will later form fruit or supply timber for fuel or building. It is also possible to dig out the compost after a suitable time and use this to fertilise the vegetable garden. So the simple toilet can have many valuable uses!***

***This particular toilet is called an Arborloo because a tree is planted on the filled pit. The Arborloo is then moved to a new place.***

***Over the years it is possible to improve on the original toilet using the same concrete slab. It is a small amount to pay for something that gives so much benefit to the family.***

*The **Arborloo** is the name given to a simple pit toilet.  
It is easy to construct & is cheap to build.  
The **Arborloo** is made up from 4 parts:*

- 1. The **pit***
- 2. The “**ring beam**” to protect the pit*
- 3. The **concrete slab** which sits on the ring beam*
- 4. The **toilet house** which surrounds the slab.*

*The **Arborloo** pit fills up with a mix  
of excreta, soil, wood ash and leaves.*

*Leaves are put in the base of the pit before use and  
every day some soil and wood ash are added to the pit.  
Dry leaves are also added to the pit.*

*No garbage is put down the **Arborloo** pit*

*When soil, ash and leaves are added to excreta, it  
changes quite fast into compost. The daily addition of  
soil and ash also helps to control flies and smells.*

*When the **Arborloo** pit is full, the toilet is moved  
to another place and a thick layer of soil and leaves is  
placed over the pit contents*

*A young tree is planted in this soil and is watered and  
cared for and also protected against animals  
The toilet is used again in the same way in the new  
**Arborloo** site. The same process takes place again.*



*After some years trees will be growing where the toilet was before. A new orchard of fruit trees or a woodlot of gum trees will be growing, using the compost formed from the excreta. In this way our excreta is recycled!.*

## ***HOW TO BUILD THE ARBORLOO***

### ***1. How to make the concrete slab***

*The concrete slab is made with a mixture of cement and good quality river sand with some wire reinforcing.*

*The mould for the concrete slab is made from a ring of bricks laid on levelled ground. The bricks are laid around a circle marked on the ground, one metre in diameter (radius 50cm).*



*A sheet of plastic is laid in the mould*



*The squat hole is made by placing a shaped plastic bucket or shaped bricks in the slab mould.*

*A mixture of fresh cement and very good river sand is now made up. The mixture is **5 litres of fresh cement and 30 litres clean river sand.***

*If the cement is not fresh or the river sand is not clean it is best to make a stronger mix of 10 litres of cement and 30 litres of river sand.*

*This is mixed thoroughly in a wheel barrow before adding water.*



*The sand and cement must be very well mixed. After mixing the dry sand and cement add water (about 2 - 3 litres) to make a stiff mix. Mix thoroughly again. Add half the mix to the slab mould and spread out evenly*



*Add 4 reinforcing wires each 3 to 4mm in diameter and 90cm long in a square shape around the squat hole. Then add the rest of the concrete mixture. Spread out evenly. Also ram down hard with a wooden float. Smooth off with a steel trowel. Add two thick wire handles on either side for lifting.*

*After 3 hours take out the bricks (or bucket) from the squat hole and make the edges neat with a trowel*



*Cover the slab with a plastic sheet overnight.*

*The following morning - wet down the slab and cover again.  
The slab must be kept covered and wet for **10 days** before moving*

## ***2. How to make the ring beam***

*The ring beam helps to keep the top of the pit from falling in. It supports the concrete slab and soil taken from the pit is rammed in place around it to make the toilet safer.*

*The ring beam can be made of bricks and anthill mortar or it can be made from concrete made with a mix of cement and clean river sand.*

*It is important to raise the toilet base above ground level.*

*The ring beam is made on slightly raised ground where the toilet is to be built.*

### ***2a. How to make the brick ring beam***

*Get some fired farm bricks and mark a circle on the ground 80cm in diameter (radius 40cm). Lay the bricks around the circle.*





*Now make up some ant hill mortar (Ivhu re pa churi) by breaking up ant hill soil and mixing with water.*

*Using a trowel add the anthill mortar between and above the bricks. Then add a second layer of bricks on the first layer. The upper layer of bricks should sit on the joint between bricks of the first course. Use the anthill mortar to hold all the bricks together.*



*Then dig out the pit inside the ring beam down to 1 metre or even 1.5 metres below ground level. Some of the soil which comes out of the pit is placed around the ring beam and rammed hard in place. This will help to make the ring beam strong in its place.*



*This ring beam and soil helps to raise the toilet above ground level and stops rain getting into the pit. The ring beam and surrounding soil helps to make the toilet stronger.*

## ***2b. How to make a concrete ring beam***

*If bricks are not available, but we have good river sand and fresh cement we can make a concrete ring beam to place the slab on.*

*The same mixture for making the concrete slab is used to make the concrete ring beam. That is **5 litres of cement and 30 litres of river sand.***

*But the cement must be fresh and the river sand very clean. The measurements and the mixes must be exact and **10 days** curing for the cement is required. If the cement is not fresh or the river sand is not clean it is best to make a stronger mix of 10 litres of cement and 30 litres of river sand.*

*Level off some ground and lay a plastic sheet over the ground. Take some bricks and make two circles of bricks. The concrete ring beam will be made in between the two circles of bricks. Lay the bricks so the outer and inner circles will make a ring beam in between them which is **85cm** inside and **115cm** outside. Thus the width of the ring beam is **15cm** all round. Fill the spaces opened up between inner bricks with wet sand.*



*Once the brick mould has been made, make up the concrete mixture of 5 litres fresh cement with 30 litres good river sand. Mix the dry parts thoroughly first then mix with about 3 litres fresh water. Mix thoroughly again. Add half of this mixture to the mould. Then take a length of 3 – 4mm wire and place above the concrete mix about half way between the inner and outer bricks. Then add the remainder of the concrete mix to the mould and level off with a wooden float.*

*Ram hard down with the wooden float. Steel handles can also be added if required. Finish off with a steel trowel.*

*Cover with plastic sheet and leave overnight. The following morning, wet the ring beam and keep wet and covered for 10 days. After 10 days the ring beam can be lifted and put into place. Dig down the pit inside the ring beam to 1m or more and place soil around the ring beam.*



## *Stages in making and locating the concrete ring beam*



*Fill in spaces between inner circle of brick mould with wet sand. Make the 6:1 mix of clean river sand and fresh cement. Add half the mix, level off and then add the circle of 3 – 4mm wire*



*Add remainder of concrete mix, level off and ram flat with wooden float. Cover with plastic sheet and leave to cure for 10 days. Keep wet at all times. Then move to location on level ground.*



*Dig down hole within the ring beam to at least 1 metre below surface. Place soil around ring beam and ram in place hard. Add leaves to pit base. Lay anthill mortar or weak cement on ring beam and place slab on top. Bed in and level the slab. The structure can now be built around the slab.*



## *Putting the slab and brick ring beam together*

*Once the slab has had time to cure (10 days) and become strong it can be moved into the place where the toilet will be built.*



*First put a big sack full of dry leaves in the pit  
The leaves will help the contents of the pit to compost.  
Then lay the slab over the ring beam*

*It is best to lay the slab in some mortar placed on the ring beam.  
This can be made of anthill mortar or weak cement and sands (20:1).*

## ***Building the toilet house (superstructure)***

*We now build the house over the ring beam and slab with local materials like poles and grass.*



*This house structure is used to make the place private. There are many ways of making the house structure. It is best to make a roof to fit over the structure for shade and to keep the rain out.*

## ***HOW TO USE THE ARBORLOO***

*When using the **Arborloo** we add dry soil, wood ash and leaves to the pit as well as our excreta. This mix of excreta, soil, ash and leaves helps to make good compost in the pit.*

*Add soil and ash after every visit to deposit faeces, about a small cup full of soil and some ash, but not after every visit to add urine. Sometimes add extra leaves.*

*Keep the toilet clean*

*Do not put rubbish down the pit like plastic and rags*

*Use the toilet until the pit is nearly full.*

## ***When the pit is nearly full it is time to move the Arborloo to a new place.***

*We take away the house or take it apart.*

*We remove the concrete slab and ring beam. If it is a brick ring beam  
We take the bricks apart and re-use them in the new site.*

*We cover the contents of the pit with leaves and  
a thick layer (150mm deep) of good soil.*

*We now rebuild the brick ring beam in a new place.  
If we are using the concrete ring beam it just needs to be moved*

*We dig a new pit inside the ring beam and surround the  
ring beam with soil and ram hard.*

*We add a sack of leaves to the bottom of the pit*

*We place the slab on the new ring beam and build the house as before*

*Then we can then start to use the new toilet.*

### ***For the old pit***

*We have covered the pit contents with leaves and plenty of soil*

*We can leave this pit to settle and wait for the rains  
before planting a new young tree*

**OR**

*We can plant a young tree in the soil and look after it. It will  
require protection from animals and frequent watering*



# *Planting trees*



*The first trainees at Kufunda planting a mulberry tree on an Arborloo pit*

*Good trees for this Arborloo pit are mulberry, guava, mango, paw paw and banana. But we can plant many other trees*

*Plant the young tree in the soil above the compost. The young trees must be cared for. They must be protected from animals and must be watered often. In time the tree will grow big and provide many fruits.*

*Once the tree is established we can fertilise the tree with a mix of urine (2 litres) mixed with water (10 litres) and a mug full of wood ash every month to help it grow more.*

*The Arborloo will move about in the garden and will help to make many new trees. It can be used to make a new **orchard** of fruit trees or a **wood lot** of gum trees. It can also be used to make shade or ornamental trees.*

*The time to fill the Arborloo pit depends on the depth of the pit and the number of users. It will be between 6 and 12 months*

*Larger slabs and ring beams can be made for the Arborloo. The slabs can be 1.2 metres in diameter and fit over larger ring beams constructed over pits 1 metre in diameter. Then the pit will take longer to fill up. Larger slabs and ring beams cost more to make because they use more cement. Also if the sand is poor, or the cement is not fresh a stronger mix of sand and cement must be used (like 3:1, 4:1 or 5:1).*

## ***Making compost***

*If we wish to make compost in the pit for use on the vegetable garden, we can use the same small slab and ring beam. But we need to make another two ring beams and put in place so there are a total of 3 ring beams (with pits) in our garden.*

*The slab and toilet house will move from the pit 1 to pit 2 and then to pit 3, as the pits fill up with the mix of excreta, soil, ash and leaves. When pit 3 is full we empty pit 1 of the compost (after 12 months or more of composting). This compost is fertile and can be mixed with garden soil and used to grow vegetables. Mix one part compost with two parts topsoil. Also add leaf compost or garden compost if available. The slab and the house can then be put back on the pit 1 which has been emptied.*

*So we can rotate the slab and toilet between the three pits in the garden. The ring beams stay in place permanently*

*This way we can “harvest” the good compost from each pit every year, and use it to grow better vegetables. It is important that the pit be left for one full year to compost before being dug out. So with our toilet we can grow trees or we can make good compost for the garden.*

## ***UPGRADING***

*The system which has been described is designed to be simple and low cost. The slabs and ring beams are small and are mounted over pits which have a small capacity (about 0.5 cu.m.). This is ideal for the **Arborloo** concept, and even with three small composting pits used on a rotation basis, a never ending source of compost can be made.*

*The ring beam concept works well on a great range of soils, but obviously it will not work in very loose sandy soils. Ring beams of this type must be used with light weight toilet houses, like poles and grass or other light materials. It is very unwise to build a brick house around a pit lined with a ring beam only. The weight of the bricks may lead to pit collapse. Pits should be fully lined with bricks if a*

*brick structure is used. This method however will be unsuitable for the **Arborloo** which is moved often from one location to the other.*

*However once a strong 1 metre diameter slab and matching concrete ring beam have been made, it is possible to use these same components on larger or even brick lined pits in the future.*

*It is possible, for instance, to cast a larger ring beam with an internal diameter of 1 metre and an outer diameter of 1.3 metres using a mix of 6 litres of cement and 35 litres clean river sand. When the pit is dug down to one metre inside this larger ring beam the pit size is increased by about 1.5 times, compared to the 0.85m diameter pit. If the pit is dug down to 1.3 metres, the capacity of the pit is nearly doubled.*

*To use the smaller slab, which has already been made, the smaller ring beam can be placed on the larger ring beam and then the small slab placed on top. In the same way bricks ring beams can be stepped in (corbelled) so that the diameter of the lower courses is greater than the upper courses. This method is used a lot in Malawi.*

*When pits are dug with greater capacity they take longer to fill, and thus the movement of the slab and toilet house needs to take place less often. This may be seen as an advantage to many families. Pits can be dug deeper as well as wider to increase capacity. The conversion of excreta to compost will still take place if generous amounts of soil, wood ash and leaves are placed down the pit together with excreta.*

### **ALTERNATING BETWEEN TWO PITS**

*If the pits are wider in diameter (one metre) and dug deeper (1.2 – 1.5 metres), a family will take a year or more to fill the pit, even when soil, ash and leaves are added. In this case it is possible to make two permanently sited pits and alternate between them at yearly intervals. Fertile compost can be dug out and used on the garden once a year. This is a system called the **Fossa alterna**.*



*A pit 1 metre in diameter and 1.3 metres deep has a capacity of just over one cubic metre, about twice the capacity of an **Arborloo** pit 0.8m in diameter and one metre deep. This capacity is ideal for the use of the **Fossa alterna**. The effect is the same as the system described earlier with three smaller pits used in rotation.*

*With the **Fossa alterna**, it is only necessary to dig two pits, each of one cubic metre capacity, and these two can be used alternately for many years on one site. Once a year the compost is dug out of one pit and the slab and toilet house placed back on the emptied pit. In some cases the two pits can be dug and enclosed inside a single permanent toilet house. This method is popular in Malawi and Mozambique.*

*Once again, plenty of dried leaves are added to the base of the pit before use. Dry soil and wood ash are added to the pit daily and leaves quite often. This mixture together with excreta composts well.*

*The compost dug out of the pit can be mixed with top soils to increase its fertility and humus content. When mixed with poor sandy soils in equal proportions the compost can increase vegetable growth considerably.*

*Using the systems described here it is possible to start off in a very low cost and simple way and over the years upgrade the system to suit the needs of each family.*



*A very neat Arborloo structure and citrus trees growing in Malawi*

*The writer gratefully acknowledges the help and support of Marianne Knuth, Annie Kanyemba and Kufunda Village staff in the production of this booklet.*

# *Compost Toilet*

## *STARTER KIT*

*No. 1*

*How to make a simple pit toilet  
and grow fruit trees*



*Written by Peter Morgan*

## ***Introduction***

***Most of the rural population of Africa do not have access to safe and reliable toilets. A good toilet, together with a safe reliable water supply and the practice of good personal hygiene can do much to improve personal and family health and wellbeing.***

***So there is an urgent need for the construction of simple, low cost, affordable toilets that are easy to build and maintain and are relatively free of odours and flies.***

***This booklet describes how to make a toilet which is both low cost and easy to make. Builders and artisans are not required, once the householder has learned the basic methods of construction.***

***To start all that is required is part of a bag of cement (between one eighth (5 litres) and one quarter (10 litres) of a 50 kg bag), and some good river sand and thick wire. With this the householder can build a concrete slab which will last for many years. The slab is mounted on a “ring beam” of bricks or concrete and a shallow pit is dug down inside the beam. A simple structure for privacy, made from locally available materials, is then built around the slab.***

***Flies and odours are controlled by regularly adding soil, wood ash and leaves into the shallow pit. By adding the soil, ash and leaves, the excreta in the pit turns into compost. It is possible to grow a tree on this compost, which will later form fruit or supply timber for fuel or building. It is also possible to dig out the compost after a suitable time and use this to fertilise the vegetable garden. So the simple toilet can have many valuable uses!***

***This particular toilet is called an Arborloo because a tree is planted on the filled pit. The Arborloo is then moved to a new place.***

***Over the years it is possible to improve on the original toilet using the same concrete slab. It is a small amount to pay for something that gives so much benefit to the family.***



# ***This Compost Toilet Starter Kit***

*contains:*

*8 litres cement to make a concrete slab*

*Instructions for slab making*

*Instructions for construction and use of Arborloo  
and tree planting*

*Two young mulberry trees*



***Your compost toilet Starter Kit***



**The enclosures, cement, trees, instructions.**

# ***The Arborloo toilet***

*The **Arborloo** is the name given to a simple pit toilet.*

*It is easy to construct & is cheap to build.*

*The **Arborloo** is made up from 4 parts:*

- 1. The **pit***
- 2. The “**ring beam**” to protect the pit*
- 3. The **concrete slab** which sits on the ring beam*
- 4. The **toilet house** which surrounds the slab.*

*The **Arborloo** pit fills up with a mix of excreta, soil, wood ash and leaves.*

*Leaves are put in the base of the pit before use and every day some soil and wood ash are added to the pit.*

*Dry leaves are also added to the pit.*

*No garbage is put down the **Arborloo** pit*

*When soil, ash and leaves are added to excreta, it changes quite fast into compost. The daily addition of soil and ash also helps to control flies and smells.*

*When the **Arborloo** pit is full, the toilet is moved to another place and a thick layer of soil and leaves is placed over the pit contents*

*A young tree is planted in this soil and is watered and cared for and also protected against animals*

*The toilet is used again in the same way in the new **Arborloo** site. The same process takes place again.*

*After some years trees will be growing where the toilet was before. A new orchard of fruit trees or a woodlot of gum trees will be growing, using the compost formed from the excreta. In this way our excreta is recycled!.*

# ***HOW TO BUILD THE ARBORLOO***

## ***1. How to make the concrete slab***

*The concrete slab is made with a mixture of cement and good quality river sand with some wire reinforcing.*

*The mould for the concrete slab is made from a ring of bricks laid on levelled ground. The bricks are laid around a circle marked on the ground, one metre in diameter (radius 50cm).*



*A sheet of plastic is laid in the mould*



*The squat hole is made by placing a shaped plastic bucket or shaped bricks in the slab mould. A mixture of fresh cement and very good river sand is now made up.*

*The mixture is*

***8 litres of fresh cement (provided in Starter Kit) and  
30 litres clean river sand.***





*The sand and cement must be very well mixed on the ground or in a wheel barrow. After mixing the dry sand and cement add water (about 2 - 3 litres) to make a stiff mix like porridge. Mix thoroughly again. Add half the mix to the slab mould and spread out evenly*



*Add 4 reinforcing wires each 3 to 4mm in diameter and 90cm long in a square shape around the squat hole. Strong barbed wire will do.*

*Then add the rest of the concrete mixture. Spread out evenly. Also ram down hard with a wooden float. Smooth off with a steel trowel. Add two thick wire handles on either side for lifting.*

*After 3 hours take out the bricks (or bucket) from the squat hole and make the edges neat with a trowel*



*Cover the slab with a plastic sheet overnight.*

*The following morning - wet down the slab and cover again.  
The slab must be covered and kept wet for at least **7 days** before  
moving*

## ***2. How to make the ring beam***

*The ring beam is a ring of bricks or concrete which is placed at the top of the pit. The concrete slab is laid on the ring beam.*

*The ring beam helps to keep the top of the pit from falling in. It also supports the concrete slab, which is raised above the ground level. The pit is dug down inside the ring beam once it has been laid. The soil taken from the pit is rammed in place around the ring beam to make the toilet safer.*

*The ring beam can be made of bricks and anthill mortar or it can be made from concrete using a mix of cement and clean river sand.*

*It is important to raise the toilet base above ground level to avoid flooding during the rainy season.*

*The ring beam is made on slightly raised ground where the toilet is to be built.*

## ***2a. How to make the brick ring beam***

*Get some fired farm bricks and mark a circle on the ground 80cm in diameter (radius 40cm). Lay the bricks around the circle.*



*Now make up some ant hill mortar (Ivhu re pa churi) by breaking up ant hill soil and mixing with water.*



*Using a trowel add the anthill mortar between and above the bricks. Then add a second layer of bricks on the first layer. The upper layer of bricks should sit on the joint between bricks of the first course. Use the anthill mortar to hold all the bricks together.*





*Then dig out the pit inside the ring beam down to 1 metre or even 1.5 metres below ground level. Some of the soil which comes out of the pit is placed around the ring beam and rammed hard in place. This will help to make the ring beam strong in its place.*



*This ring beam and soil helps to raise the toilet above ground level and stops rain getting into the pit. The ring beam and surrounding soil helps to make the toilet stronger.*

***IT IS IMPORTANT TO MAKE THE RING BEAM FIRST  
BEFORE DIGGING THE PIT***

***THE PIT IS DUG INSIDE THE RING BEAM***

***SOIL TAKEN FROM THE PIT IS PLACED AROUND  
THE RING BEAM AND RAMMED HARD IN PLACE***

## ***2b. How to make a concrete ring beam***

*If bricks are not available, but we have good river sand and fresh cement we can make a concrete ring beam to place the slab on.*

*The same mixture for making the concrete slab is used to make the concrete ring beam. That is **5 litres of cement and 30 litres of river sand**.*

*But the cement must be fresh and the river sand very clean. The measurements and the mixes must be exact and **10 days** curing for the cement is required. If the cement is not fresh or the river sand is not clean it is best to make a stronger mix of 10 litres of cement and 30 litres of river sand.*

*Level off some ground and lay a plastic sheet over the ground. Take some bricks and make two circles of bricks. The concrete ring beam will be made in between the two circles of bricks. Lay the bricks so the outer and inner circles will make a ring beam in between them which is **85cm** inside and **115cm** outside. Thus the width of the ring beam is **15cm** all round. Fill the spaces opened up between inner bricks with wet sand.*



*Once the brick mould has been made, make up the concrete mixture of 5 litres fresh cement with 30 litres good river sand. Mix the dry parts thoroughly first then mix with about 3 litres fresh water. Mix thoroughly again. Add half of this mixture to the mould. Then take a length of 3 – 4mm wire and place above the concrete mix about half way between the inner and outer bricks. Then add the remainder of the concrete mix to the mould and level off with a wooden float.*

*Ram hard down with the wooden float. Steel handles can also be added if required. Finish off with a steel trowel.*

*Cover with plastic sheet and leave overnight. The following morning, wet the ring beam and keep wet and covered for 10 days. After 10 days the ring beam can be lifted and put into place. Dig down the pit inside the ring beam to 1m or more and place soil around the ring beam.*



## ***Stages in making and locating the concrete ring beam***



*Fill in spaces between inner circle of brick mould with wet sand. Make the 6:1 mix of clean river sand and fresh cement. Add half the mix, level off and then add the circle of 3 – 4mm wire*



*Add remainder of concrete mix, level off and ram flat with wooden float. Cover with plastic sheet and leave to cure for 10 days. Keep wet at all times. Then move to location on level ground.*



*Dig down hole within the ring beam to at least 1 metre below surface. Place soil around ring beam and ram in place hard. Add leaves to pit base. Lay anthill mortar or weak cement on ring beam and place slab on top. Bed in and level the slab. The structure can now be built around the slab.*



## *Putting the slab and brick ring beam together*

*Once the slab has had time to cure (10 days) and become strong it can be moved into the place where the toilet will be built.*



*First put a big sack full of dry leaves in the pit  
The leaves will help the contents of the pit to compost.  
Then lay the slab over the ring beam*

*It is best to lay the slab in some mortar placed on the ring beam.  
This can be made of anthill mortar or weak cement and sands (20:1).*

## ***Building the toilet house (superstructure)***

*We now build the house over the ring beam and slab with local materials like poles and grass.*



*This house structure is used to make the place private. There are many ways of making the house structure. It is best to make a roof to fit over the structure for shade and to keep the rain out.*

## ***HOW TO USE THE ARBORLOO***

*When using the **Arborloo** we add dry soil, wood ash and leaves to the pit as well as our excreta. This mix of excreta, soil, ash and leaves helps to make good compost in the pit.*

*Add soil and ash after every visit to deposit faeces, about a small cup full of soil and some ash, but not after every visit to add urine.  
Sometimes add extra leaves.*

*Keep the toilet clean*

*Do not put rubbish down the pit like plastic and rags*

*Use the toilet until the pit is nearly full.*

***When the pit is nearly full it is time to move the Arborloo to a new place.***

*We take away the house or take it apart.*

*We remove the concrete slab and ring beam. If it is a brick ring beam  
We take the bricks apart and re-use them in the new site.*

*We cover the contents of the pit with leaves and  
a thick layer (150mm deep) of good soil.*

*We now rebuild the brick ring beam in a new place.  
If we are using the concrete ring beam it just needs to be moved*

*We dig a new pit inside the ring beam and surround the  
ring beam with soil and ram hard.*

*We add a sack of leaves to the bottom of the pit*

*We place the slab on the new ring beam and build the house as before*

*Then we can then start to use the new toilet.*

***For the old pit***

*We have covered the pit contents with leaves and plenty of soil*

*We can leave this pit to settle and wait for the rains  
before planting a new young tree*

***OR***

*We can plant a young tree in the soil and look after it. It will  
require protection from animals and frequent watering*



## ***Planting trees***

***This Starter Kit is provided with a young mulberry tree.***



***Mulberries are tasty fruit and are easy to grow. They can be grown from cuttings. Place a cutting in the ground and new roots and also leaves (and fruit) will begin to grow.***



***When you first arrive at your home with this Starter Kit carefully unwrap the young mulberry tree. Prepare a pot or bucket and fill it with good fertile soil. Place the small tree in the pot and keep it watered and protected.***



***It will then grow larger and stronger in preparation for planting on top of the filled Arborloo pit in 6 – 12 months time.***

## *Planting trees in Arborloo pits*



*The first trainees at Kufunda planting a mulberry tree on an Arborloo pit*

*Good trees for this Arborloo pit are mulberry, guava, mango, paw paw and banana. But we can plant many other types of tree. Plant the young tree in the thick layer of soil above the compost. The young trees must be cared for. They must be protected from animals and must be watered often. In time the tree will provide many fruits.*

*Once the tree is established we can fertilise the tree with a mix of urine (2 litres) mixed with water (10 litres) and a mug full of wood ash every month to help it grow more.*

*The Arborloo will move about in the arden and will help to make many new trees. It can be used to make a new **orchard** of fruit trees or a **wood lot** of gum trees. It can also be used to make shade or ornamental trees.*

*The time to fill the Arborloo pit depends on the depth of the pit and the number of users. It will be between 6 and 12 months*

***Larger slabs and ring beams can be made for the Arborloo. The slabs can be 1.2 metres in diameter and fit over larger ring beams constructed over pits 1 metre in diameter. Then the pit will take longer to fill up. Larger slabs and ring beams cost more to make because they use more cement. Also if the sand is poor, or the cement is not fresh a stronger mix of sand and cement must be used (like 3:1, 4:1 or 5:1).***

## ***Making compost***

*If we wish to make compost in the pit for use on the vegetable garden, rather than growing a tree, we can use the same small slab and ring beam. But we need to make another two ring beams and put in place so there are a total of 3 ring beams (with pits) in our garden. This is because the **Arborloo** pit is small and 12 months composting time is required before the humus can be dug out.*

*The slab and toilet house will move from the pit 1 to pit 2 and then to pit 3, as the pits fill up with the mix of excreta, soil, ash and leaves. When pit 3 is full we empty pit 1 of the compost (after 12 months or more of composting). This compost is fertile and can be mixed with garden soil and used to grow vegetables. Mix one part compost with two parts topsoil. Also add leaf compost or garden compost if available. The slab and the house can then be put back on the pit 1 which has been emptied. So we can rotate the slab and toilet between the three pits in the garden. The ring beams stay in place permanently*

*This way we can “harvest” the good compost from each pit every year, and use it to grow better vegetables. It is important that the pit be left for one full year to compost before being dug out. So with our toilet we can grow trees or we can make good compost for the garden.*

## **UPGRADING**

*The system which has been described is designed to be simple and low cost. The slabs and ring beams are small and are mounted over pits which have a small capacity (about 0.5 cu.m.). This is ideal for the **Arborloo** concept, and even with three small composting pits used on a rotation basis, a never ending source of compost can be made. The ring beam concept works well on a great range of soils, but obviously it will not work in very loose sandy soils. Ring beams of this type must be used with light weight toilet houses, like poles and grass or other light materials. It is very unwise to build a brick house around a pit lined with a ring beam only unless the brick wall is built on a sound foundation. The weight of the bricks may lead to pit collapse. Pits*



*should be fully lined with bricks if a brick structure is used. This method however will be unsuitable for the **Arborloo** which is moved often from one location to the other.*

*However once a strong 1 metre diameter slab and matching concrete ring beam have been made, it is possible to use these same components on larger or even brick lined pits in the future.*

*It is possible, for instance, to cast a larger ring beam with an internal diameter of 1 metre and an outer diameter of 1.3 metres using a mix of 6 litres of cement and 35 litres clean river sand. When the pit is dug down to one metre inside this larger ring beam the pit size is increased by about 1.5 times, compared to the 0.85m diameter pit. If the pit is dug down to 1.3 metres, the capacity of the pit is nearly doubled.*

*To use the smaller slab, which has already been made, the smaller ring beam can be placed on the larger ring beam and then the small slab placed on top. In the same way bricks ring beams can be stepped in (corbelled) so that the diameter of the lower courses is greater than the upper courses. This method is used a lot in Malawi.*

*When pits are dug with greater capacity they take longer to fill, and thus the movement of the slab and toilet house needs to take place less often. This may be seen as an advantage to many families. Pits can be dug deeper as well as wider to increase capacity. The conversion of excreta to compost will still take place if generous amounts of soil, wood ash and leaves are placed down the pit together with excreta.*

### **ALTERNATING BETWEEN TWO PITS**

*If the pits are wider in diameter (one metre) and dug deeper (1.2 – 1.5 metres), a family will take a year or more to fill the pit, even when soil, ash and leaves are added. In this case it is possible to make two permanently sited pits and alternate between them at yearly intervals. Fertile compost can be dug out and used on the garden once a year.*

*This is a system called the **Fossa alterna**. It is described in more detail in Starter Kit 2.*

*A pit 1 metre in diameter and 1.3 metres deep has a capacity of just over one cubic metre, about twice the capacity of an **Arborloo** pit 0.8m in diameter and one metre deep. This capacity is ideal for the use of the **Fossa alterna**. The effect is the same as the system described earlier with three smaller pits used in rotation.*

*With the **Fossa alterna**, it is only necessary to dig two pits, each of one cubic metre capacity, and these two can be used alternately for many years on one site. Once a year the compost is dug out of one pit and the slab and toilet house placed back on the emptied pit. In some cases the two pits can be dug and enclosed inside a single permanent toilet house. This method is popular in Malawi and Mozambique.*

*Once again, plenty of dried leaves are added to the base of the pit before use. Dry soil and wood ash are added to the pit daily and leaves quite often. This mixture together with excreta composts well.*

*The compost dug out of the pit can be mixed with top soils to increase its fertility and humus content. When mixed with poor sandy soils in equal proportions the compost can increase vegetable growth considerably.*

*Using the systems described here it is possible to start off in a very low cost and simple way and over the years upgrade the system to suit the needs of each family.*



***A very neat Arborloo structure and citrus trees growing in Malawi***

*The writer gratefully acknowledges the help and support of Marianne Knuth, Annie Kanyemba and Kufunda Village staff in the production of this booklet.*

*In brief*

## **MAKING A CONCRETE SLAB**

*Using the 8 litres of cement provided in this Starter Kit*

- 1. Level piece ground where slab will be made*
- 2. Make circle of bricks one metre in diameter (radius 50cm)*
- 3. Add a mould for the squat hole from bucket or bricks*
- 4. Lay down plastic sheet inside brick circle*
- 5. Mix 8 litres cement with 30 litres clean river sand*
- 6. Mix thoroughly*
- 7. Add enough water to make a concrete mix – not too wet*
- 8. Mix thoroughly*
- 9. Add half the mix within the brick mould and level out*
- 10. Add 4 pieces of thick wire (3-4mm or barbed wire) each 90cms long in a square around the squat hole*
- 11. Add remaining half of the concrete mix and level off*
- 12. Add two handles on each side of the slab with thick wire*
- 13. Smooth down concrete mix with steel trowel*
- 14. When the concrete has started to set carefully remove the squat hole mould and neaten edges around squat hole.*
- 15. Cover the slab with plastic sheet*
- 16. Leave over night to set*
- 17. Pour water over the slab. Cover again with plastic sheet*
- 18. Keep wet for at least 7 days for the concrete to cure*
- 19. After 7 days curing the slab can be lifted and placed on the toilet ring beam. The pit will have been dug down at least one metre deep inside the ring beam (see instructions).*
  
- 20. Build a suitable house around the slab for privacy*
- 21. Add a sack full of leaves down the pit before use*
- 22. Every day add soil and ash to the pit to cover the excreta*
- 23. When the pit is nearly full move the toilet house, ring beam and slab to another site. Dig a new pit inside the ring beam*
- 24. Cover the filled pit with a thick layer of good soil*
- 25. Wait for the rains before planting tree if there is little water.*
- 26. Otherwise plant the tree and pot soil carefully in the thick layer (150mm) of soil above the compost. Cover soil with leaves. Protect from animals and keep watered. Watch the tree grow!*



## BIBLIOGRAPHY

I have used the following books and references as a source of valuable background information.

- Andersson, I., with Esrey, S., Hillers, A., and Sawyer, R.** (2000). *Closing the Loop - Ecological Sanitation for Food Security*. Publications on Water Resources No. 18. Sida.
- Austin, A. & Louiza Duncker** (2002). Urine-diversion ecological sanitation systems in South Africa. SCIR. Pretoria, South Africa.
- Balfour, E.B.** (1943). *The living soil*. Faber and Faber. London.
- Barrett, M., Nalubega, M., & Pedley, S.** (1999). On-site sanitation and urban aquifer systems in Uganda. *Waterlines*. Vol. 17. No.4. 10 - 13.
- Benenson, S.** (1990), *Control of Communicable Diseases in Man*. Fifteenth Edition. American Public Health Association, Washington.
- Breslin, E. D.** (1991). Introducing ecological Sanitation: Some lessons from a small town pilot project in Mozambique. Paper presented at Stockholm Water Symposium, Sweden.
- Breslin, E. D. & dos Santos, F.** (2002) Introducing ecological sanitation in northern Mozambique. Field Work Report of WaterAid. London.
- Bromfield, L.** (1949). *Malabar Farm*. Cassell & Co. Ltd. London.
- Carson Rachel.** (1962). *Silent Spring*. Penguin Books Ltd, Harmondsworth. England
- Clark, G. A.** (1997). Dry sanitation in Morelos, Mexico. *Ecological alternatives in Sanitation*. Water Resources Publication No. 9. Sida, Stockholm.
- Del Porto D. & Steinfield. C.** (1999). *The Composting Toilet System Book*. Concord USA. Centre for Ecological Pollution Prevention. pp. 234.
- Devlin, J.F. & Zettel T.** (Eds), (1999). *Ecoagriculture: Initiatives in Eastern and Southern Africa*. Weaver Press. Harare.
- Epstein, S.** (1995). *Growing fruit trees*. Forestry Commission, Harare, Zimbabwe.
- Eshius, J. & Manschott, P.** (1978). *Communicable Diseases. A manual for rural health workers*. African Medical and Research Foundation. Nairobi.
- Esrey S.A., Gough, J., Rapaport, D., Sawyer, R., Simpson-Hebert, M., Vargas, J., Winblad, U.,(ed).** 1998. Ecological Sanitation. Sida. Stockholm.
- Esrey S.A.** (1999). Nutrition - Closing the Loop. *Proceedings of the Workshop on Ecological Sanitation. Mexico*. October 1999.
- Esrey S.A. & Andersson, I.,** (1999) Environmental Sanitation from an Eco-Systems Approach. *Proceedings of the Workshop on Ecological Sanitation. Mexico*. October 1999.

- Feachem, R.G., Bradley, D.J., Garelick, H., & Mara, D.D.**, (1983). Sanitation and Disease: Health Aspects of Excreta and Wastewater Management (London: John Wiley).
- Gao, XZh, Shen, T., Zheng Y.**, (2002) *Practical Manure Handbook*. Chinese Agricultural Publishing House. Beijing.
- Gough, J.** (1997). El Salvador experiences in dry sanitation. *Ecological alternatives in Sanitation*. Water Resources Publication No. 9. Sida, Stockholm.
- Hills, L. D.** (1981). *Fertility Gardening*. Cameron & Tayleur. London.
- Hopkins, D.A.** (1945). *Chemicals, Humus and the soil*. Faber and Faber Ltd. London.
- Howard, Sir Albert**, (1943). *An Agricultural Testament*. Oxford University Press. London.
- Howard, G.** (1999). On site sanitation and groundwater: The art of balancing unknown risks? *Waterlines*. Vol. 17. No.4. 2 - 5.
- Jenkins, Joseph, C.** (1994) *The Humanure Handbook*. Chelsea Green Publishing Co. PO Box 428, White River Junction, VT. USA.
- Jönsson H.** (1997) Assessment of sanitation systems and reuse of urine. *Ecological alternatives in sanitation*. Publications on Water Resources. No.9. Sida. Stockholm.
- Jönsson H. Stenström TA, Svensson J. and Sundin A.** (1997). Source Separated urine - nutrient and heavy metal content, water saving and faecal contamination. *Water Science and Technology*, 35 (9).
- Manson. T.** (1975) *Tom Manson's New Garden Book*. Pioneer Head (Pvt) Ltd. Salisbury, Rhodesia.
- Manson. T.** (1991) *Tom Manson's Garden Book*. Roblaw Publishers, Harare, Zimbabwe.
- Ministry of Water, Lands and Environment (Uganda).** (2003). Directorate of Water Development. South Western Towns water and sanitation project. Ecological sanitation design and construction manual. .
- Morgan, Peter R.** (1990). *Rural Water Supplies and Sanitation*. Macmillans. London.
- Morgan, Peter R.**, (1999). *Ecological Sanitation in Zimbabwe*. A compilation of manuals and experiences. Vols. 1, II, III and IV. Aquamor Pvt. Ltd. Harare.
- Morgan, Peter R.**, (2003). Eco-sanitation in Phalombe and Thyolo, Malawi. A field report of the activities of COMWASH. Nov. 2003.
- Morgan, Peter R.**, (2003). Ecological Sanitation in Malawi. A report of a visit to WaterAid supported projects in Salima and Embangweni. Nov. 2003.
- Munkhondia, T.** (2003). Quarterly report on the CCAP Eco-sanitation project at Embangweni, Malawi.

**Saywell, D.** (1999) Pollution from on-site sanitation - the risks? what risks? *Waterlines*. Vol. 17. No. 4. 22 - 23.

**Simpson-Hebert, M & Sara Wood,** (1997). *Sanitation Promotion Kit*. WHO. Geneva.

**Smit, J.** (1999). Integrating Urban and Peri-urban Agricultural and Urban Waste Management. Proceedings of the Workshop on Ecological Sanitation. Mexico. October 1999.

**Steinfeld, Carol.** (2004). *Liquid Gold. The lore and logic of using urine to grow plants*. Green Frigate Books, Sheffield, Vermont. USA.

**Stenström, Thor-Axel,** (1999). Health Security in the Re-use of Human Excreta from on-site Sanitation. Proceedings of the Workshop on Ecological Sanitation. Mexico. October 1999.

**Stenström, Thor-Axel,** (2001). Reduction efficiency of index pathogens in dry sanitation compared with traditional and alternative waste water treatment systems. Internet Dialogue on Ecological Sanitation (15 Nov. – 20<sup>th</sup> Dec. 2001).

**Strauss, M. & Blumenthal U. J.** (1990). Use of the human wastes in agriculture and aquaculture - utilization practices and health perspectives. IRCWD, Dubendorf, Switzerland.

**Sykes, Friend.** (1946). *Humus and the Farmer*. Faber & Faber Ltd. London.

**Tompkins, P. and Bird, C.** (1998). *Secrets of the Soil*. Earthpulse Press. Anchorage, Alaska.

**Vinnerås, Björn,** (2002). Possibilities for sustainable nutrient recycling by faecal separation combined with urine diversion. PhD thesis. Swedish University of Agricultural Science. Uppsala, Sweden

**Winblad U. & Kilama W.** (1985) *Sanitation without water*. MacMillan. London.

**Winblad, U.** (1996). Towards an ecological approach to Sanitation. International Toilet Symposium. Toyama. Japan.